

Boundary layer flows in large vessels

Simplified set of Navier Stokes Equations:
Application in Biomechanics

Lagrée Pierre-Yves

Laboratoire de Modélisation en Mécanique
CNRS UMR 7607 -- Université Paris VI
Jussieu

Aim

- simplification of Navier Stokes equations
- thanks to asymptotic theory:
“Boundary Layer”

Aim

- simplification of Navier Stokes equations
- thanks to asymptotic theory:
“Boundary Layer”

Starting from Navier Stokes (Axi)

- we simplify NS to a Reduced set of equations
 - which contains the physical scales,
 - the most important phenomena
- much more simple set of equations: Integral equations (1D)
- cross comparisons in some cases of NS/ RNSP/ Integral

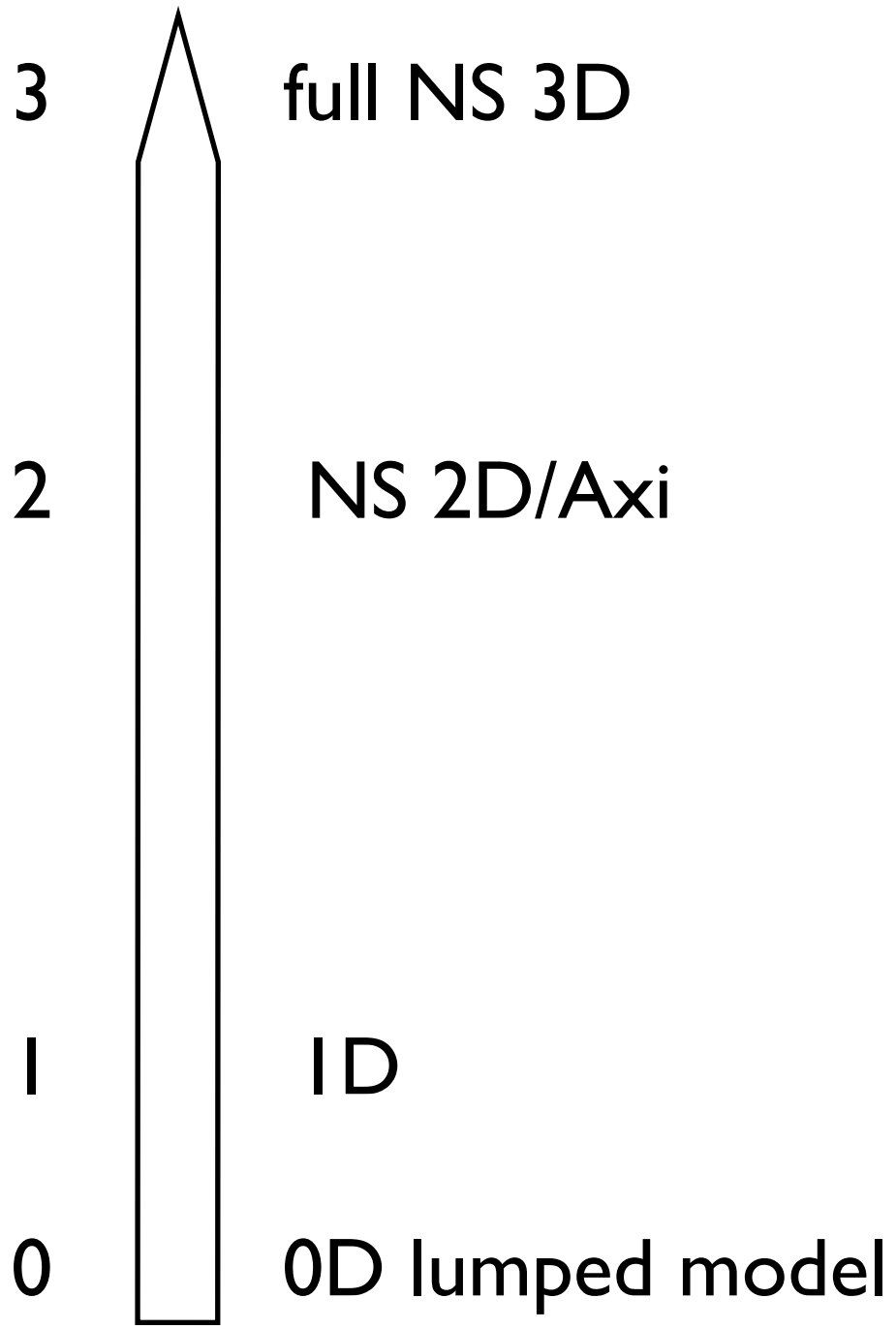

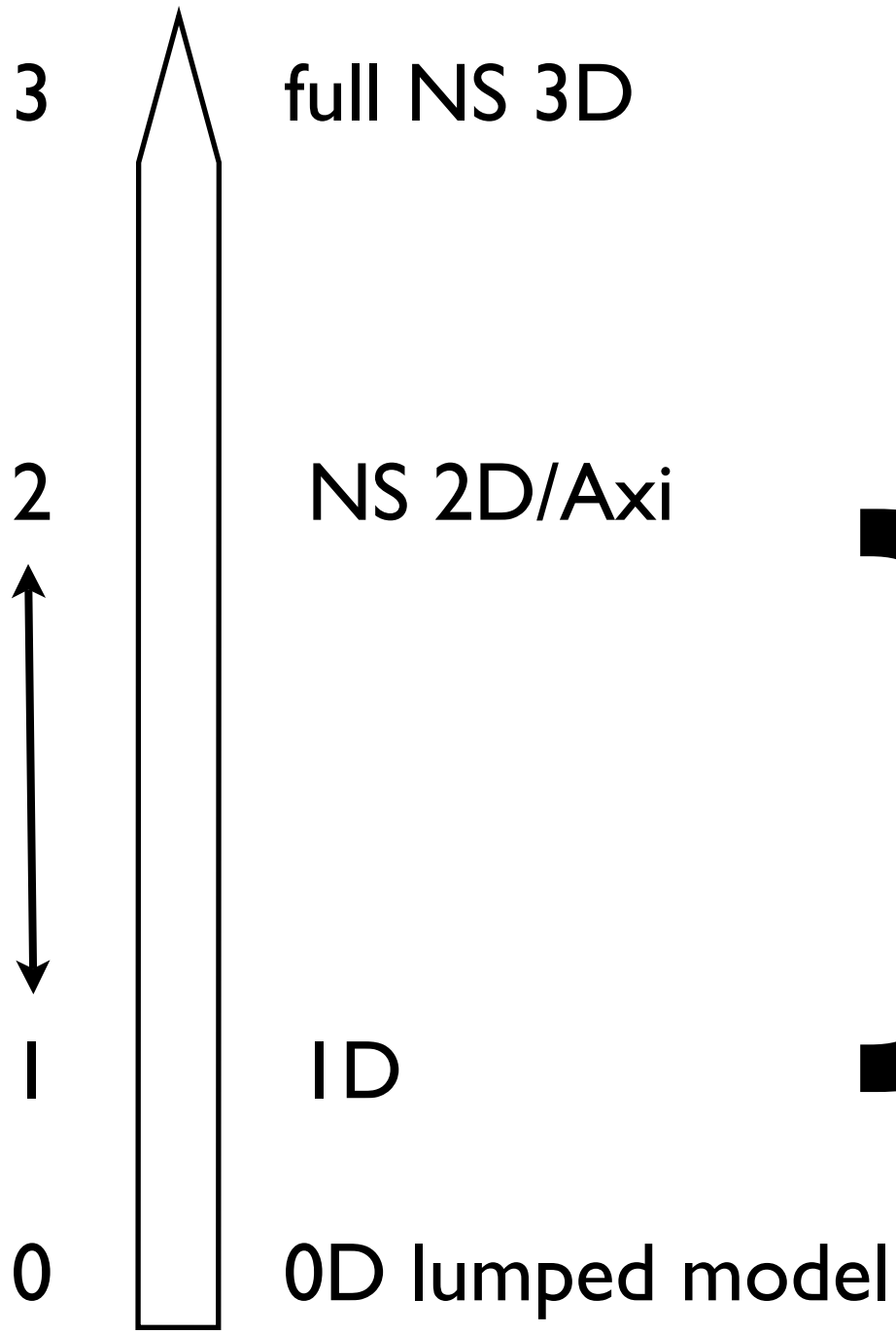

Our model equations

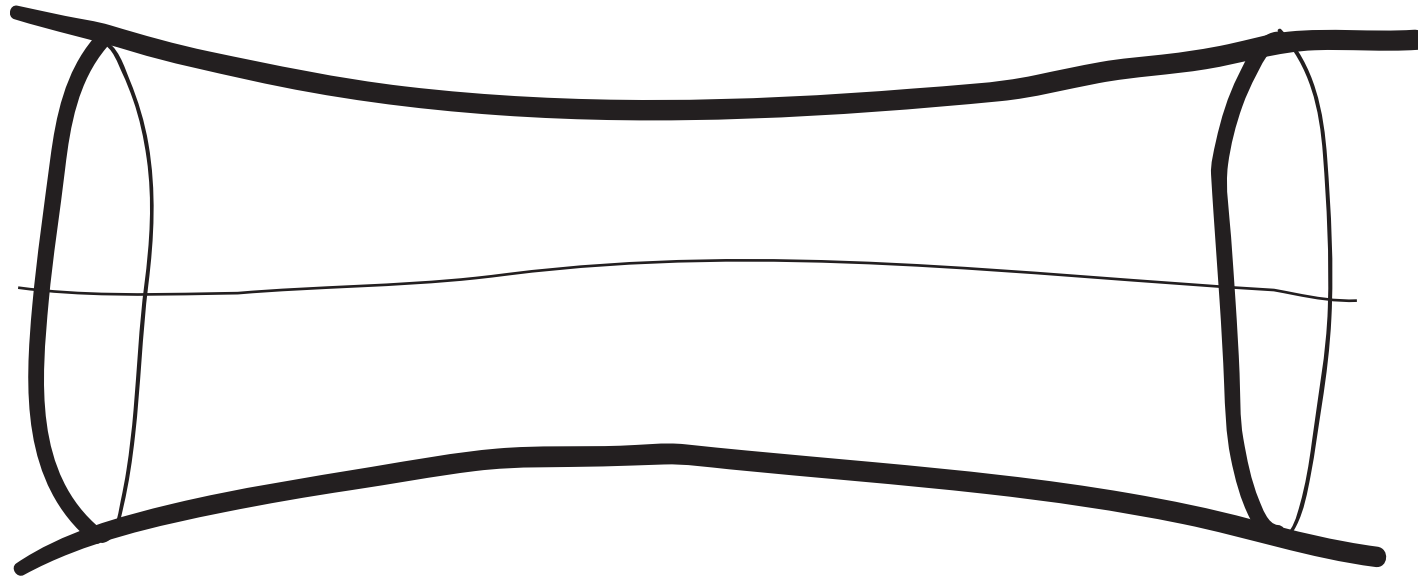

reality?

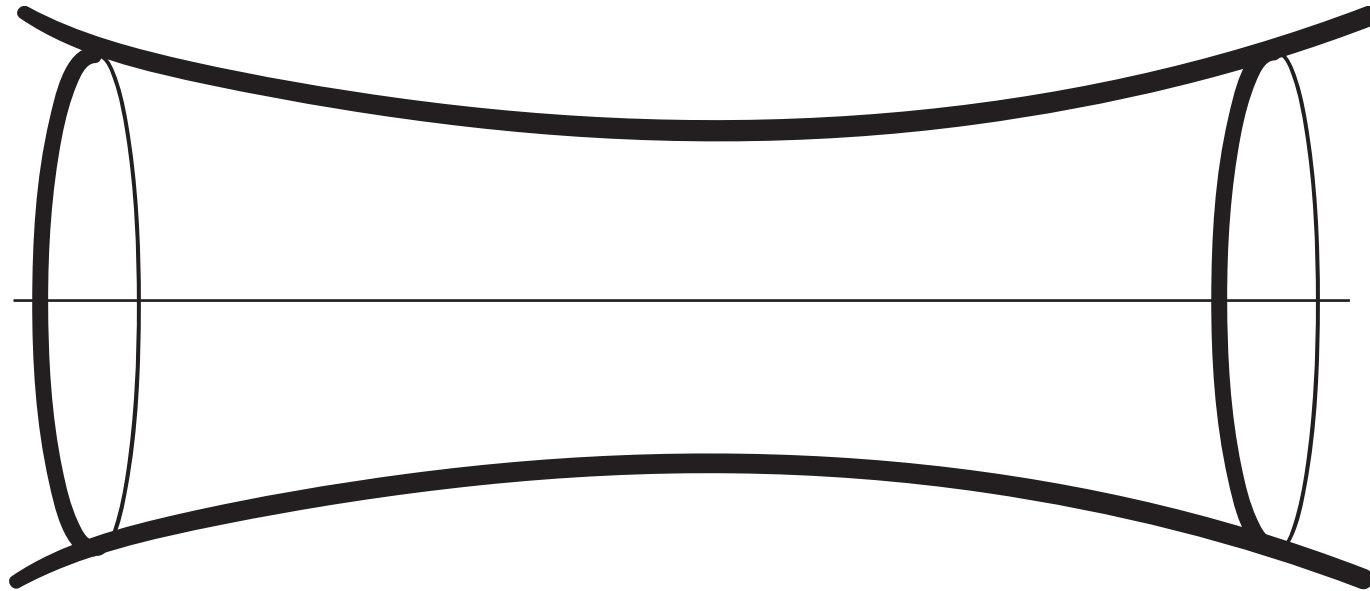

straight pipe, smooth walls, symmetry

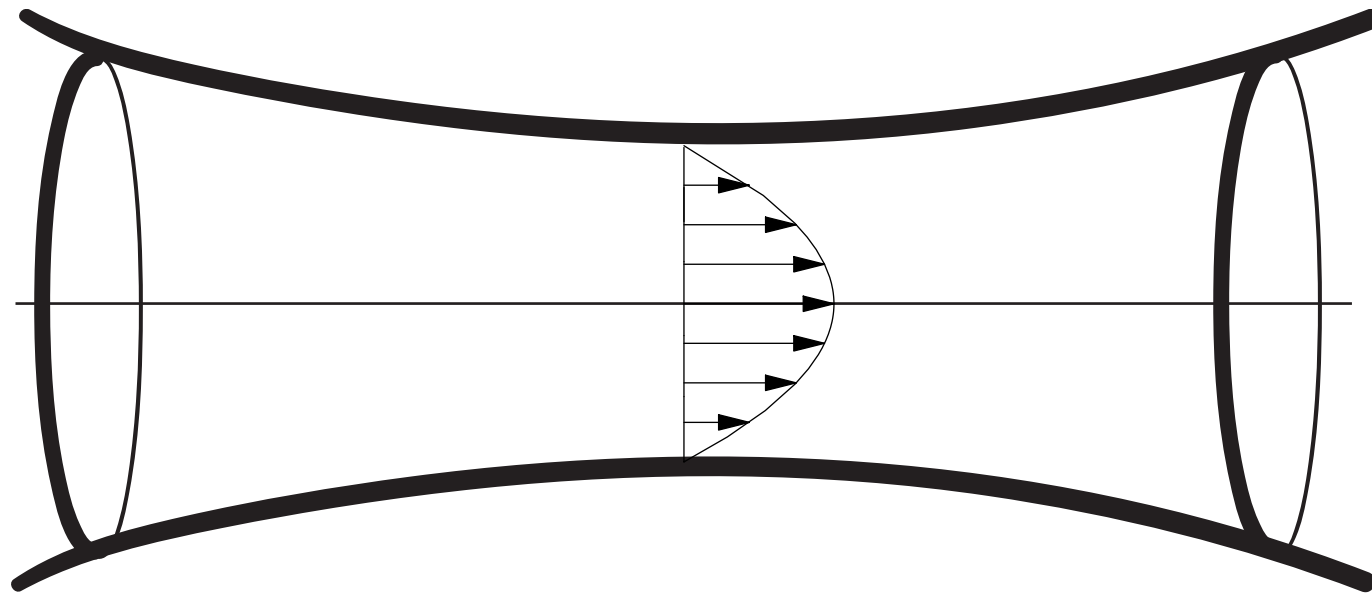

velocity profile

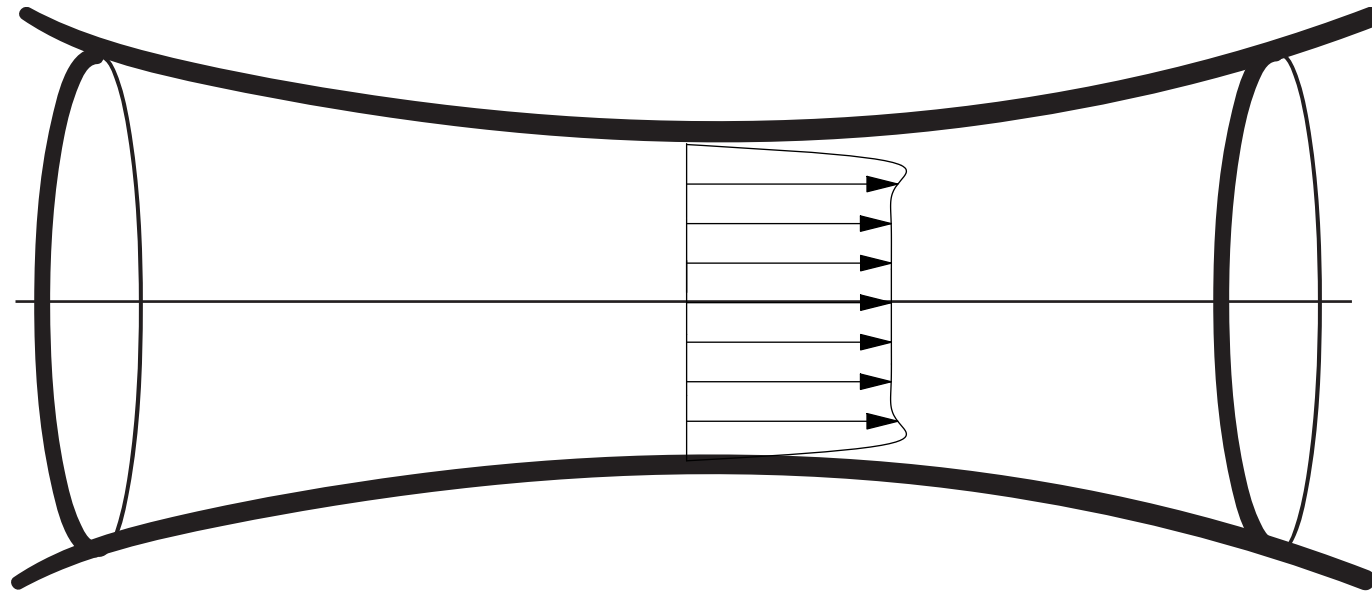

velocity profile

Equations

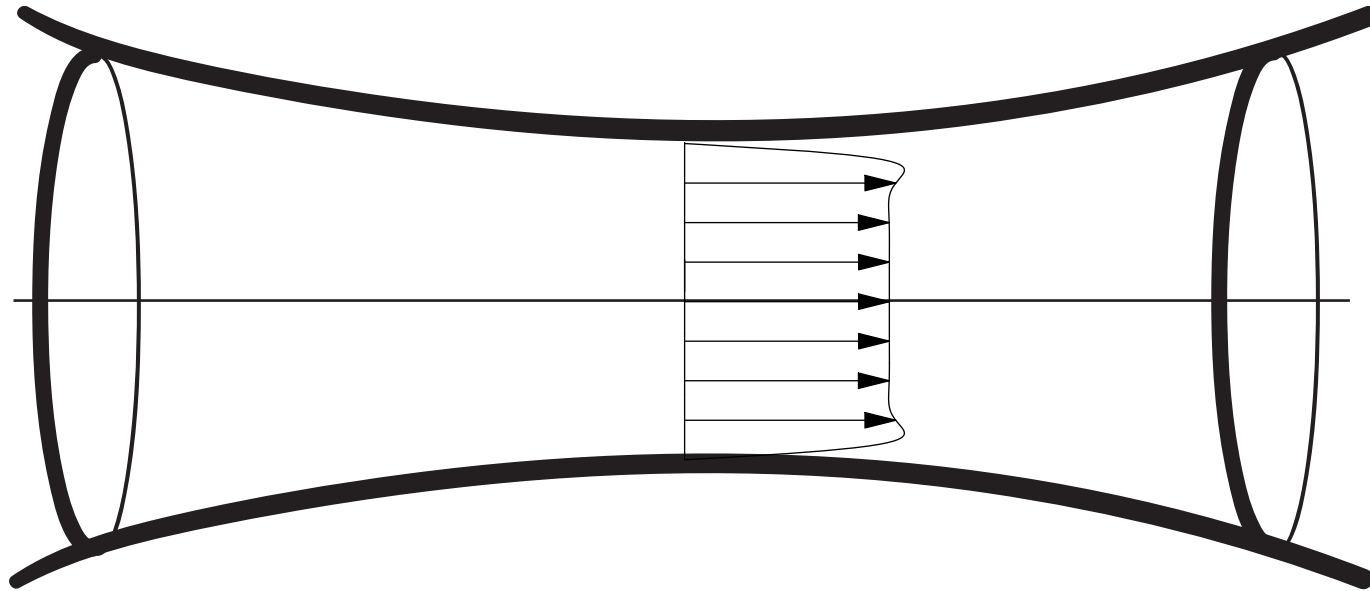

- simplified set
- deduced from orders of magnitude

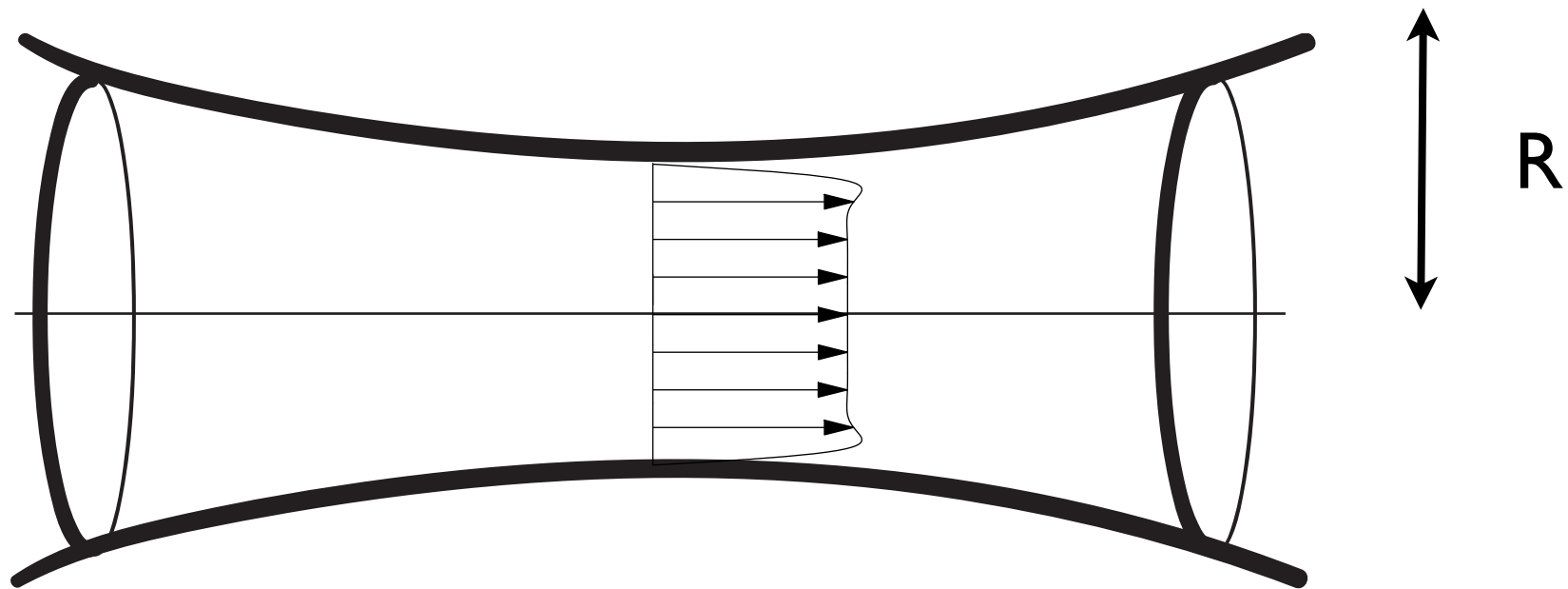

λ

$$R \ll \lambda$$

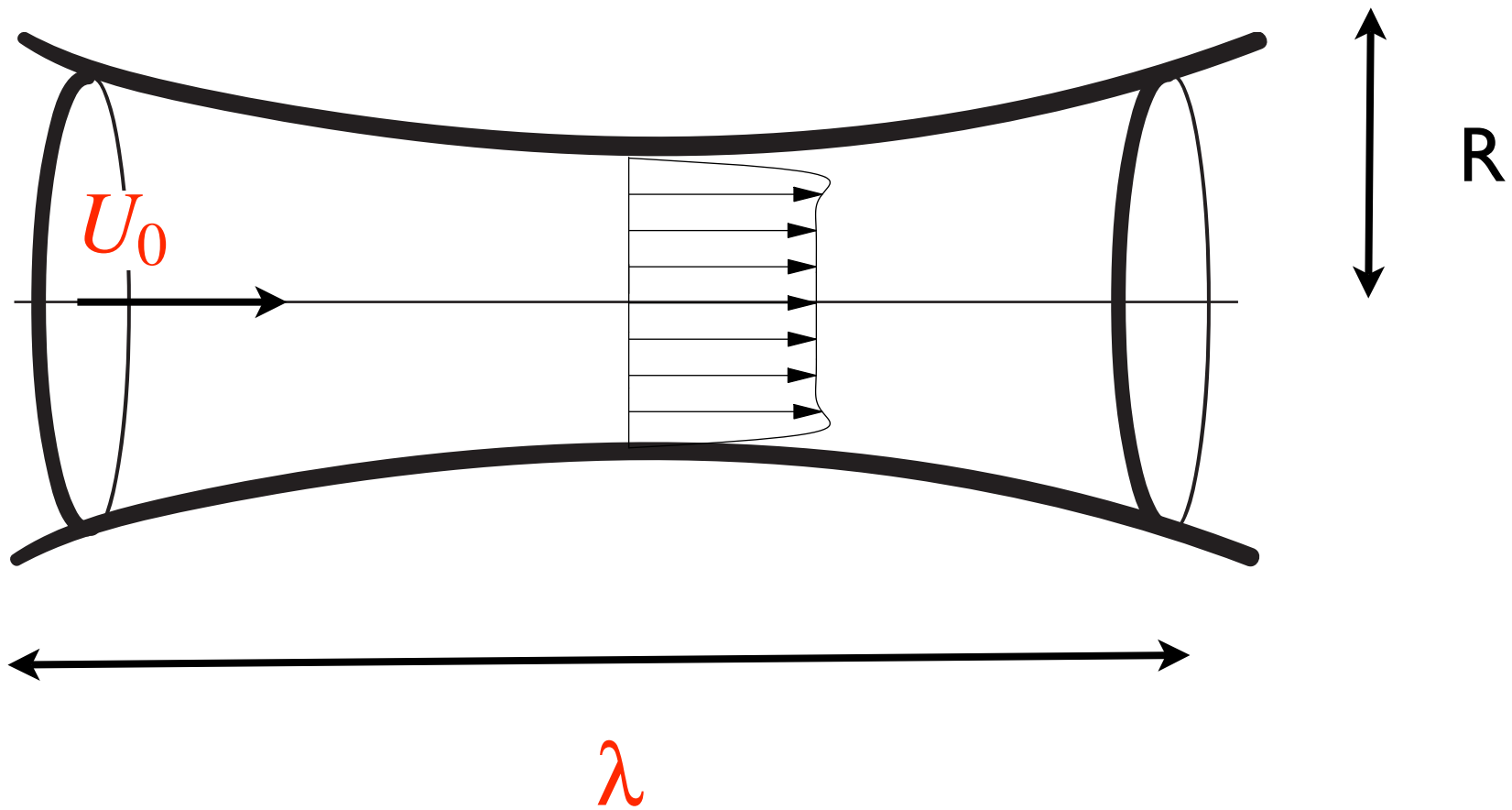

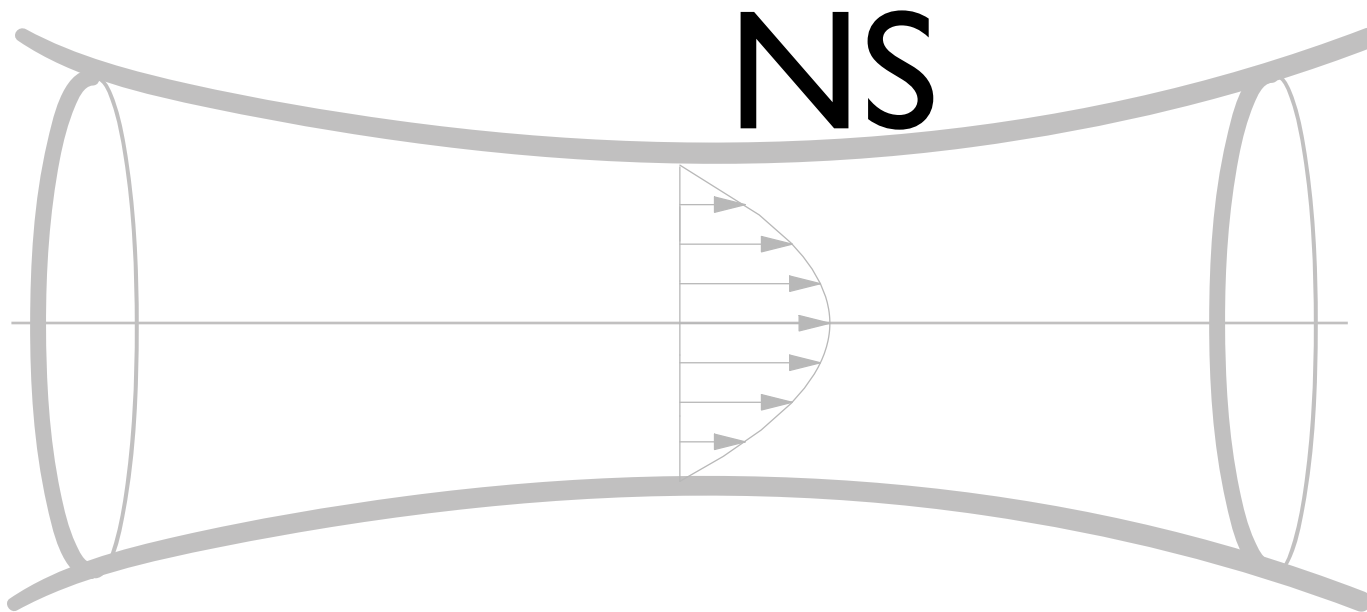

$$\frac{\partial u}{\partial t} + u \frac{\partial}{\partial x} u + v \frac{\partial}{\partial r} u = -\frac{\partial p}{\rho \partial x} + \nu \frac{\partial^2}{\partial x^2} u + \nu \frac{\partial}{r \partial r} r \frac{\partial u}{\partial r}$$

$$\frac{\partial v}{\partial t} + u \frac{\partial}{\partial x} v + v \frac{\partial}{\partial r} v = -\frac{\partial p}{\rho \partial r} + \nu \frac{\partial^2}{\partial x^2} v + \nu \frac{\partial}{r \partial r} r \frac{\partial v}{\partial r}$$

NS

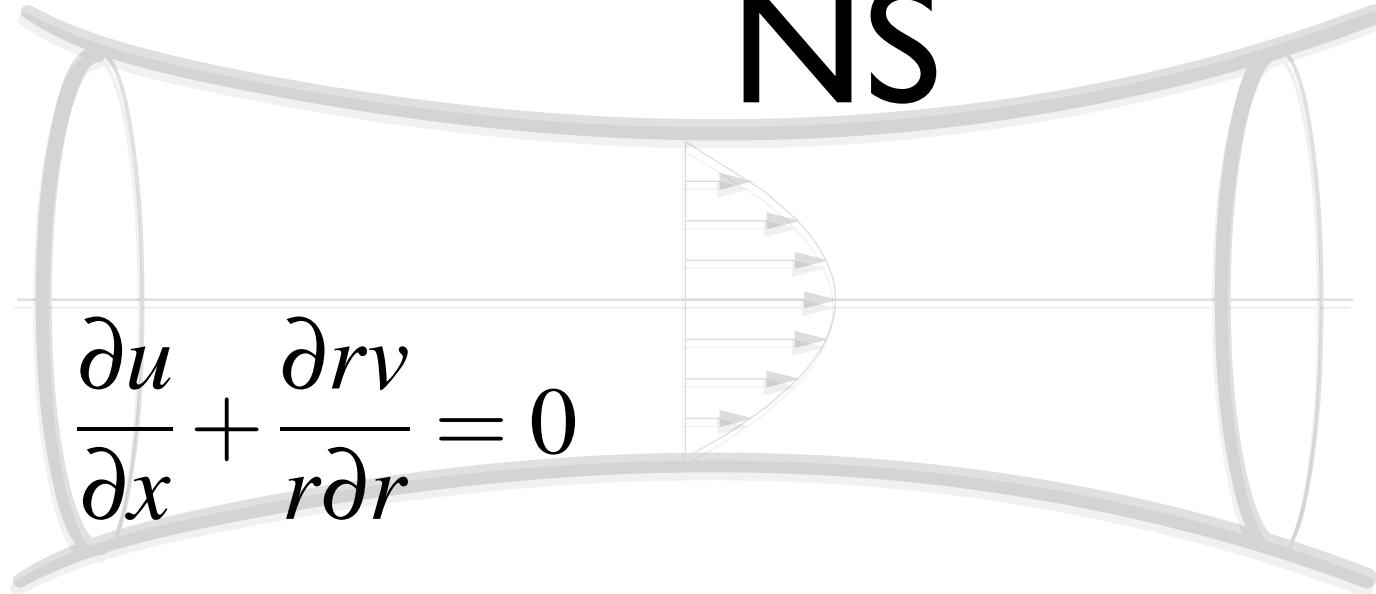

$$\frac{\partial u}{\partial t} + u \frac{\partial}{\partial x} u + v \frac{\partial}{\partial r} u = -\frac{\partial p}{\rho \partial x} + \nu \frac{\partial^2}{\partial x^2} u + \nu \frac{\partial}{r \partial r} r \frac{\partial u}{\partial r}$$

$$\frac{\partial v}{\partial t} + u \frac{\partial}{\partial x} v + v \frac{\partial}{\partial r} v = -\frac{\partial p}{\rho \partial r} + \nu \frac{\partial^2}{\partial x^2} v + \nu \frac{\partial}{r \partial r} r \frac{\partial v}{\partial r}$$

Reduced NS

$$\frac{\partial u}{\partial x} + \frac{\partial rv}{r\partial r} = 0$$

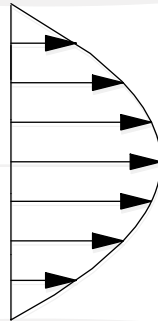

$$R \ll \lambda$$

$$\frac{\partial u}{\partial t} + u \frac{\partial}{\partial x} u + v \frac{\partial}{\partial r} u = -\frac{\partial p}{\rho \partial x} + v \cancel{\frac{\partial^2}{\partial x^2}} u + v \frac{\partial}{r \partial r} r \frac{\partial u}{\partial r}$$

$$\frac{\partial v}{\partial t} + u \frac{\partial}{\partial x} v + v \frac{\partial}{\partial r} v = -\frac{\partial p}{\rho \partial r} + v \cancel{\frac{\partial^2}{\partial x^2}} v + v \frac{\partial}{r \partial r} r \frac{\partial v}{\partial r}$$

RNS/P

$$\frac{\partial u}{\partial x} + \frac{\partial rv}{r\partial r} = 0$$

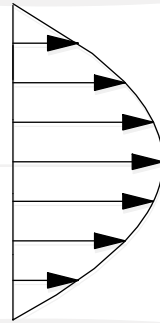

$$R \ll \lambda$$

$$V \sim U_0 \frac{R}{\lambda}$$

$$\frac{\partial u}{\partial t} + u \frac{\partial}{\partial x} u + v \frac{\partial}{\partial r} u = -\frac{\partial p}{\rho \partial x} + v \cancel{\frac{\partial^2}{\partial x^2}} u + v \frac{\partial}{r \partial r} r \frac{\partial u}{\partial r}$$

$$\frac{\partial v}{\partial t} + u \frac{\partial}{\partial x} v + v \frac{\partial}{\partial r} v = -\frac{\partial p}{\rho \partial r} + v \cancel{\frac{\partial^2}{\partial x^2}} v + v \frac{\partial}{r \partial r} r \frac{\partial v}{\partial r}$$

RNS/P

$$\frac{\partial u}{\partial x} + \frac{\partial rv}{r\partial r} = 0$$

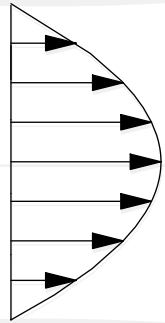

$$R \ll \lambda$$

$$V \sim U_0 \frac{R}{\lambda}$$

$$\frac{\partial u}{\partial t} + u \frac{\partial}{\partial x} u + v \frac{\partial}{\partial r} u = -\frac{\partial p}{\rho \partial x} + v \cancel{\frac{\partial^2}{\partial x^2}} u + v \frac{\partial}{r \partial r} r \frac{\partial u}{\partial r}$$

$$\frac{\partial v}{\partial t} + u \frac{\partial}{\partial x} v + v \frac{\partial}{\partial r} v = -\frac{\partial p}{\rho \partial r} + v \cancel{\frac{\partial^2}{\partial x^2}} v + v \frac{\partial}{r \partial r} r \frac{\partial v}{\partial r}$$

RNS/P

$$\frac{\partial u}{\partial x} + \frac{\partial rv}{r\partial r} = 0$$

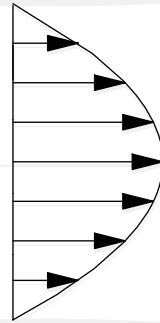

$$R \ll \lambda$$

$$V \sim U_0 \frac{R}{\lambda}$$

$$\frac{\partial u}{\partial t} + u \frac{\partial}{\partial x} u + v \frac{\partial}{\partial r} u = -\frac{\partial p}{\rho \partial x} + v \frac{\partial^2}{\partial x^2} u + v \frac{\partial}{r \partial r} r \frac{\partial u}{\partial r}$$

$$\frac{\partial v}{\partial t} + u \frac{\partial}{\partial x} v + v \frac{\partial}{\partial r} v = -\frac{\partial p}{\rho \partial r} + v \frac{\partial^2}{\partial x^2} v + v \frac{\partial}{r \partial r} \frac{\partial v}{\partial r}$$

RNS/P

$$\frac{\partial u}{\partial x} + \frac{\partial rv}{r\partial r} = 0$$

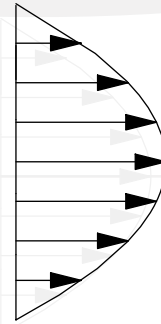

$$\frac{\partial u}{\partial t} + u \frac{\partial}{\partial x} u + v \frac{\partial}{\partial r} u = -\frac{\partial p}{\rho \partial x} + v \frac{\partial}{r \partial r} r \frac{\partial u}{\partial r}$$

$$0 = -\frac{\partial p}{\rho \partial r}$$

RNS/P

$$\frac{\partial u}{\partial x} + \frac{\partial rv}{r\partial r} = 0$$

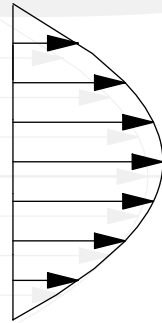

$$v \frac{1}{\omega R^2}$$

$$\frac{\partial u}{\partial t} + u \frac{\partial}{\partial x} u + v \frac{\partial}{\partial r} u = -\frac{\partial p}{\rho \partial x} + v \frac{\partial}{\partial r} \frac{\partial u}{\partial r}$$

$$0 = -\frac{\partial p}{\rho \partial r}$$

RNS/P

$$\frac{\partial u}{\partial x} + \frac{\partial rv}{r\partial r} = 0$$

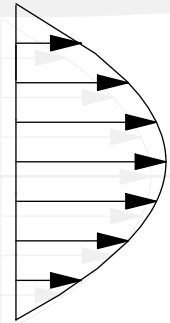

$$\alpha = R \sqrt{\frac{\omega}{\nu}}$$

$$\frac{\partial u}{\partial t} + u \frac{\partial}{\partial x} u + v \frac{\partial}{\partial r} u = -\frac{\partial p}{\rho \partial x} + \nu \frac{\partial}{\partial r} \left(\frac{\partial u}{r \partial r} \right)$$

$$0 = -\frac{\partial p}{\rho \partial r}$$

1/(Womersley)²

RNS/P

Prandtl

$$\frac{\partial u}{\partial x} + \frac{\partial rv}{r\partial r} = 0$$

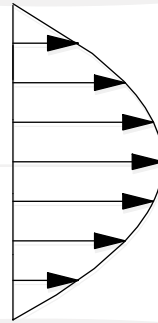

$$\frac{\partial u}{\partial t} + u \frac{\partial}{\partial x} u + v \frac{\partial}{\partial r} u = -\frac{\partial p}{\rho \partial x} + \nu \frac{\partial}{\partial r} r \frac{\partial u}{\partial r}$$

$$0 = -\frac{\partial p}{\rho \partial r}$$

Boundary conditions

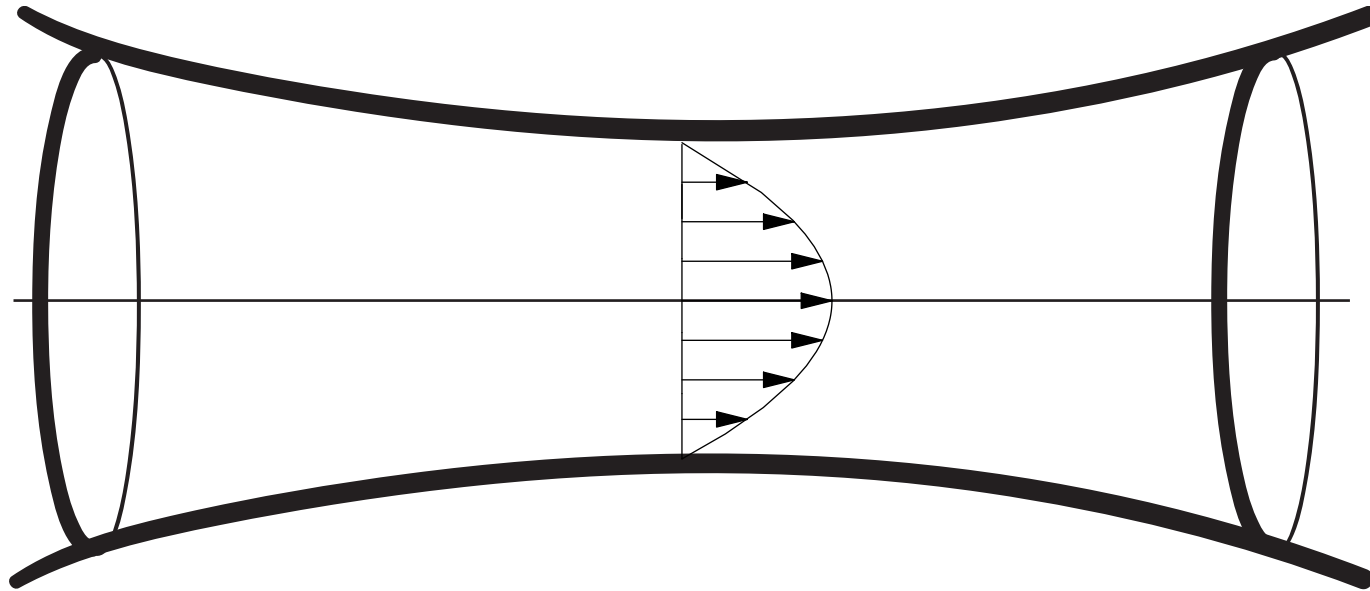

Rigid wall: $u = v = 0$

Boundary conditions

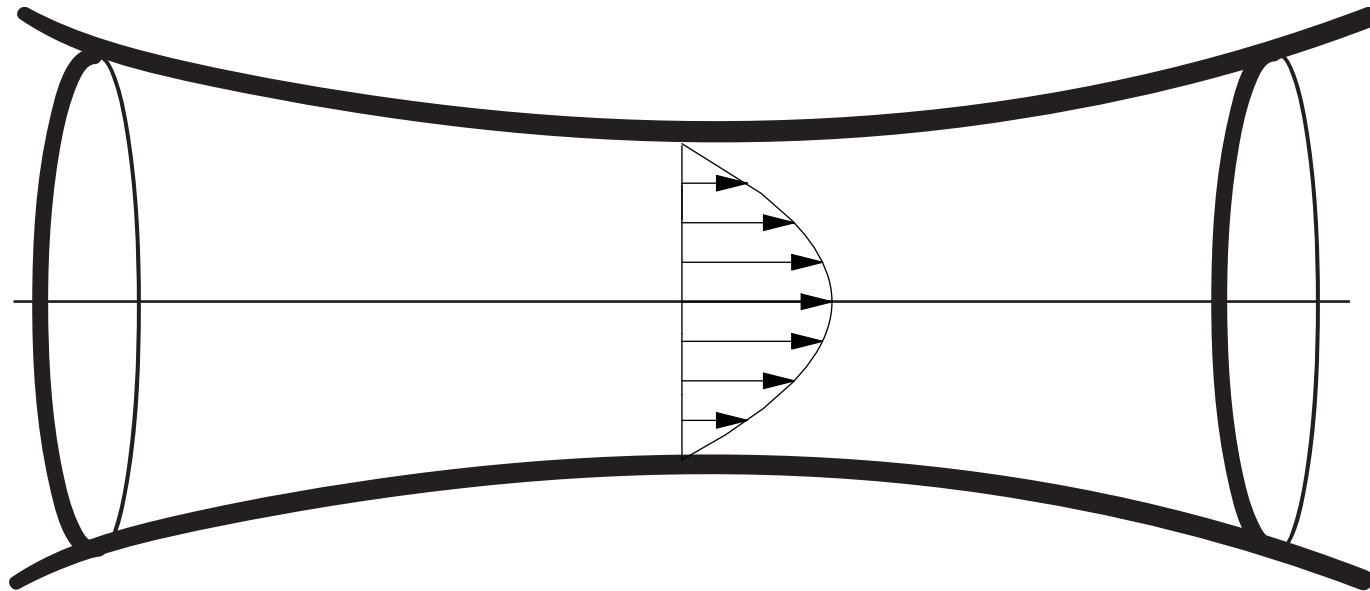

moving wall

Boundary conditions

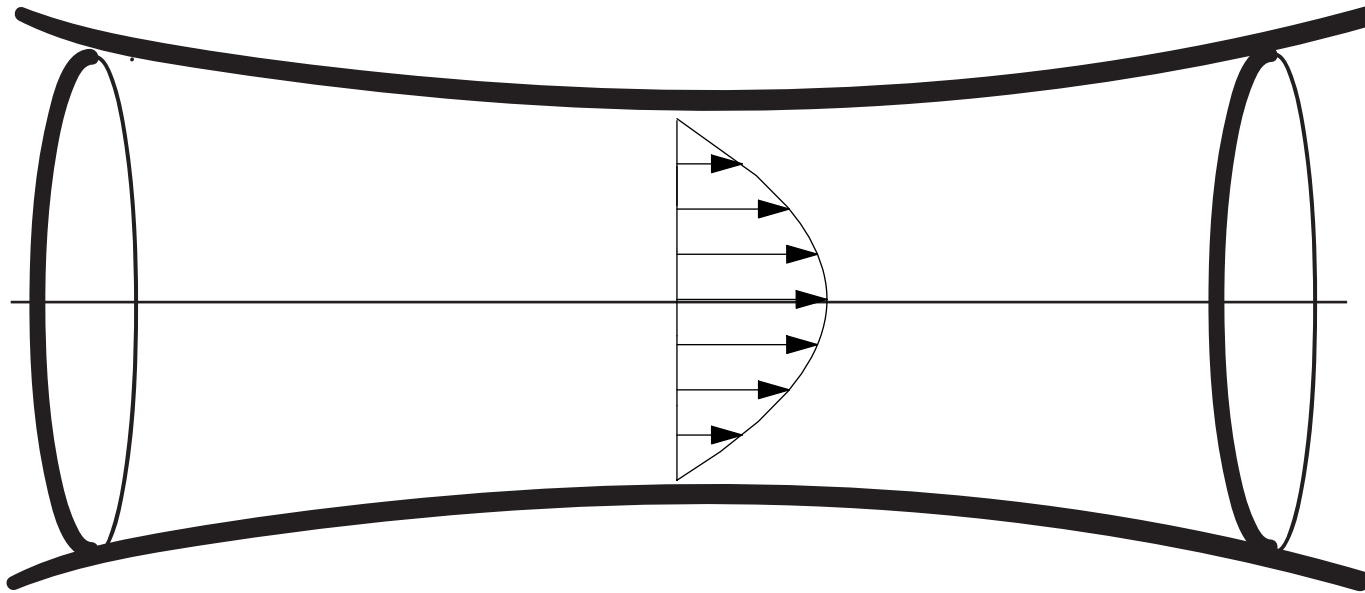

moving wall

Boundary conditions

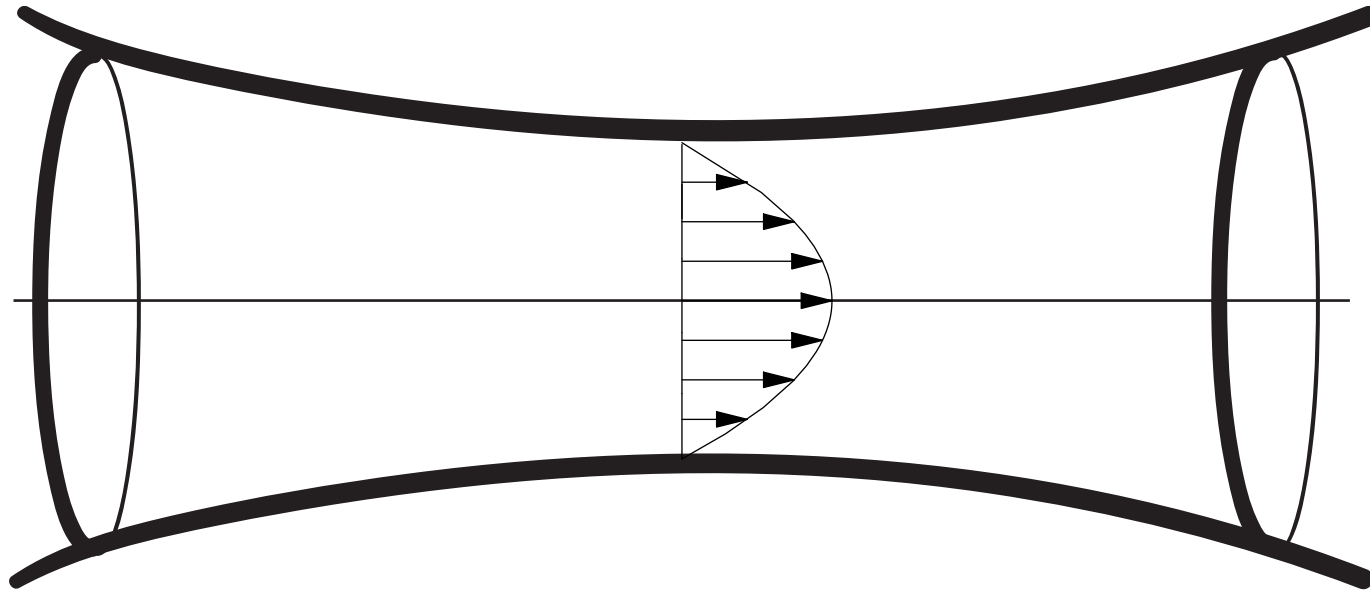

moving wall

Boundary conditions

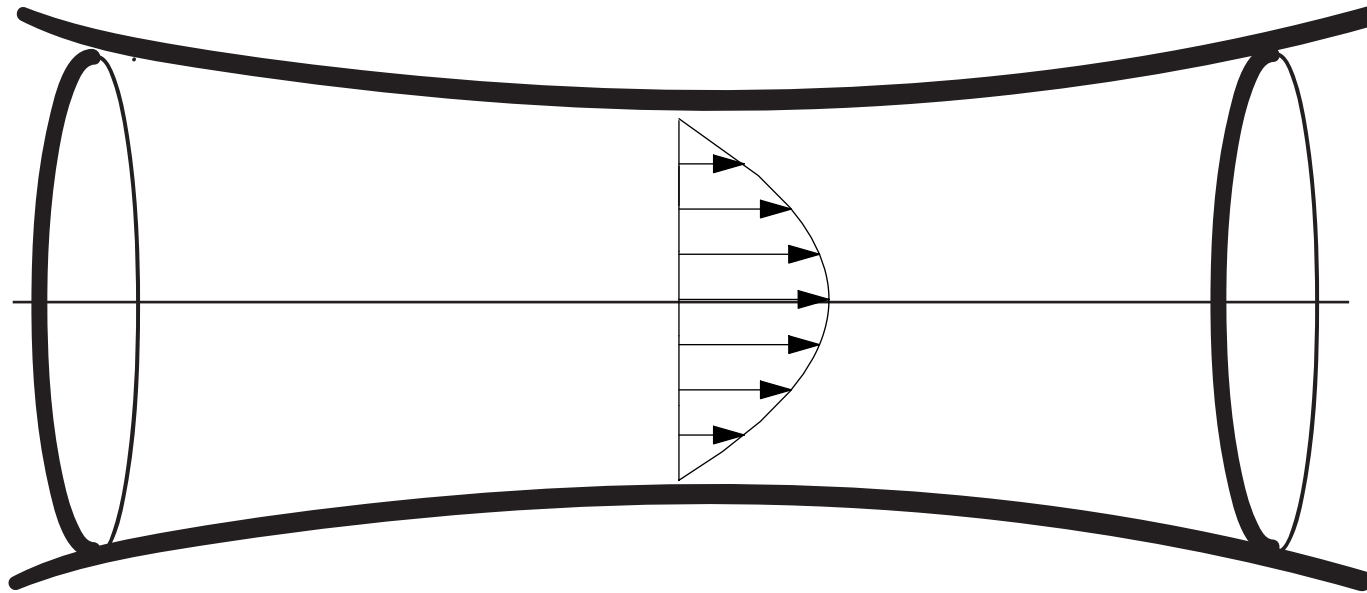

moving wall

Boundary conditions

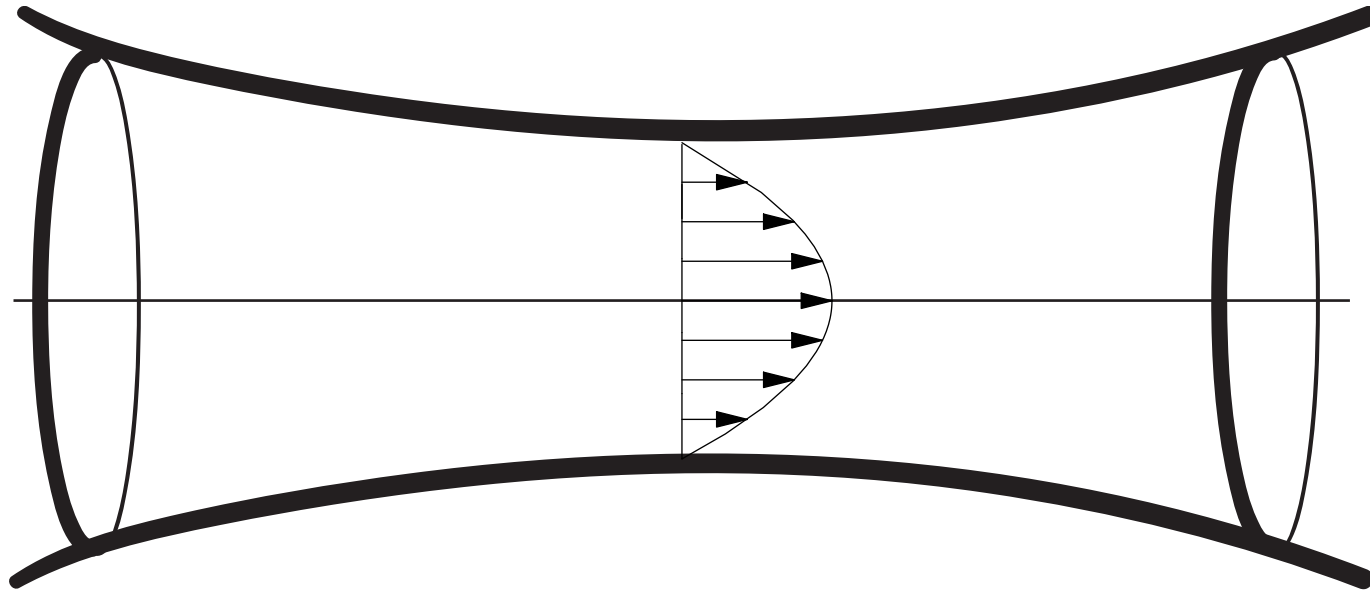

moving wall

Boundary conditions

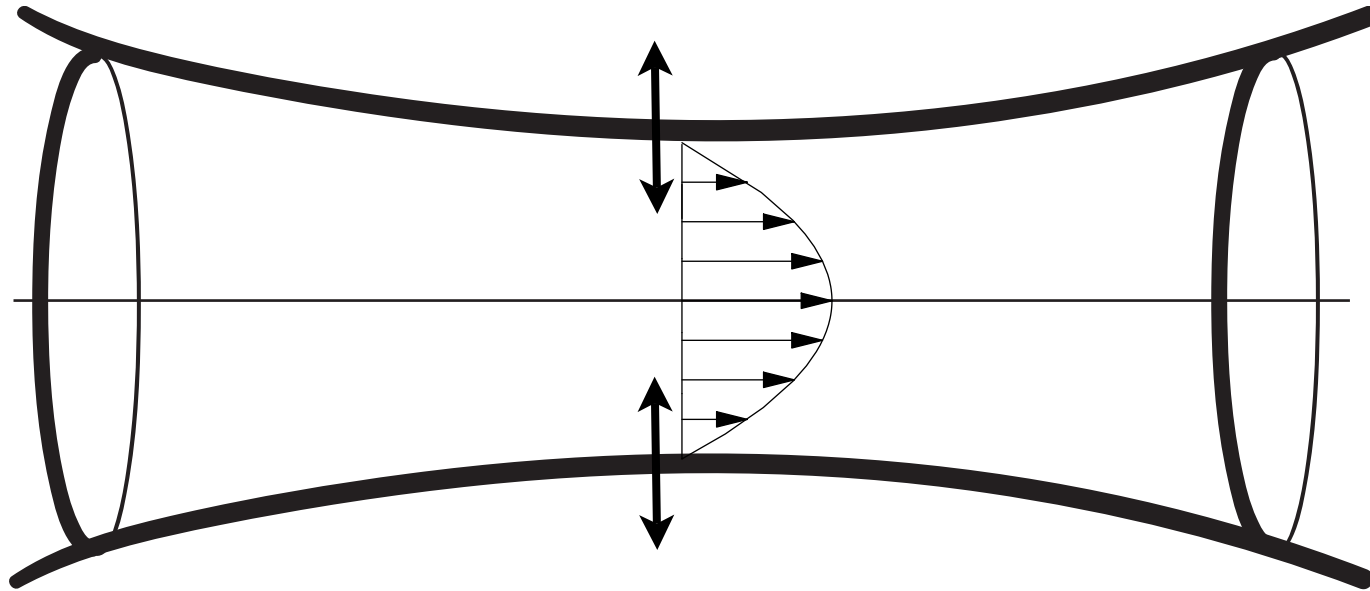

moving wall $v = \frac{\partial R}{\partial t}$

Boundary conditions

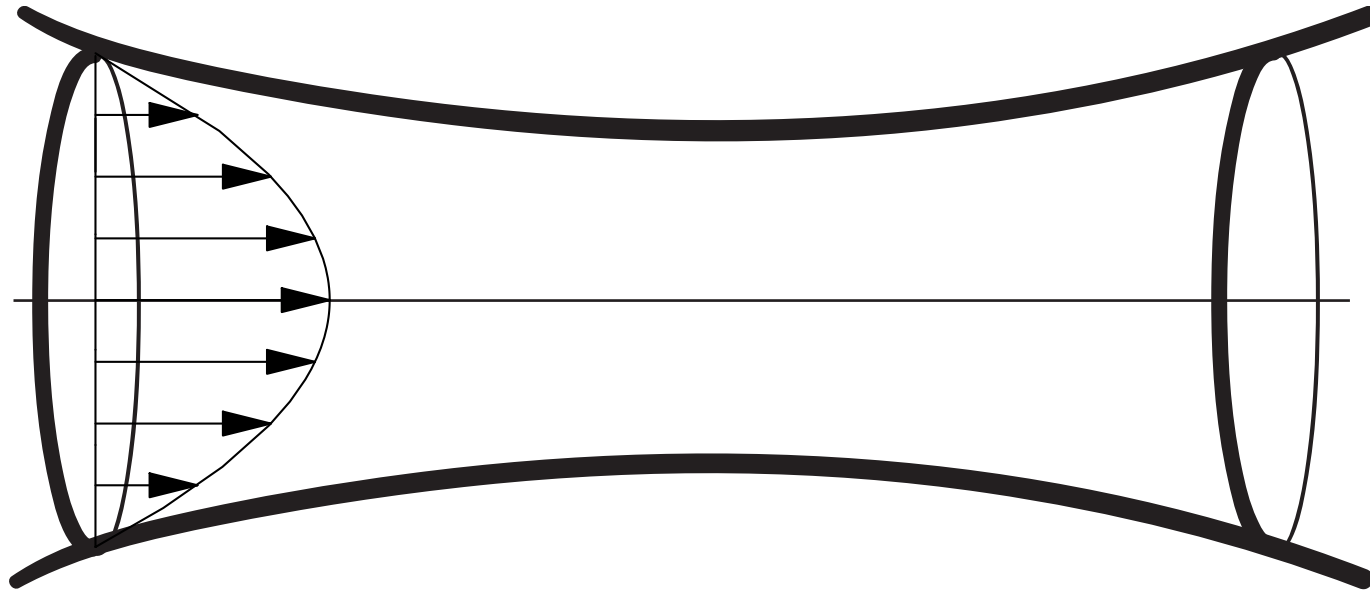

First given profile:

Boundary conditions

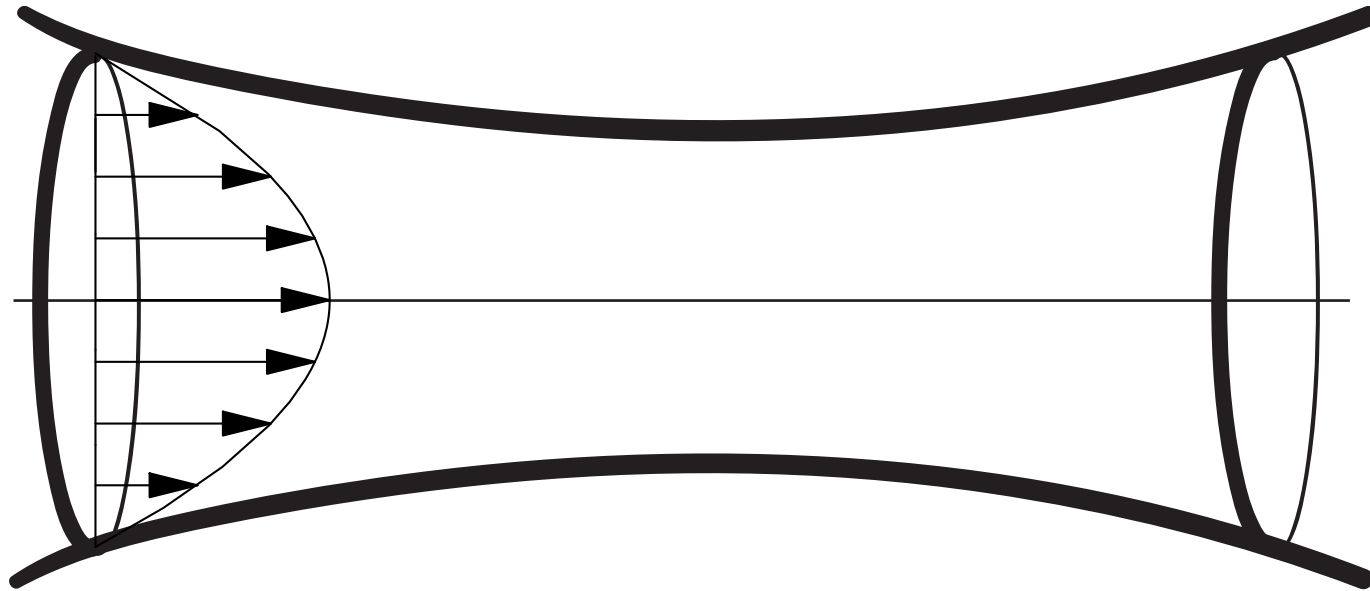

First given profile:

marching procedure



distribution of pressure is a result

Boundary conditions

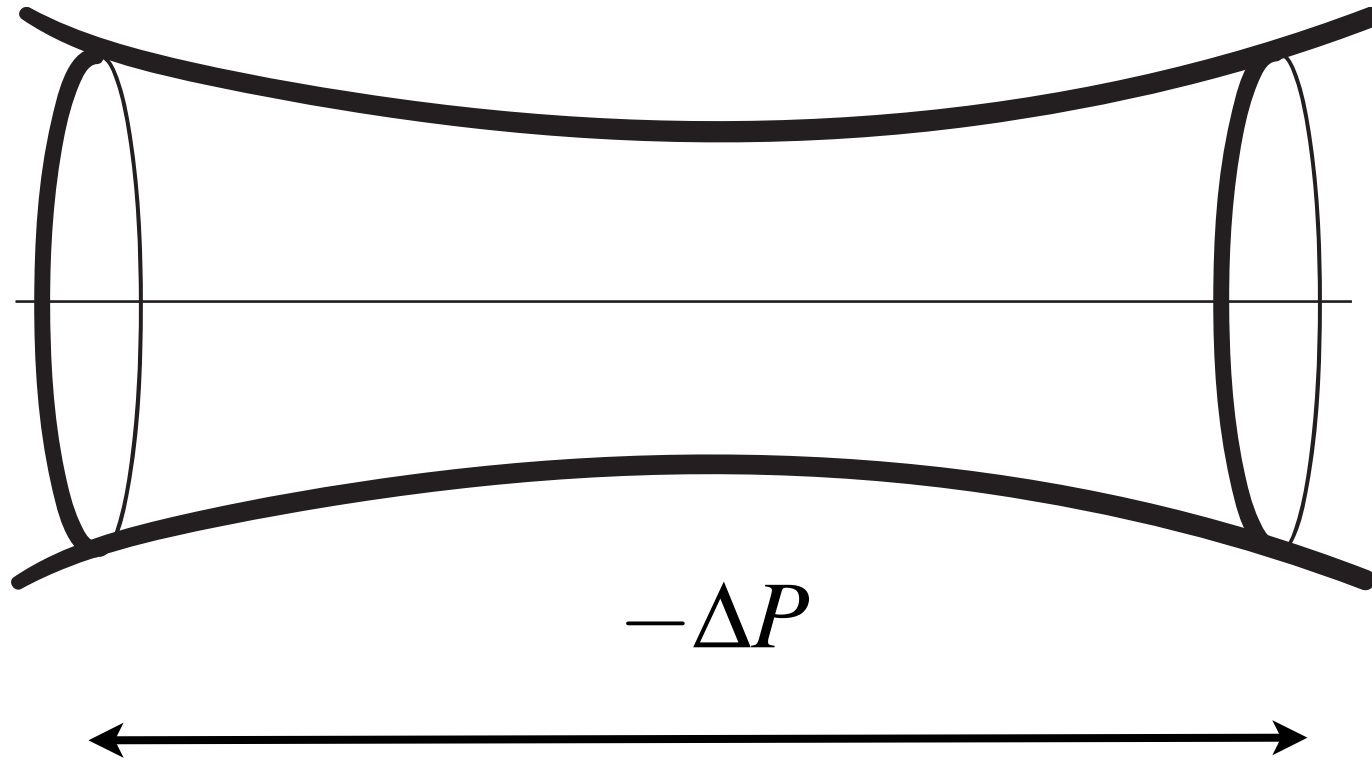

or given pressure drop
by Newton iteration on the entrance flux

Numerical resolution

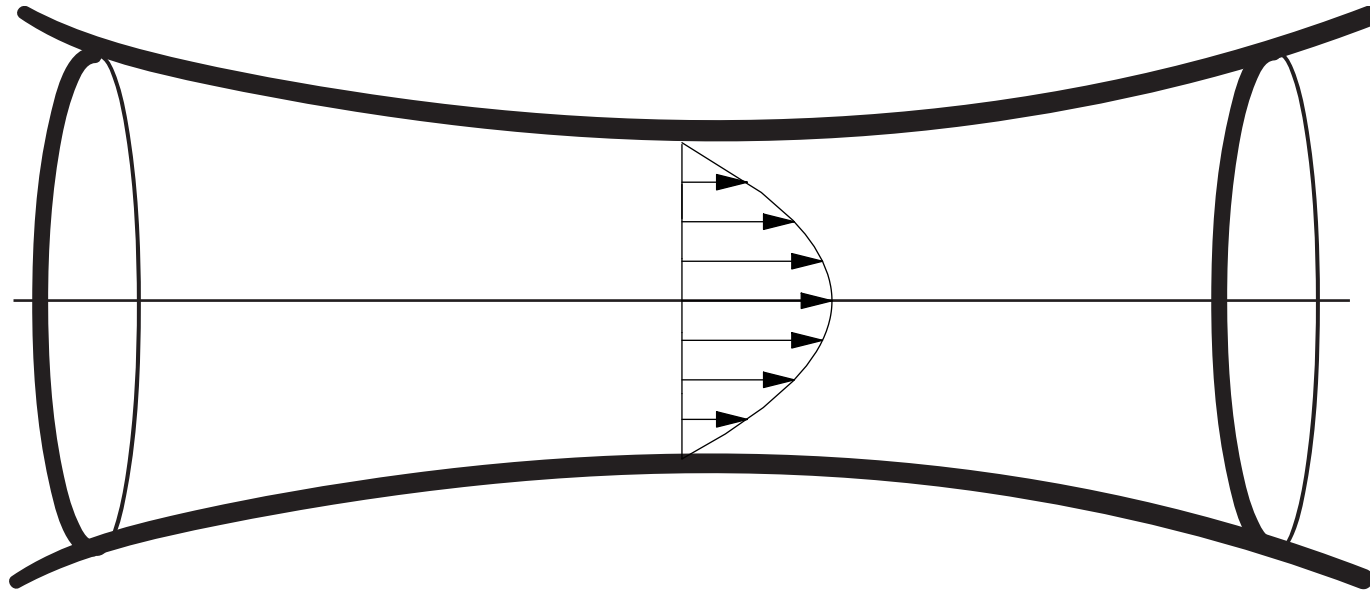

finite differences,
implicit in time

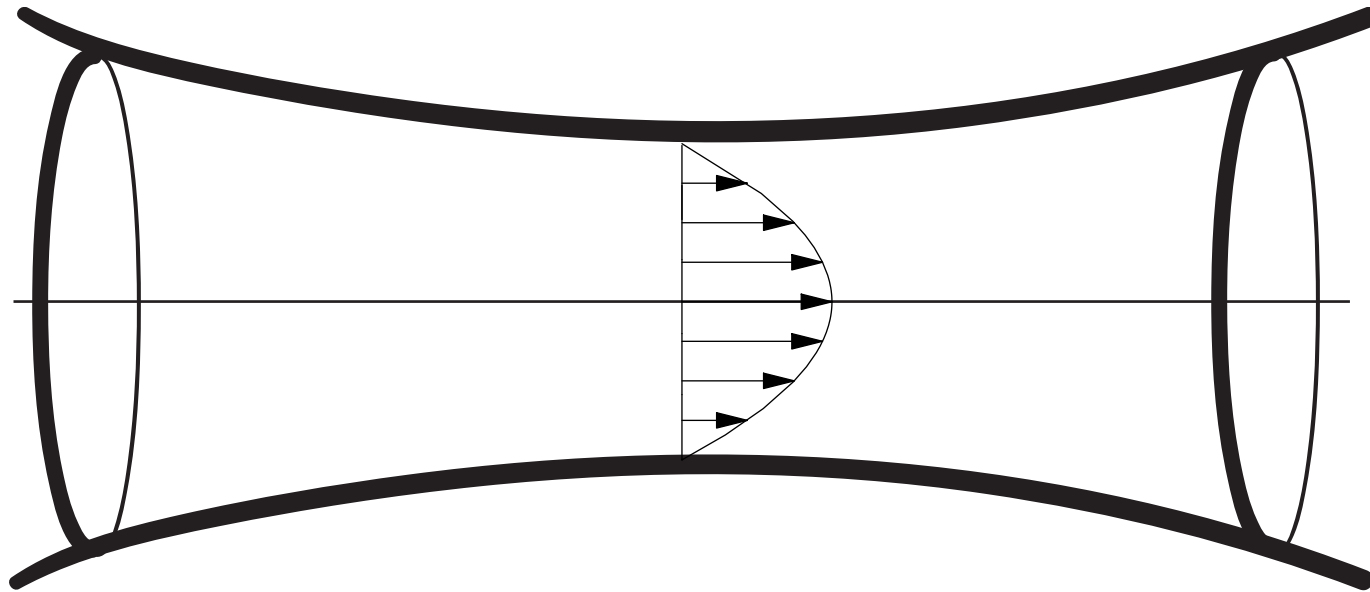

$$\frac{u^* - u^n}{\Delta t} + NL(u^n) = -\frac{\partial p^{\text{given}}}{\partial x} + \frac{\partial}{r \partial r} r \frac{\partial u^*}{\partial r}$$

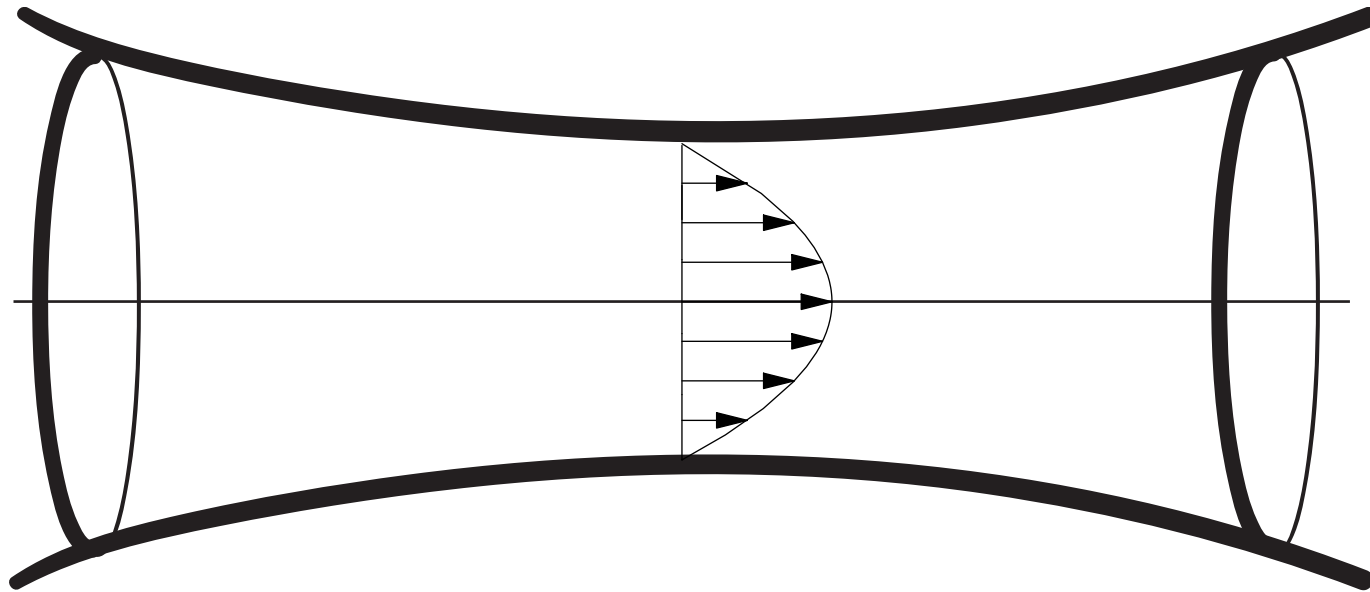

$$\frac{u^* - u^n}{\Delta t} + NL(u^n) = -\frac{\partial p^{\text{given}}}{\partial x} + \frac{\partial}{r \partial r} r \frac{\partial u^*}{\partial r}$$

$$p^{\text{given}} \rightarrow u^*$$

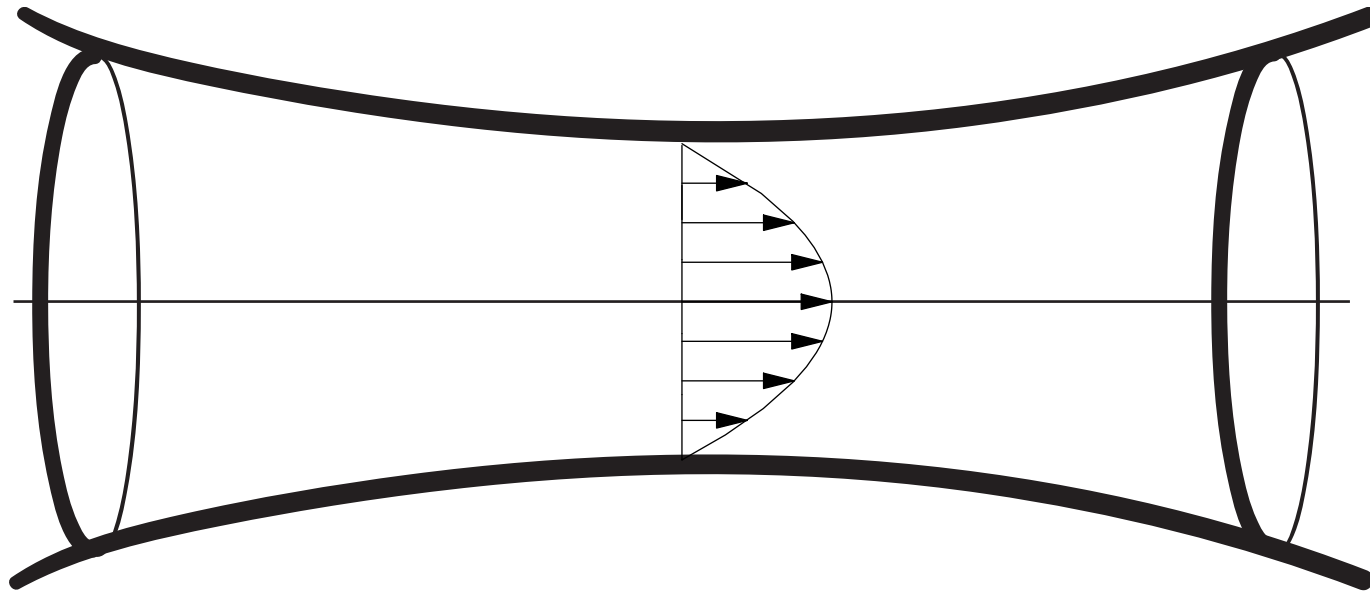

$$\frac{u^* - u^n}{\Delta t} + NL(u^n) = -\frac{\partial p^{\text{given}}}{\partial x} + \frac{\partial}{r \partial r} r \frac{\partial u^*}{\partial r}$$

$$p^{\text{given}} \rightarrow u^* \quad rv^*(R) = - \int_0^R r \frac{\partial u^*}{\partial x} dr$$

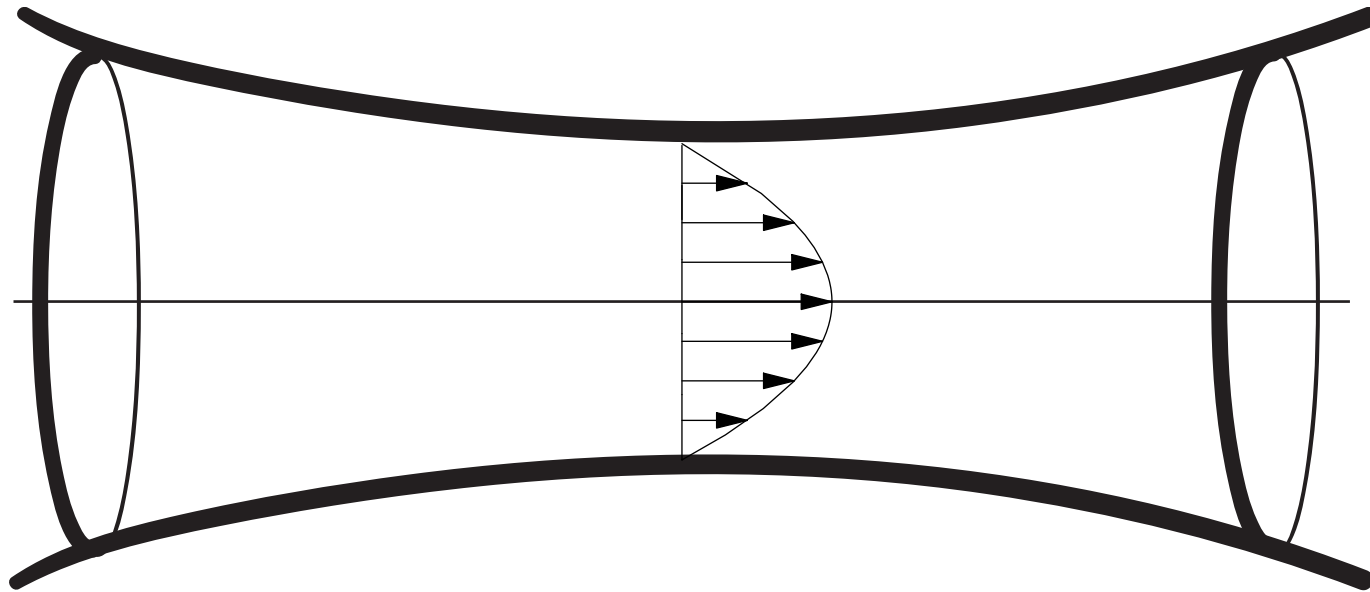

$$\frac{u^* - u^n}{\Delta t} + NL(u^n) = -\frac{\partial p^{\text{given}}}{\partial x} + \frac{\partial}{r \partial r} r \frac{\partial u^*}{\partial r}$$

$$p^{\text{given}} \rightarrow u^* \quad rv^*(R) = - \int_0^R r \frac{\partial u^*}{\partial x} dr \Big| \begin{array}{l} \frac{\partial R}{\partial t} \\ 0? \end{array} ?$$

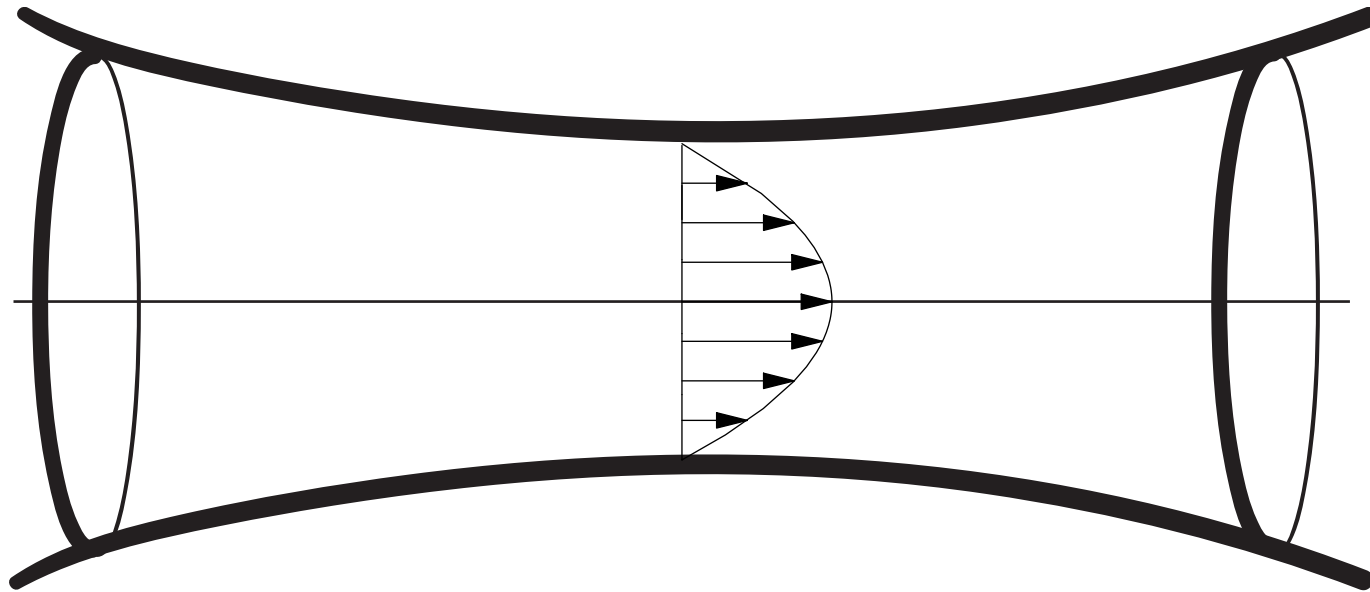

Newton on the pressure to obtain the boundary condition

$$\frac{u^* - u^n}{\Delta t} + NL(u^n) = -\frac{\partial p^{given}}{\partial x} + \frac{\partial}{\partial r} r \frac{\partial u^*}{\partial r}$$

$$p^{given} \rightarrow u^* \longrightarrow rv^*(R) = - \int_0^R r \frac{\partial u^*}{\partial x} dr \Big|_{\frac{\partial R}{\partial t} = 0?} ?$$

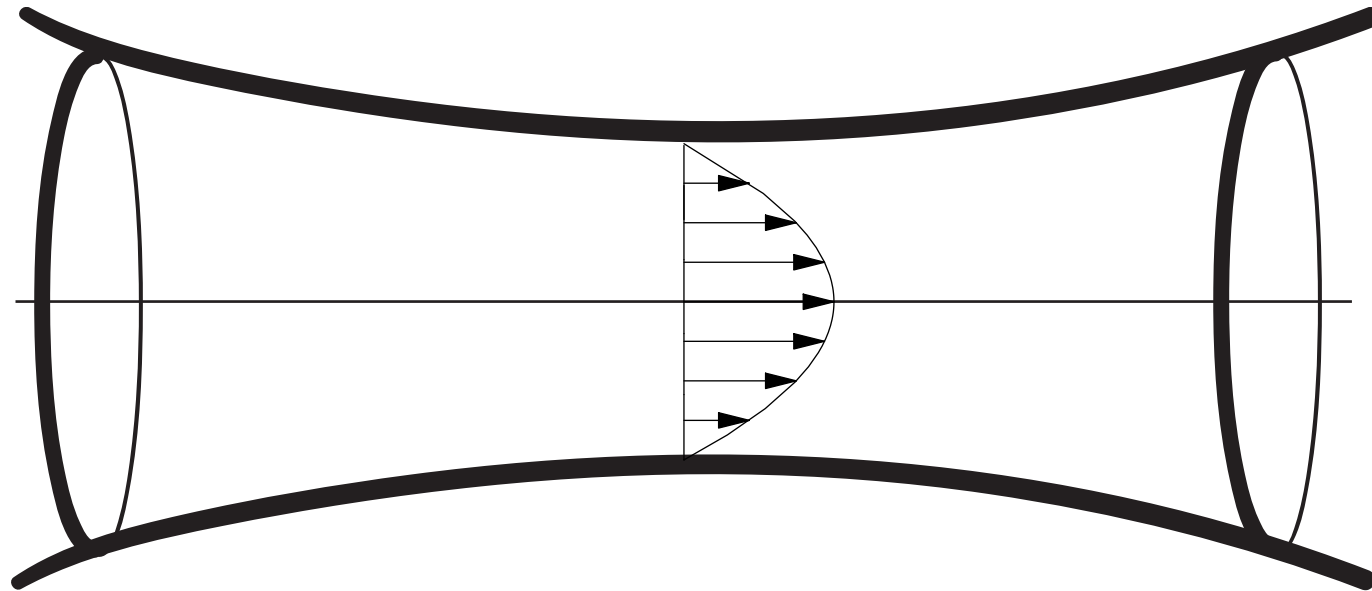

Pressure is a result of the computation

Integral resolution

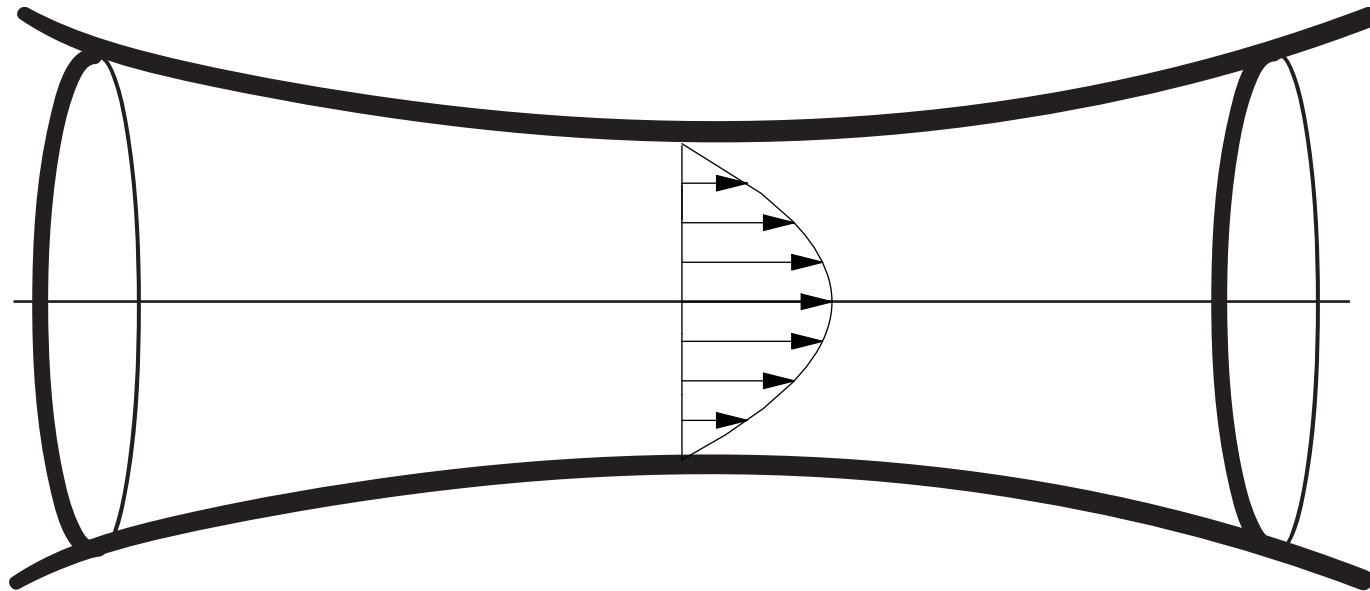

Integral resolution

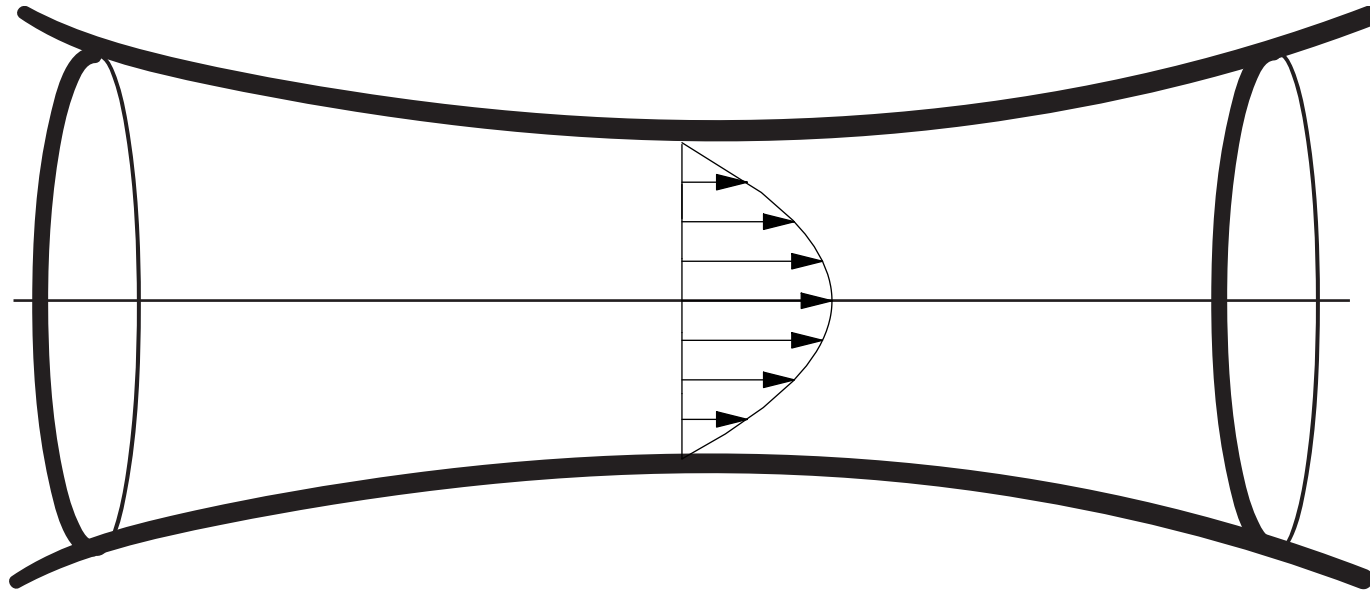

- integral system (ID) is included in RNSP
- we compute a more real profile

Integral resolution

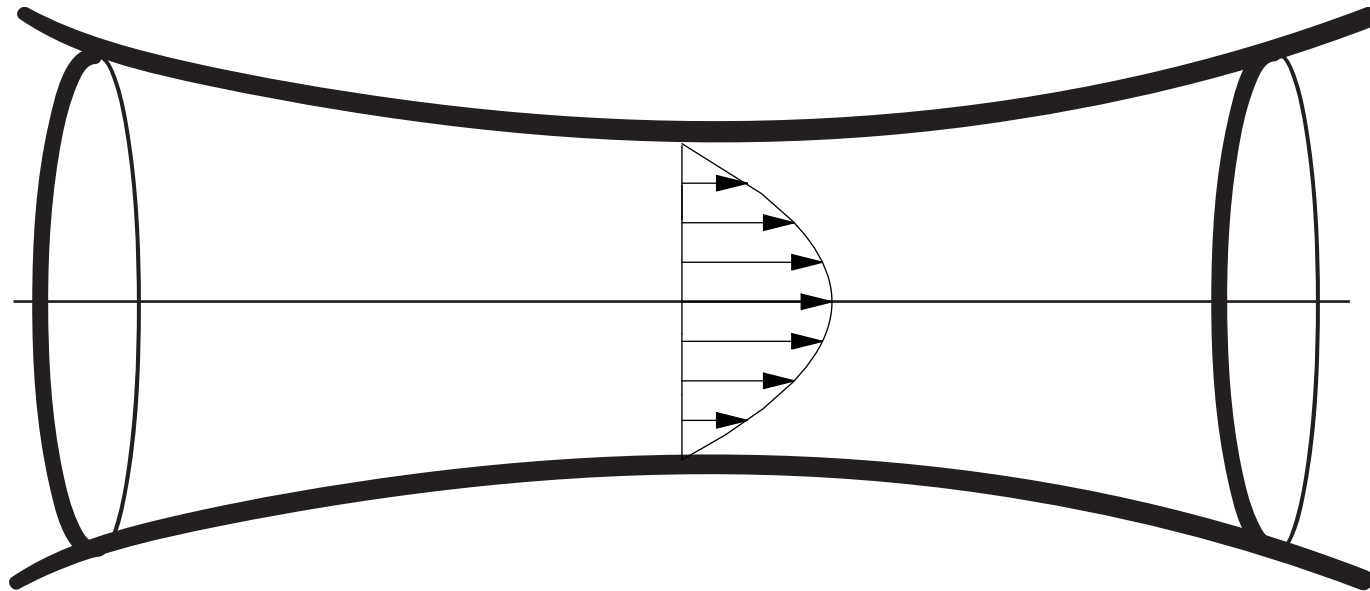

Integral resolution

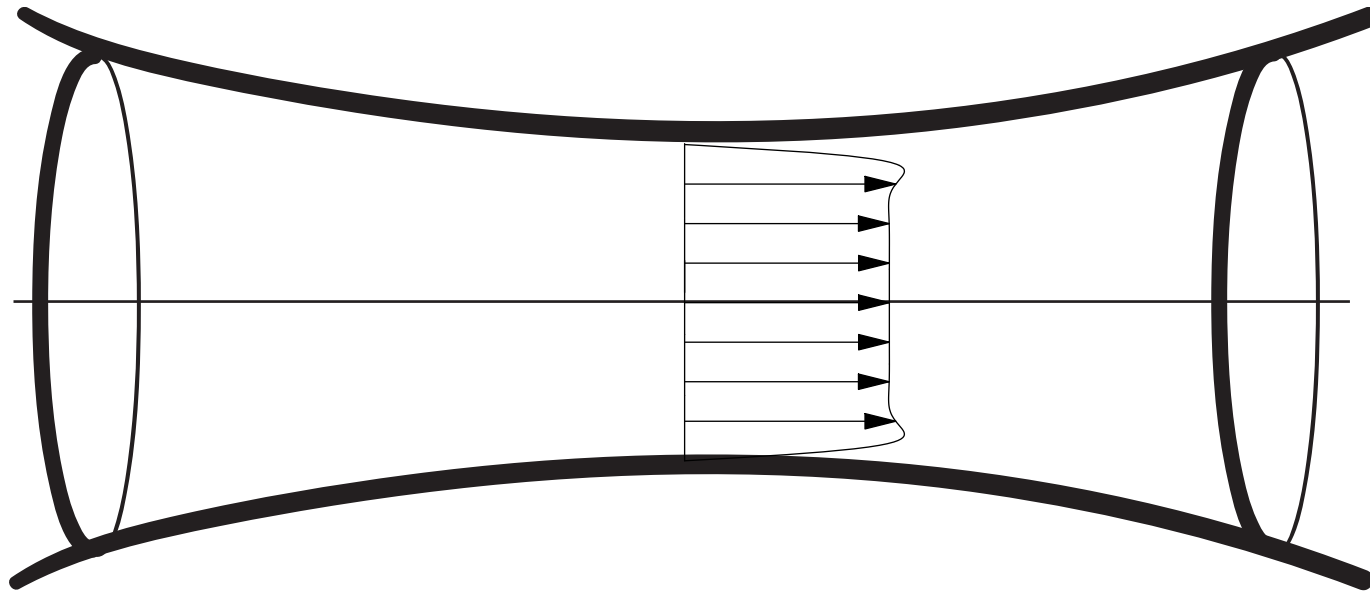

Integral resolution

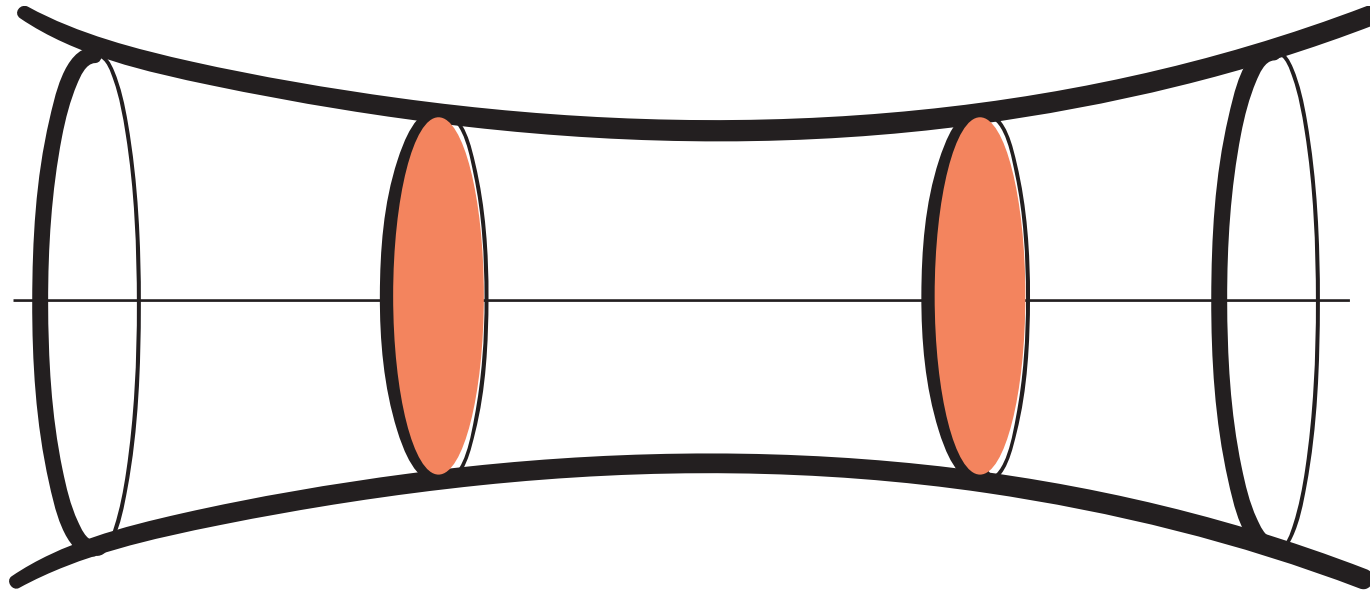

$$Q = \int_0^R 2\pi r u dr$$

Integral resolution

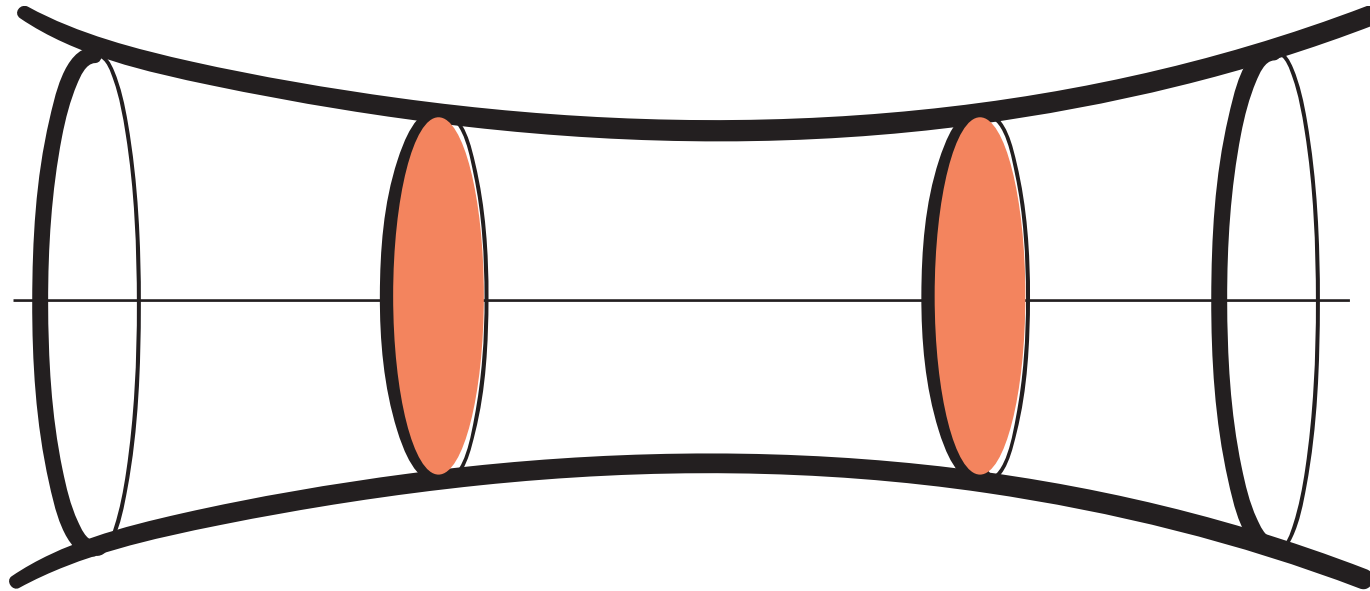

$$Q = \int_0^R 2\pi r u dr$$

$$\frac{\partial u}{\partial x} + \frac{\partial r v}{r \partial r} = 0$$

Integral resolution

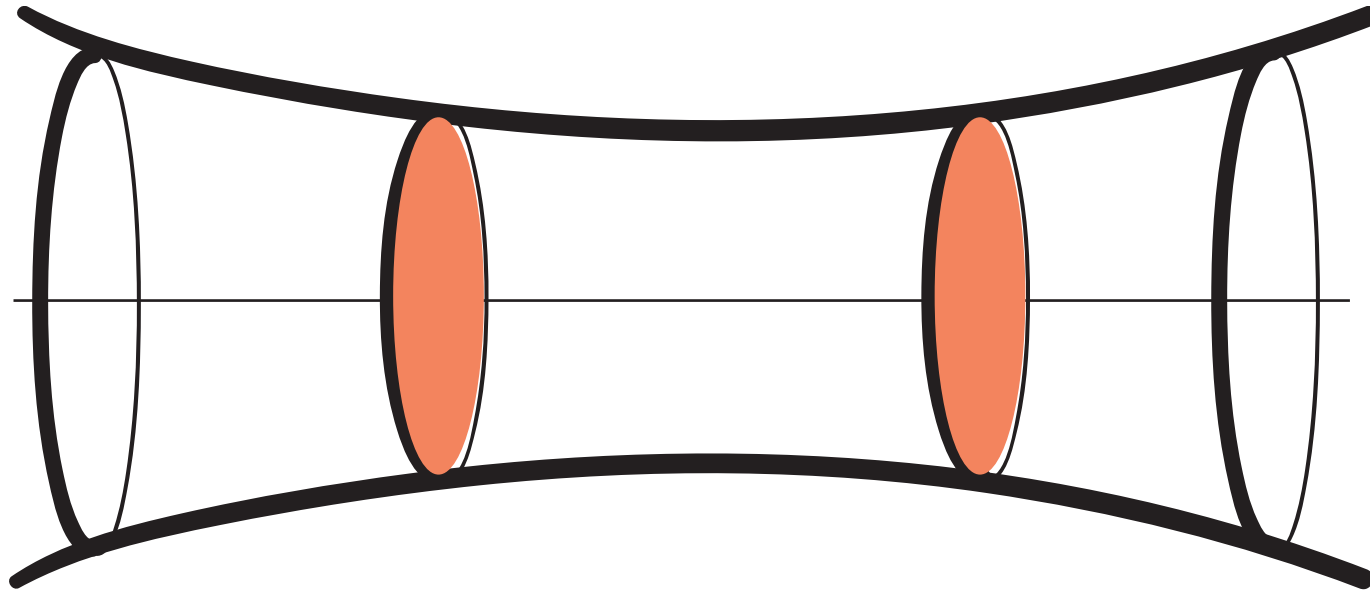

$$Q = \int_0^R 2\pi r u dr$$

$$\int_0^R 2\pi r dr \cdot \left(\frac{\partial u}{\partial x} + \frac{\partial r v}{r \partial r} \right) = 0$$

Integral resolution

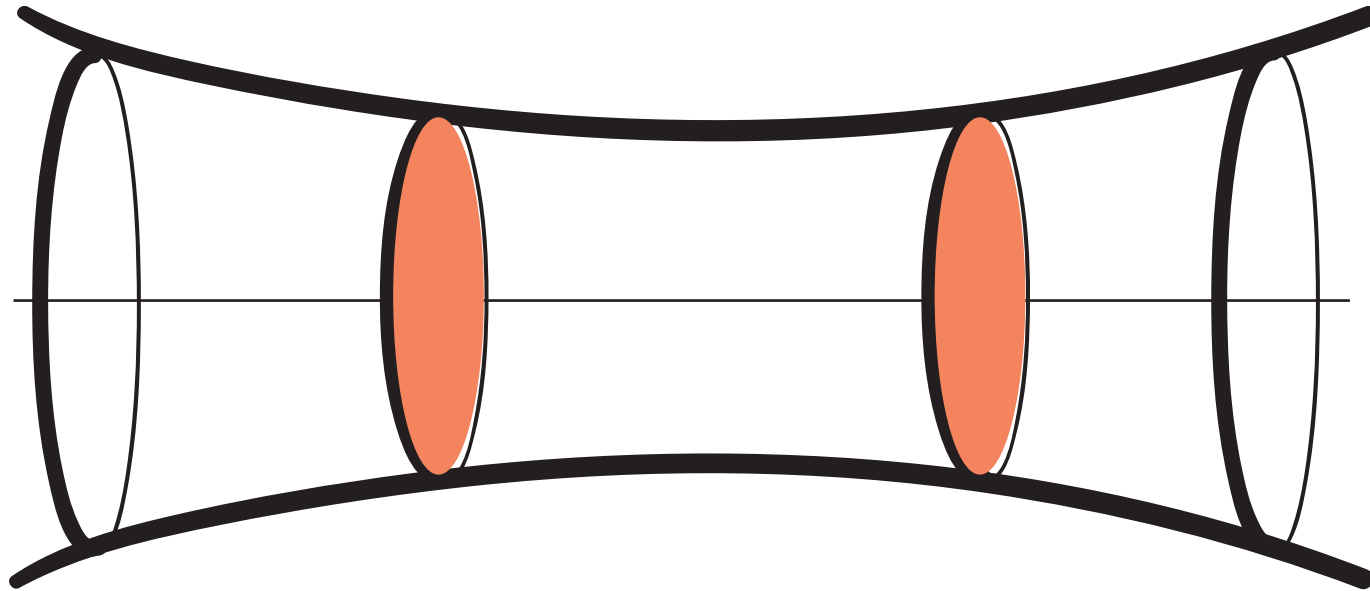

$$Q = \int_0^R 2\pi r u dr$$

$$\int_0^R 2\pi r dr \cdot \left(\frac{\partial u}{\partial x} + \frac{\partial r v}{r \partial r} \right) = 0 \rightarrow \frac{\partial(2\pi R^2)}{\partial t} + \frac{\partial Q}{\partial x} = 0$$

Integral resolution

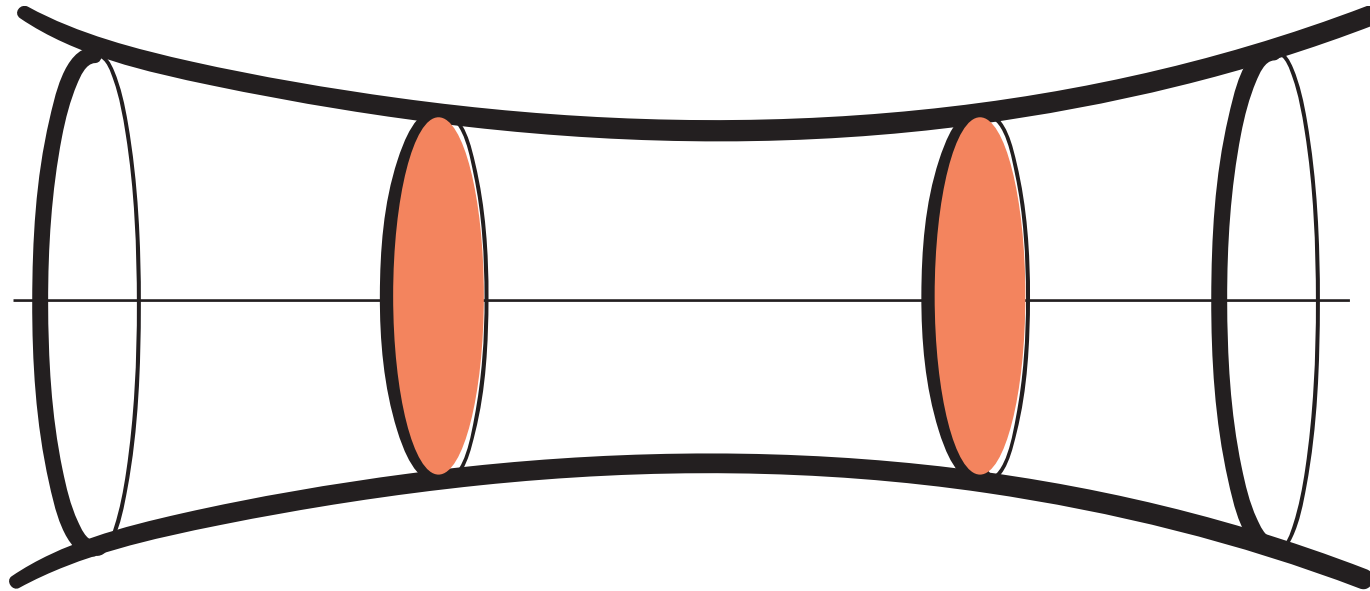

$$Q = \int_0^R 2\pi r u dr$$

$$\frac{\partial(2\pi R^2)}{\partial t} + \frac{\partial Q}{\partial x} = 0$$

Integral resolution

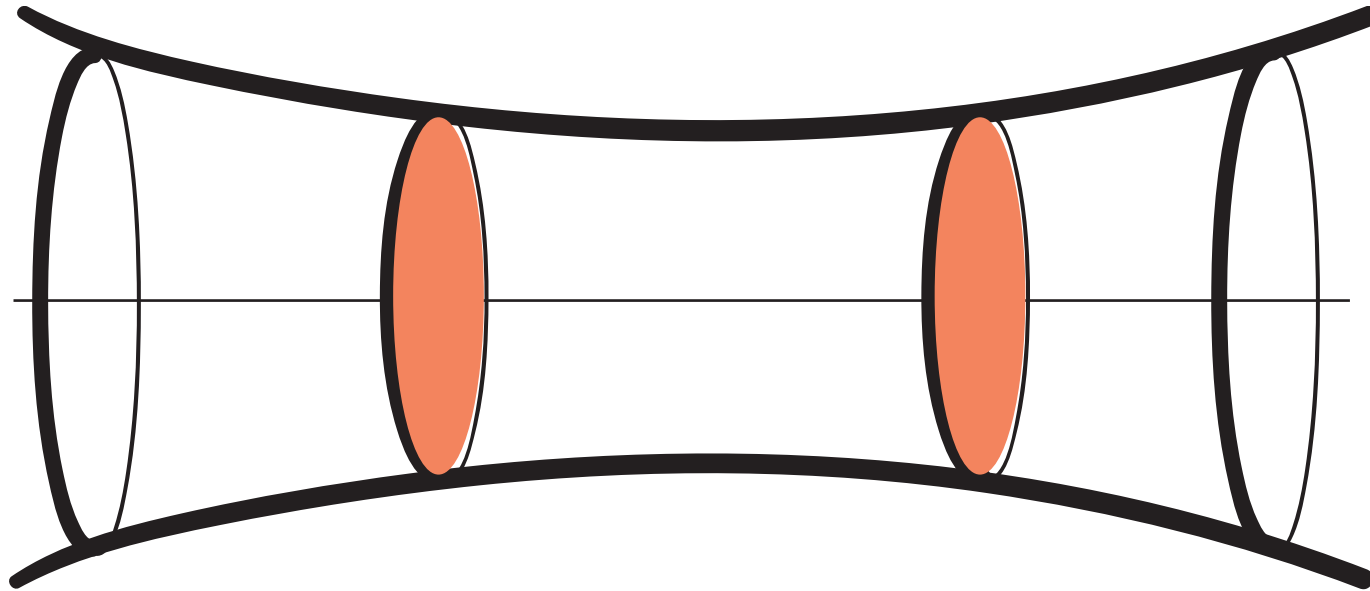

$$Q = \int_0^R 2\pi r u dr$$

$$\tau = \frac{\partial u}{\partial r}$$

Integral resolution

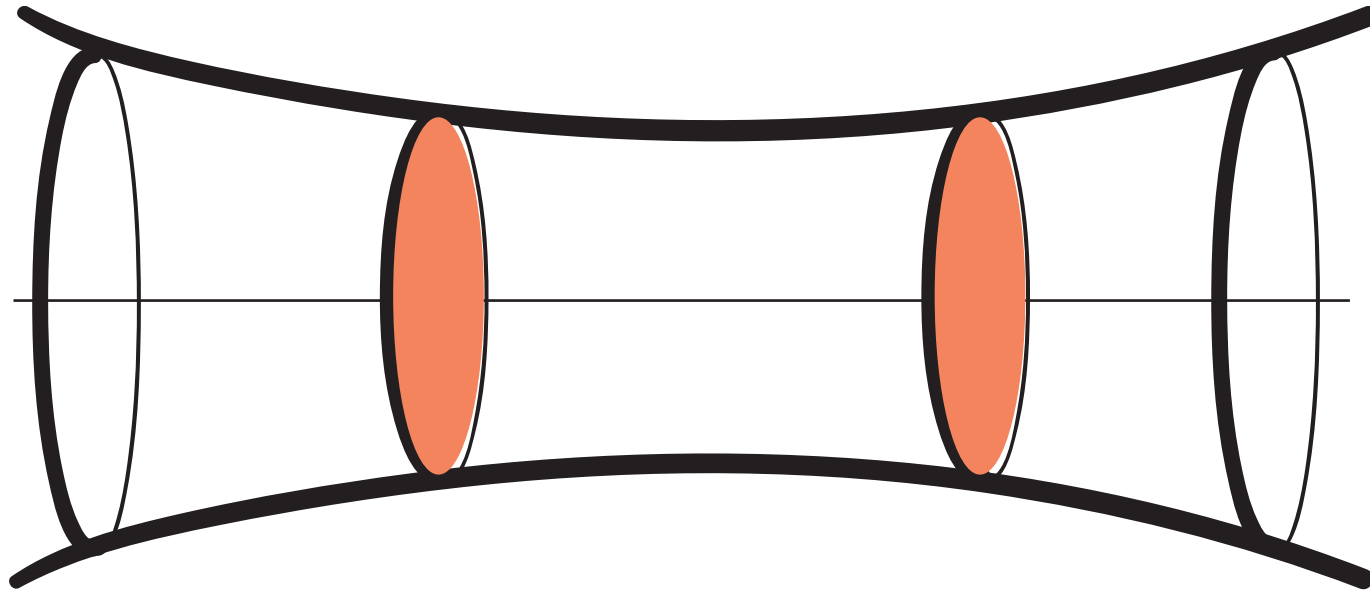

$$Q = \int_0^R 2\pi r u dr$$

$$Q_2 = \int_0^R 2\pi r u^2 dr$$

$$\tau = \frac{\partial u}{\partial r}$$

$$\int \left(\frac{\partial u}{\partial t} + u \frac{\partial}{\partial x} u + v \frac{\partial}{\partial r} u = -\frac{\partial p}{\rho \partial x} + v \frac{\partial}{r \partial r} r \frac{\partial u}{\partial r} \right)$$
$$0 = -\frac{\partial p}{\rho \partial r}$$

Integral resolution

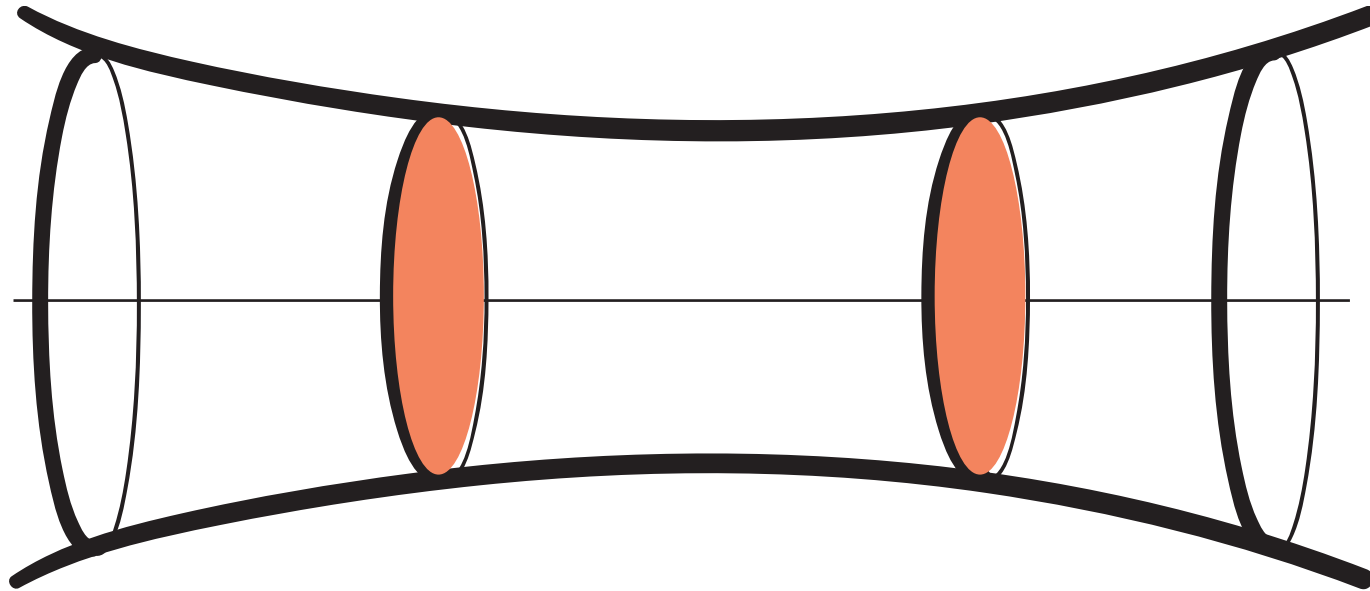

$$Q = \int_0^R 2\pi r u dr$$

$$Q_2 = \int_0^R 2\pi r u^2 dr$$

$$\tau = \frac{\partial u}{\partial r}$$

$$\frac{\partial Q}{\partial t} + \frac{\partial Q_2}{\partial t} = - (2\pi R^2) \frac{\partial p}{\partial x} - \tau$$

Integral resolution 1D equations

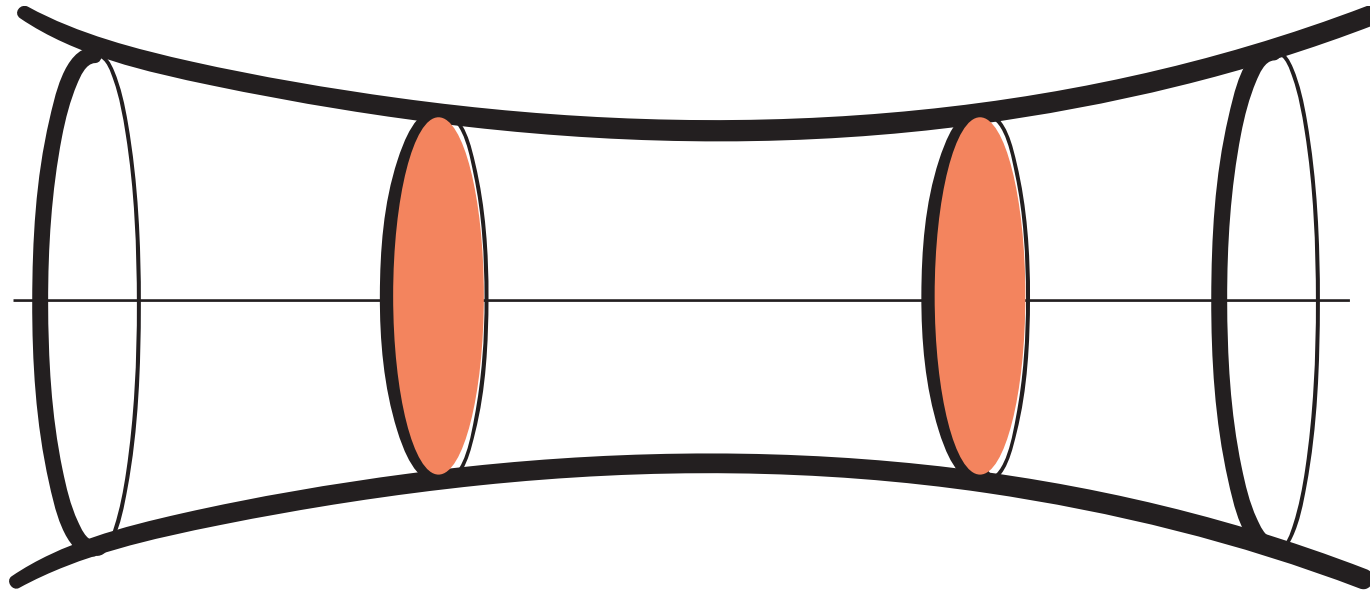

$$Q = \int_0^R 2\pi r u dr$$

$$Q_2 = \int_0^R 2\pi r u^2 dr$$

$$\tau = \frac{\partial u}{\partial r}$$

$$\frac{\partial(2\pi R^2)}{\partial t} + \frac{\partial Q}{\partial x} = 0$$

$$\frac{\partial Q}{\partial t} + \frac{\partial Q_2}{\partial t} = -(2\pi R^2) \frac{\partial p}{\partial x} - \tau$$

Integral resolution 1D equations

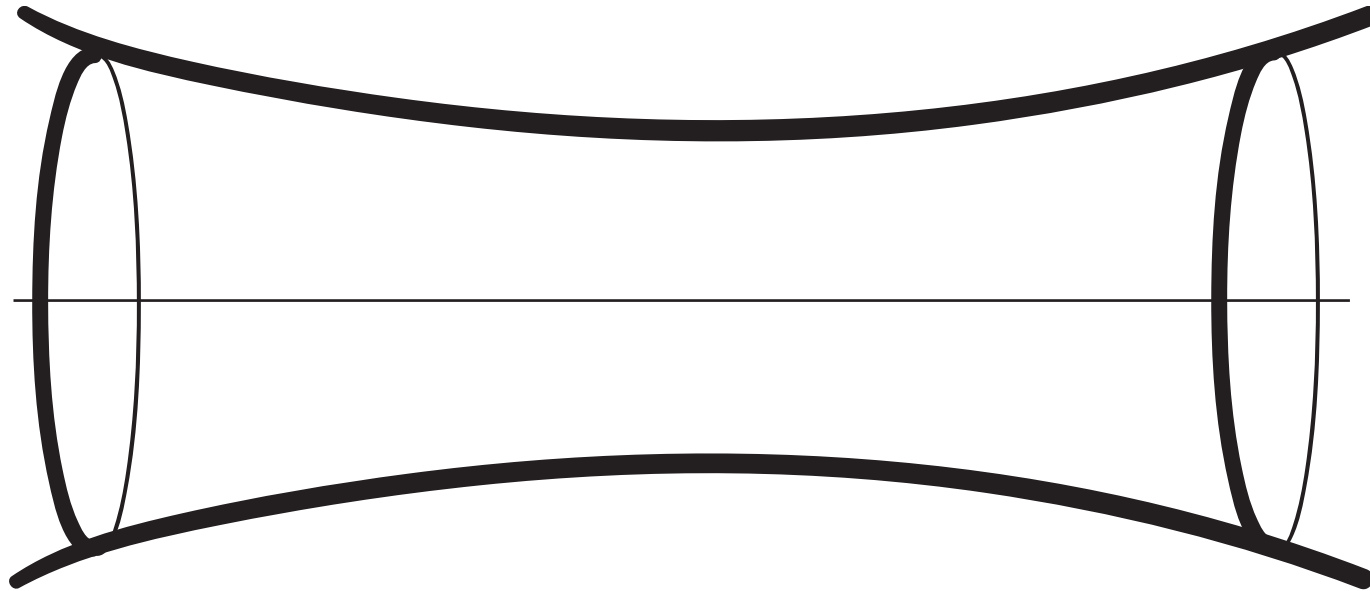

$$Q = \int_0^R 2\pi r u dr \quad Q_2 = \int_0^R 2\pi r u^2 dr \quad \tau = \frac{\partial u}{\partial r}$$

gives Q_2 as function of Q and τ as function Q

Integral resolution 1D equations

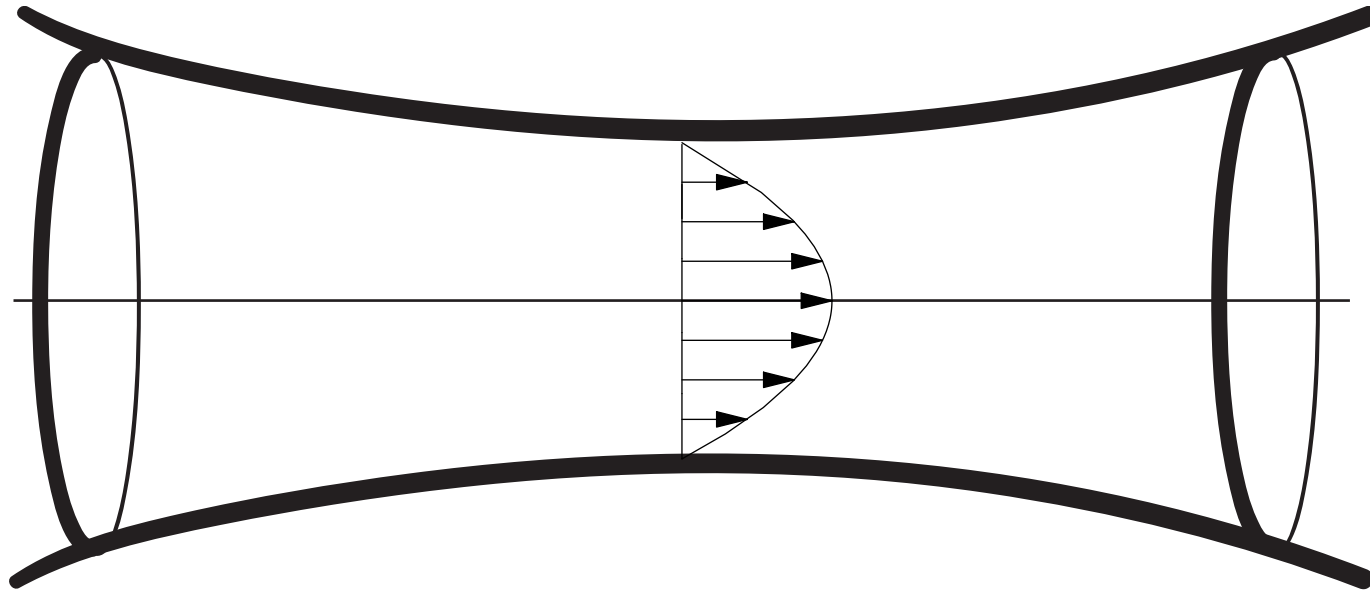

$$Q_2 = \int_0^R 2\pi r u^2 dr \quad \tau = \frac{\partial u}{\partial r}$$

Integral resolution 1D equations

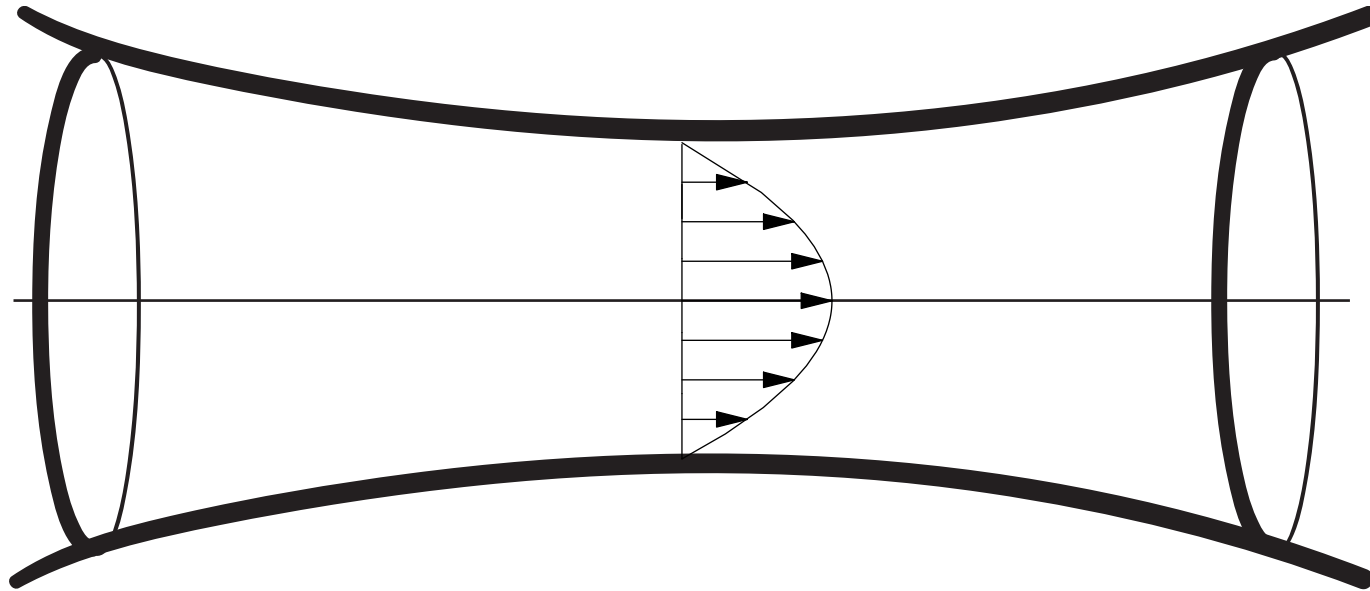

$$Q_2 = \int_0^R 2\pi r u^2 dr \quad \tau = \frac{\partial u}{\partial r}$$

$$Q_2 = \left(\frac{4}{3}\right) \frac{Q^2}{\pi R^2} \quad \tau = (8\pi) \frac{Q}{\pi R^2}$$

Integral resolution 1D equations

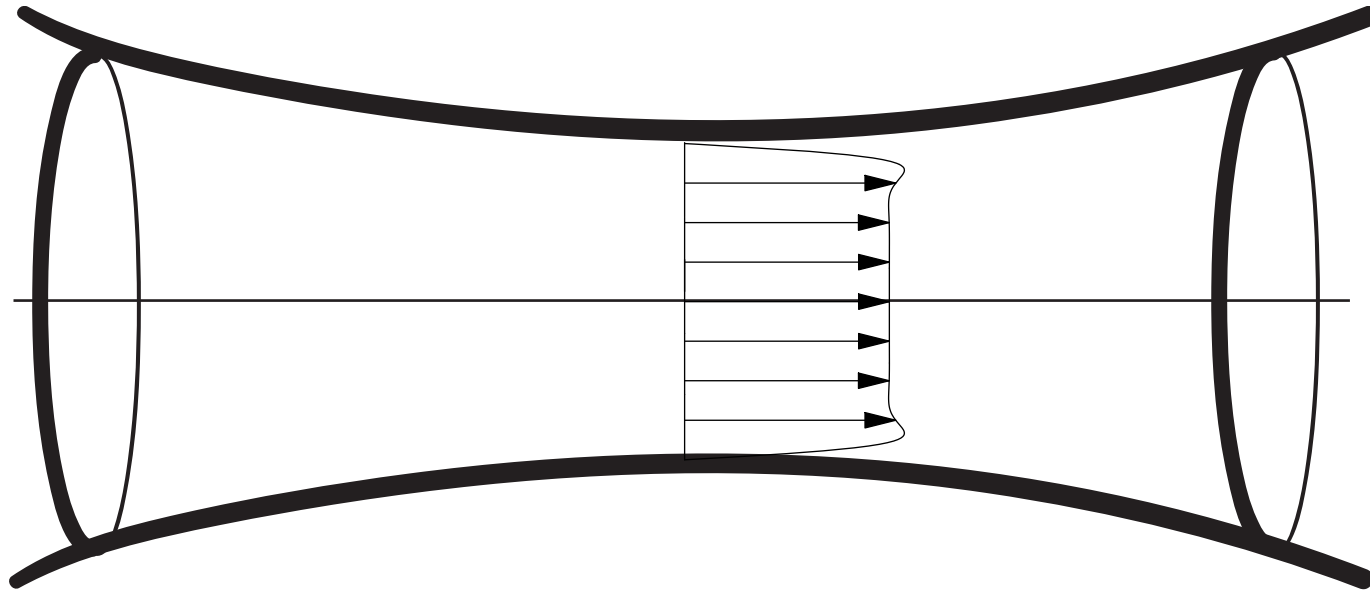

$$Q_2 = \int_0^R 2\pi r u^2 dr \quad \tau = \frac{\partial u}{\partial r}$$

Integral resolution 1D equations

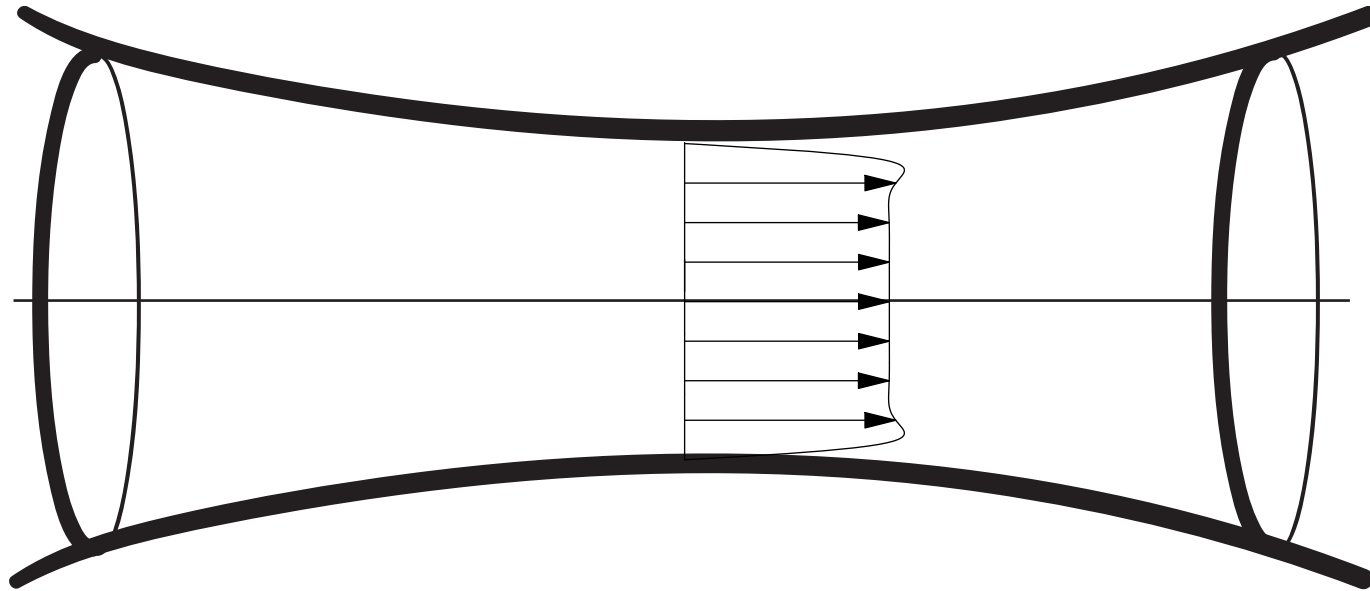

$$Q_2 = \int_0^R 2\pi r u^2 dr \quad \tau = \frac{\partial u}{\partial r}$$

$$Q_2 = \frac{Q^2}{\pi R^2} \quad \tau = F(Q)$$

Integral resolution ID equations

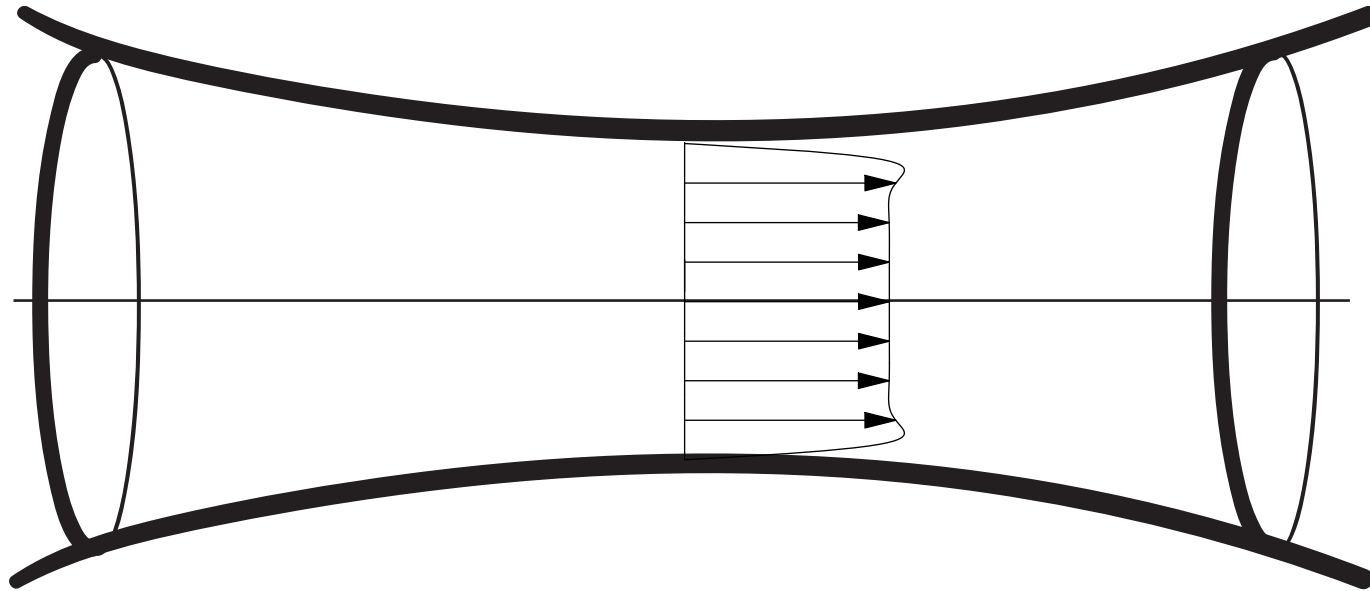

need of profile

Integral resolution ID equations

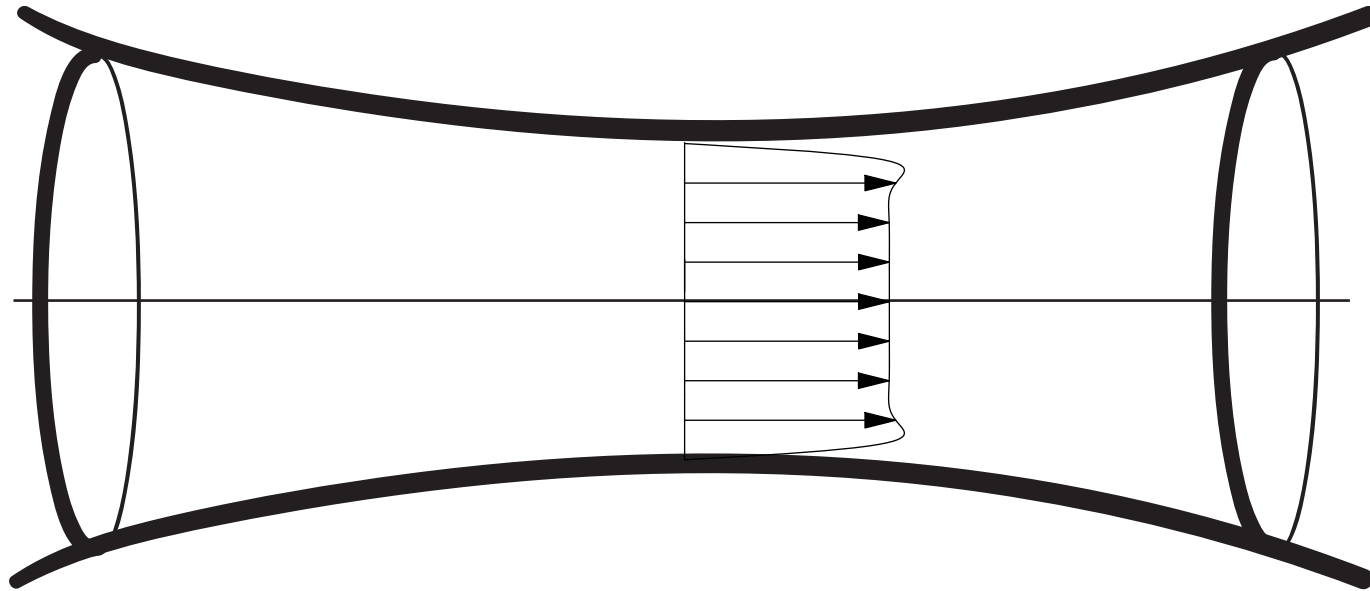

“usual” ID equations are a simplification of RNSP

Choice of profiles

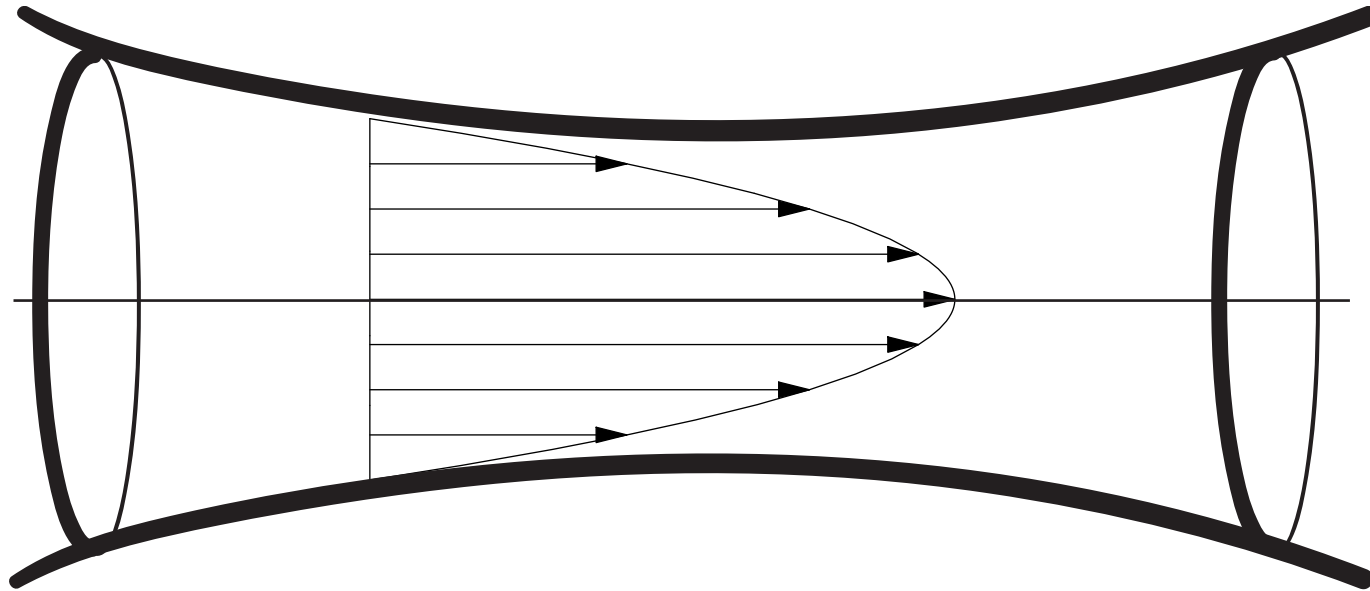

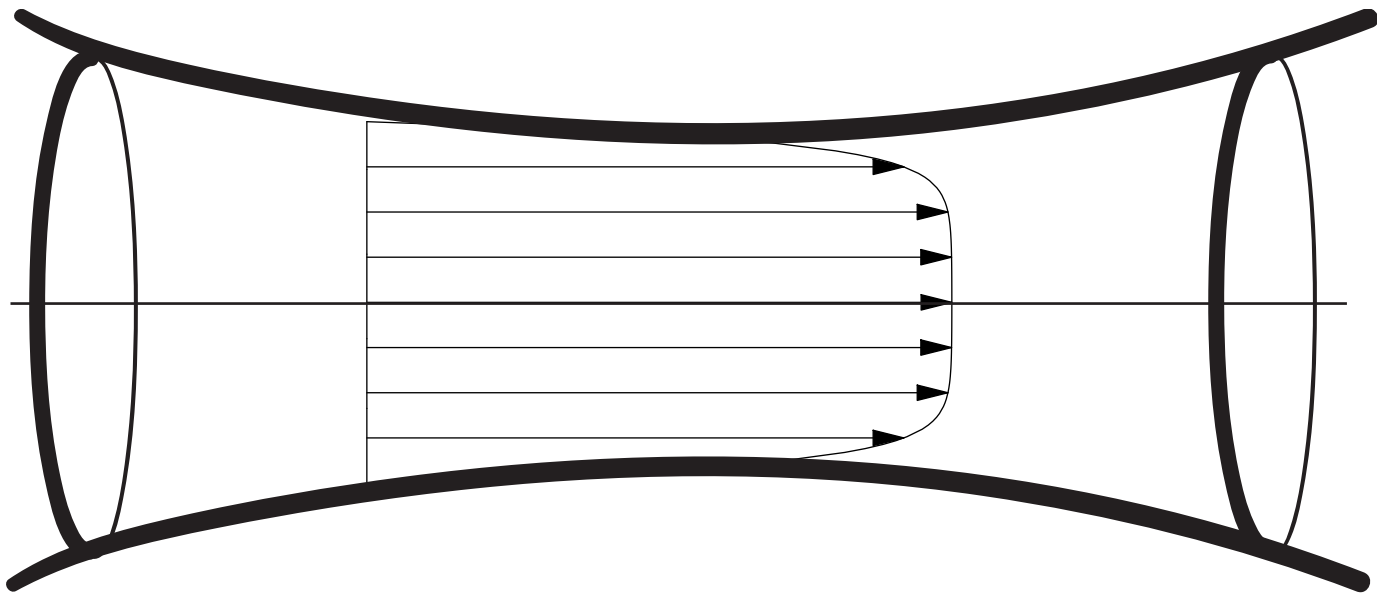

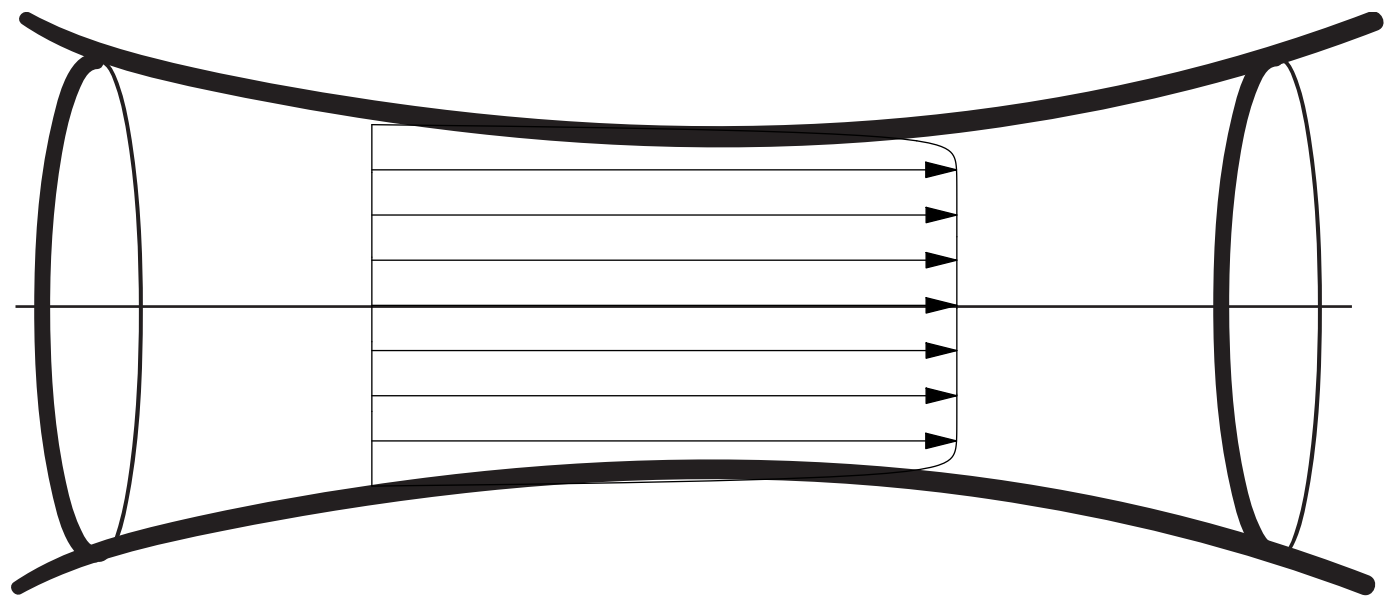

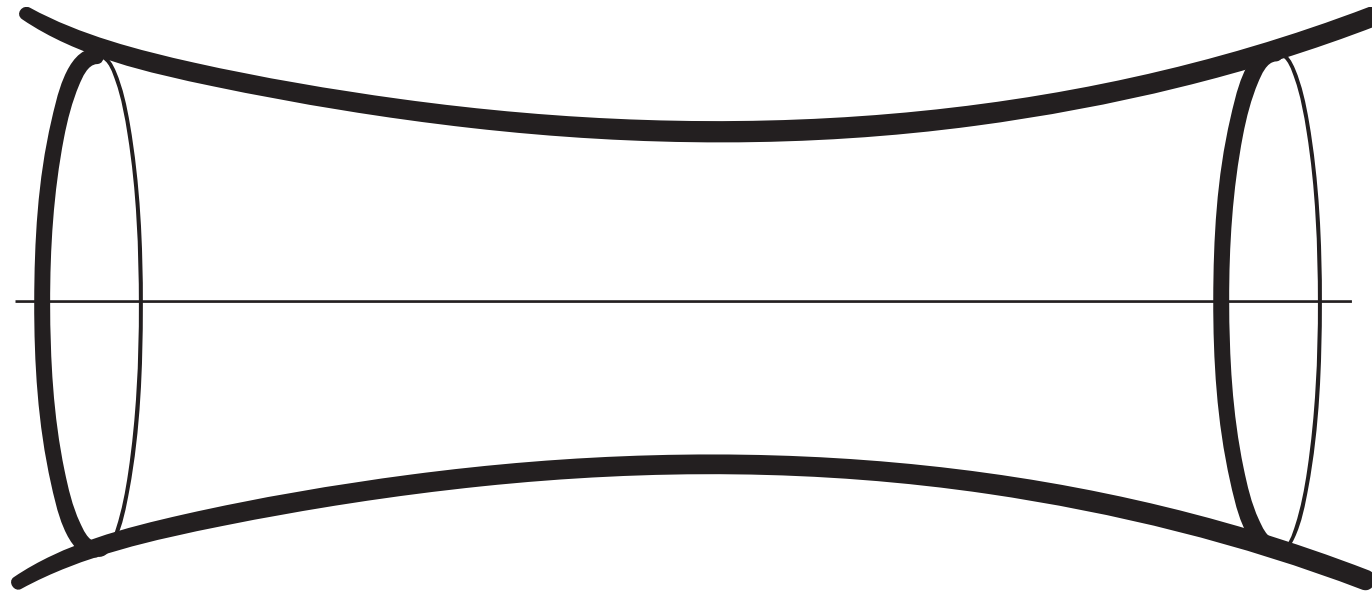

Choice of the family of simple profiles

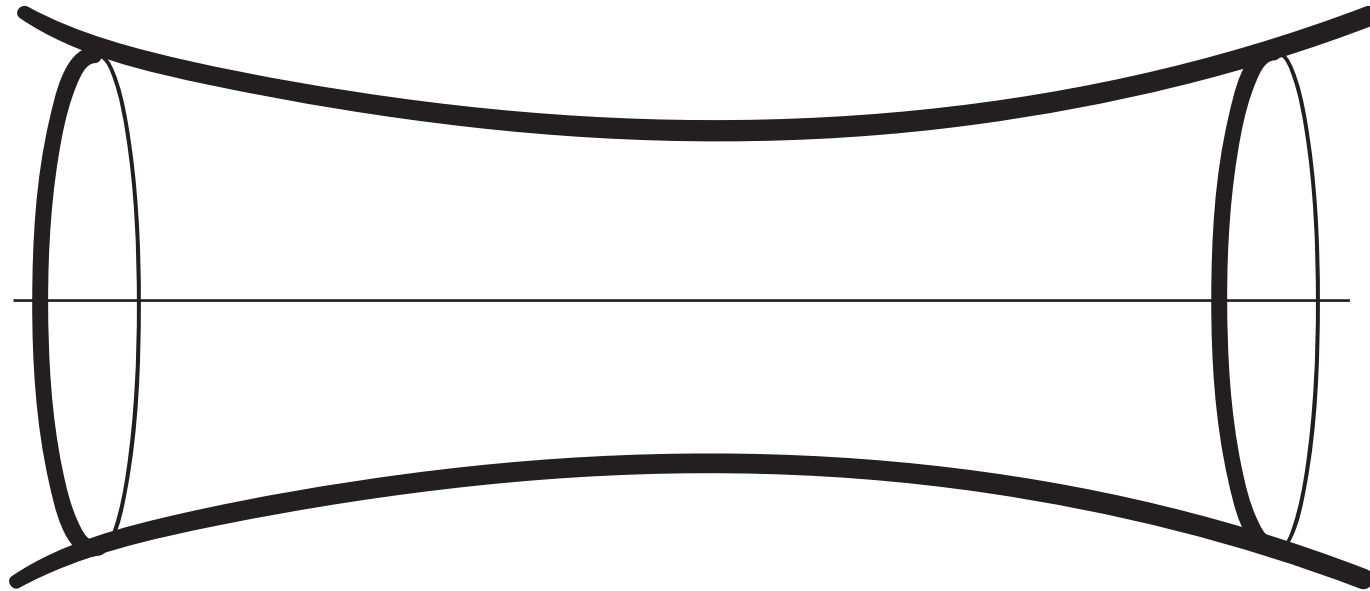

Choice of the family of simple profiles

In an unsteady flow it is natural to use Womersley

$$\frac{\partial u}{\partial t} + u \frac{\partial}{\partial x} u + v \frac{\partial}{\partial r} u = -\frac{\partial p}{\rho \partial x} + v \frac{\partial}{r \partial r} r \frac{\partial u}{\partial r}$$
$$0 = -\frac{\partial p}{\rho \partial r}$$

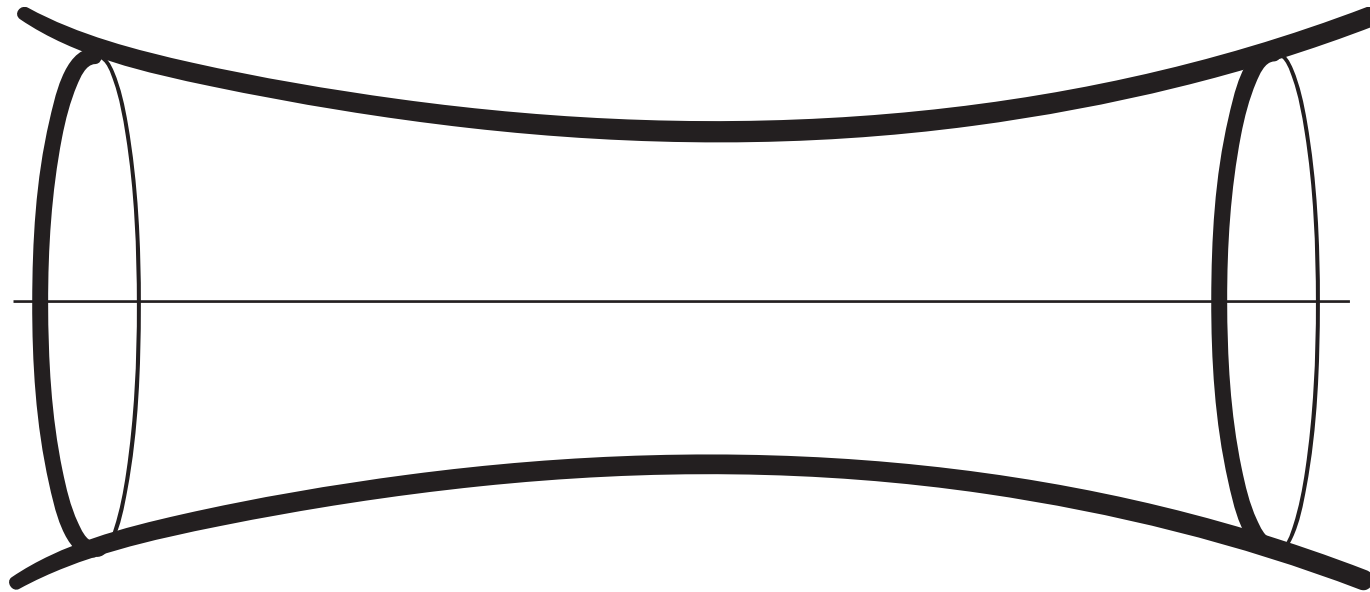

Choice of the family of simple profiles

In an unsteady flow it is natural to use Womersley

Womersley profiles are solution of RNSP

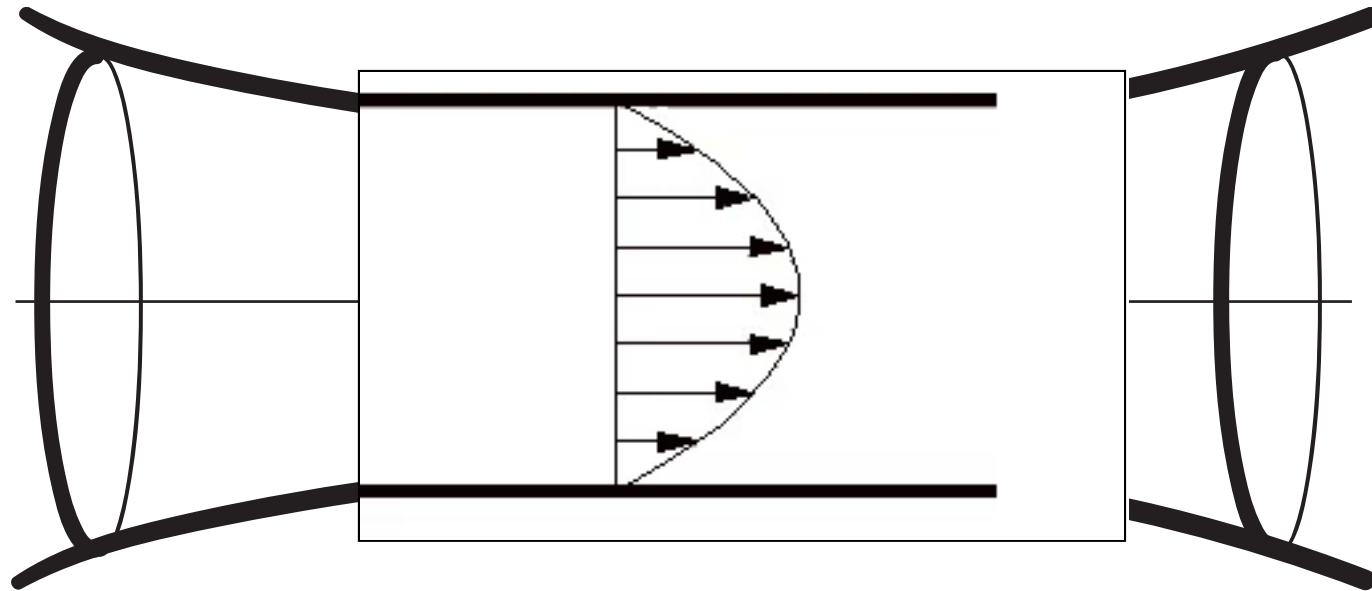

Choice of the family of simple profiles

In an unsteady flow it is natural to use Womersley

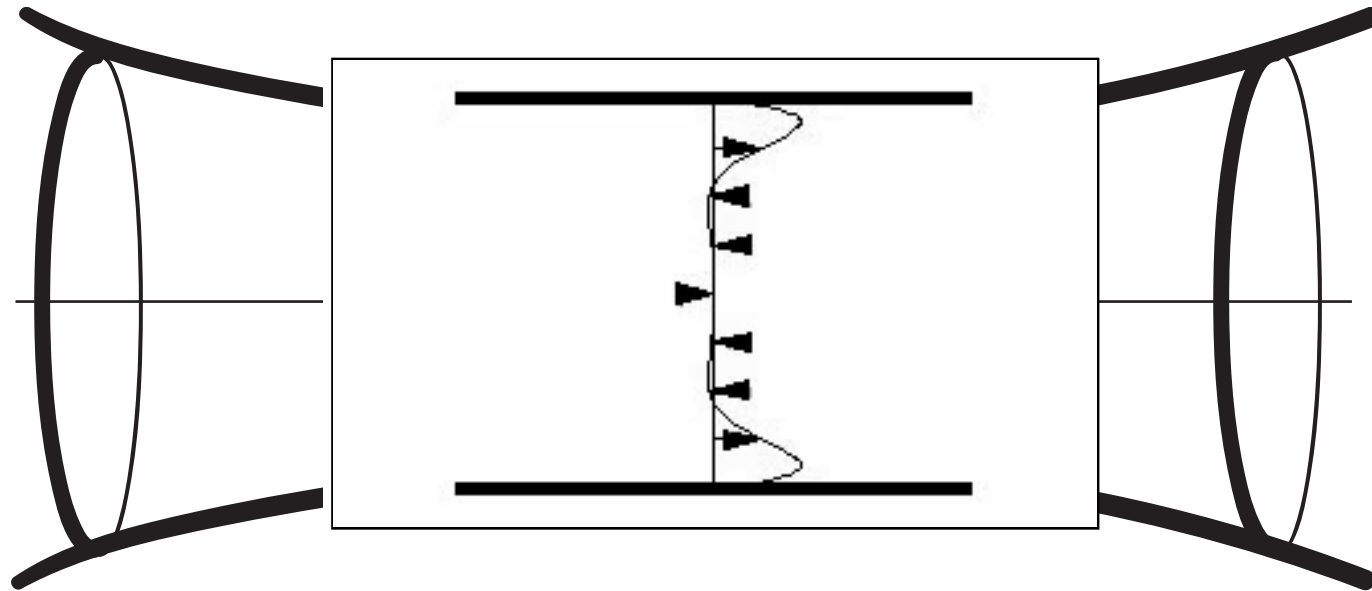

Choice of the family of simple profiles

In an unsteady flow it is natural to use Womersley

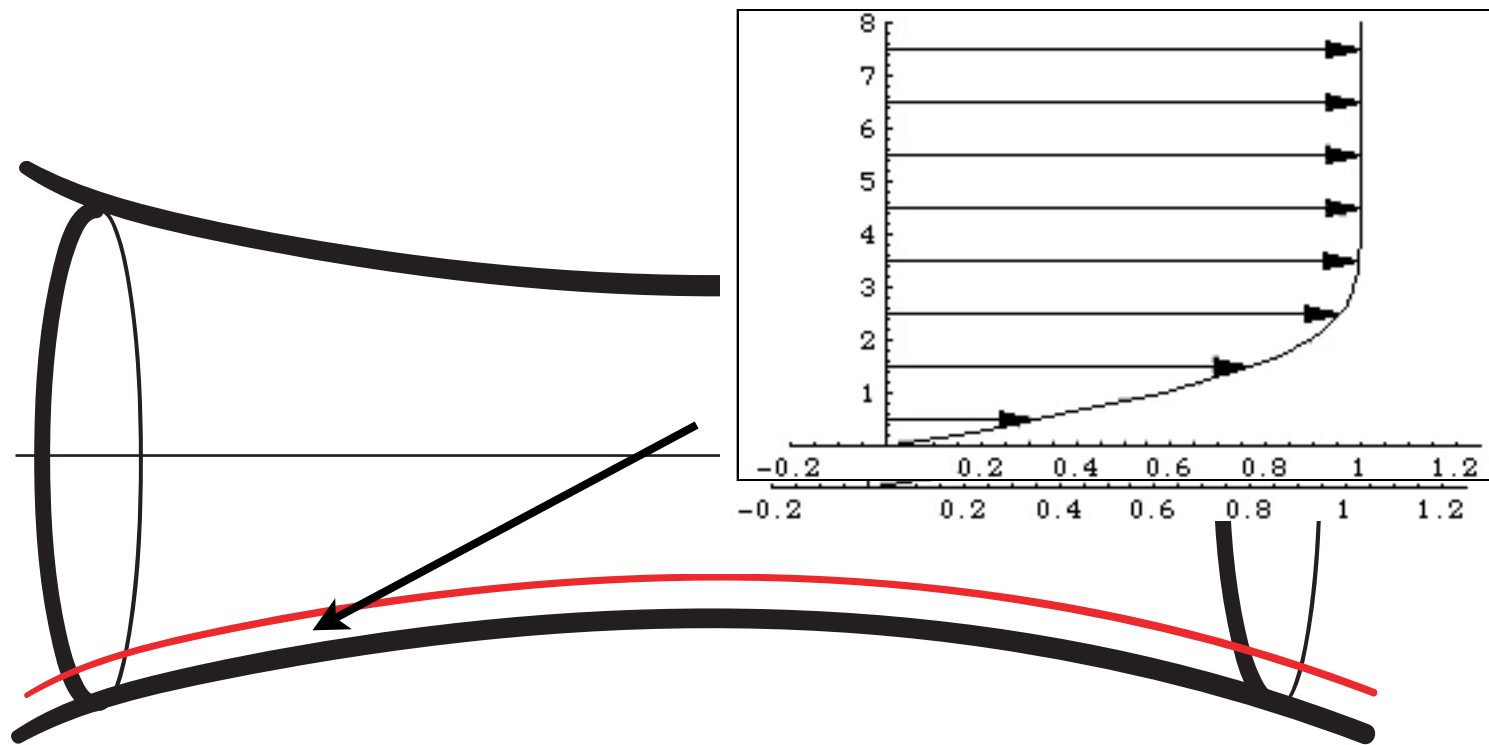

Choice of the family of simple profiles

In a steady flow it is natural to use Falkner Skan

Integral resolution

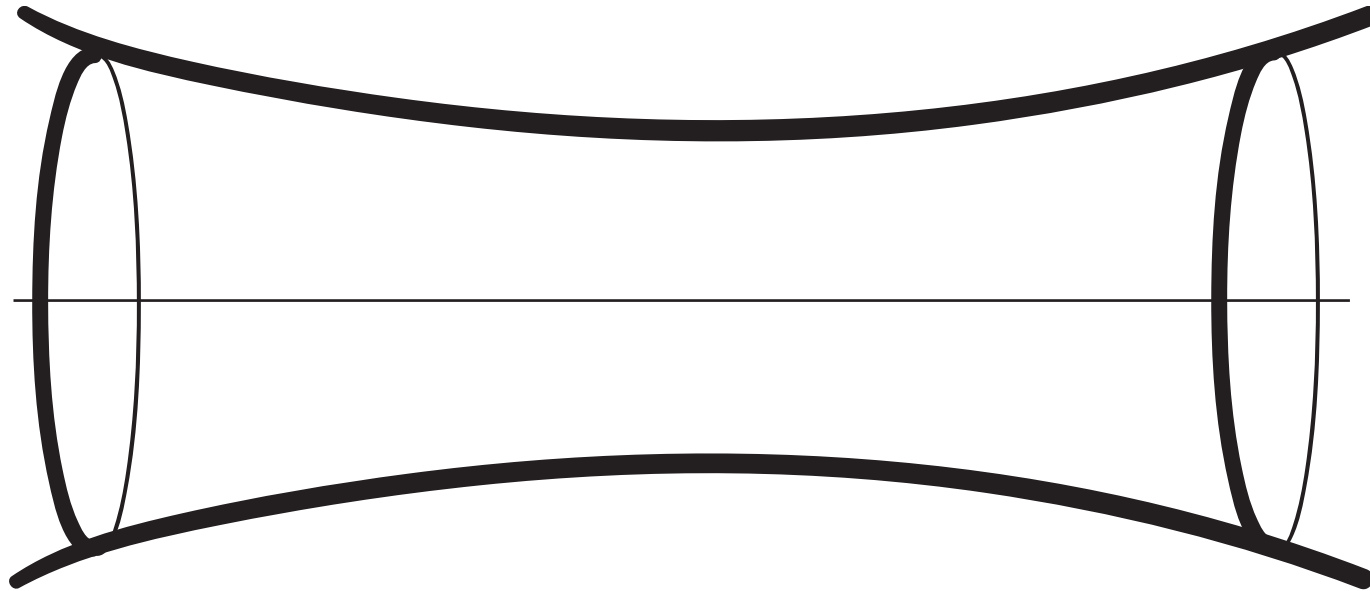

$$Q = \int_0^R 2\pi r u dr \quad Q_2 = \int_0^R 2\pi r u^2 dr \quad \tau = \frac{\partial u}{\partial r}$$

gives Q_2 as function of Q and τ as function Q

Integral resolution

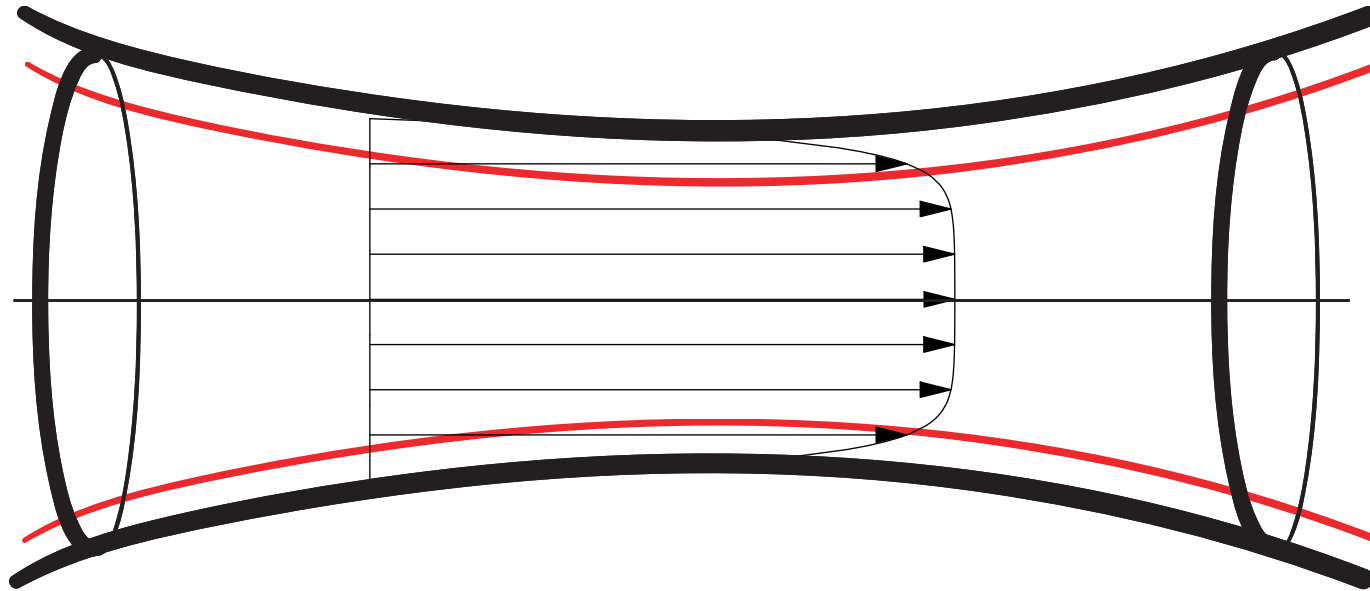

Numerical resolution:
finite differences

Interactive Boundary Layer

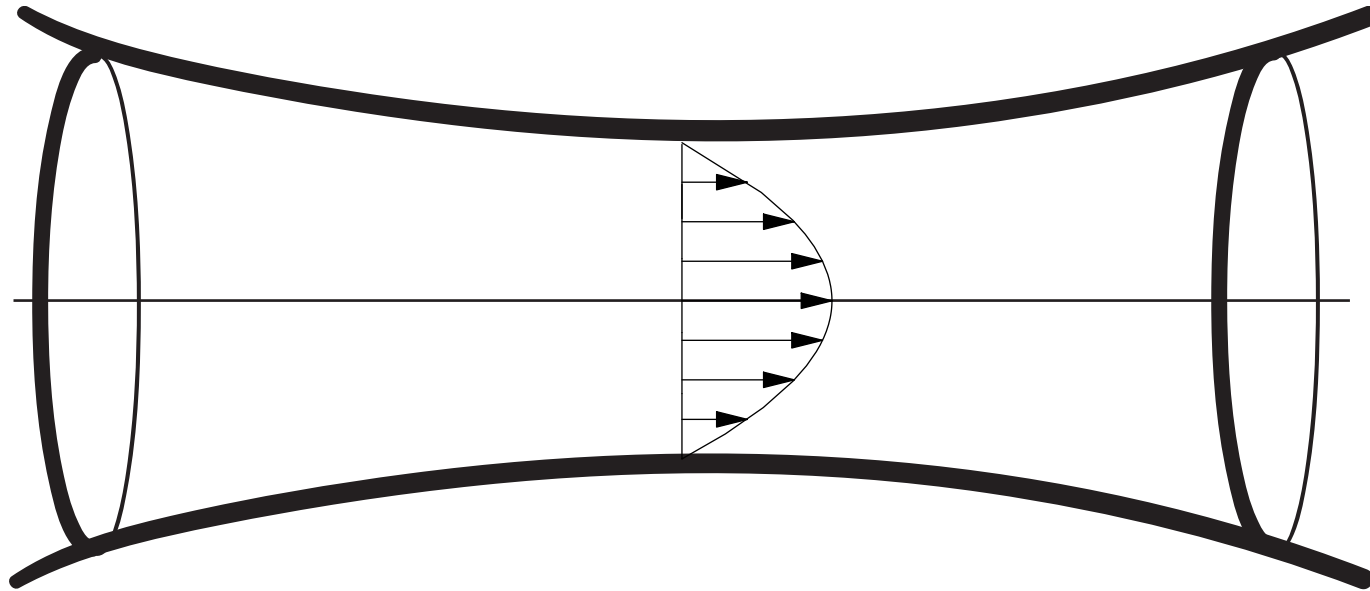

Interactive Boundary Layer

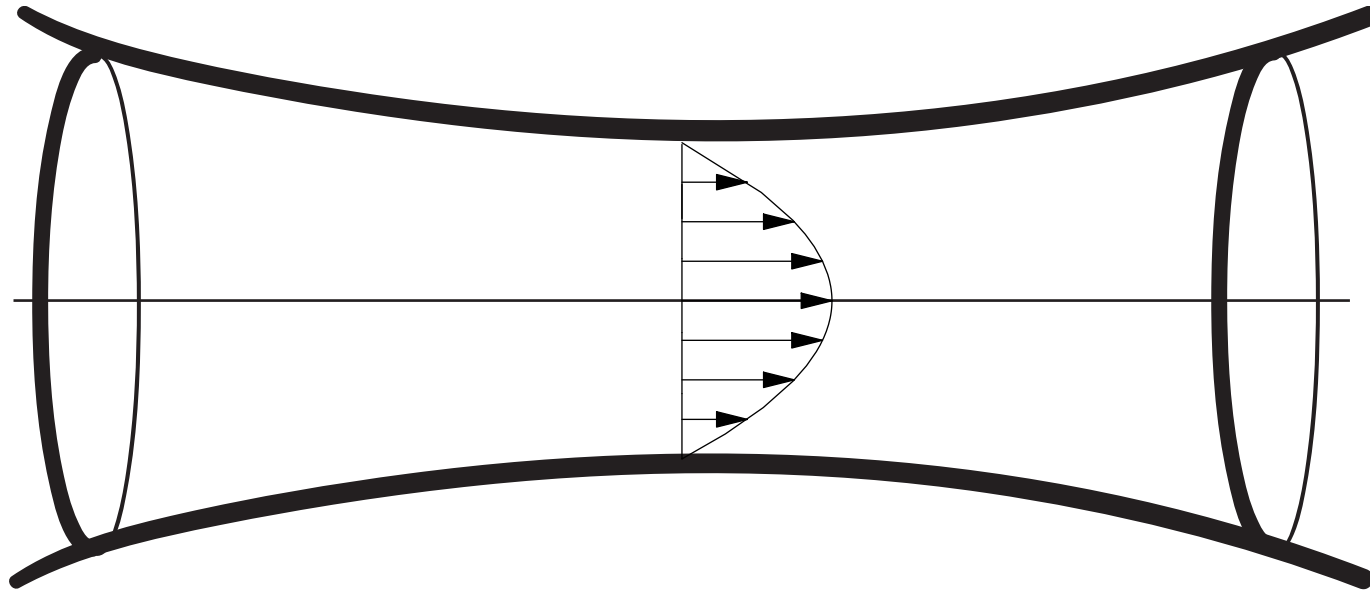

IBL is included in RNSP

Interactive Boundary Layer

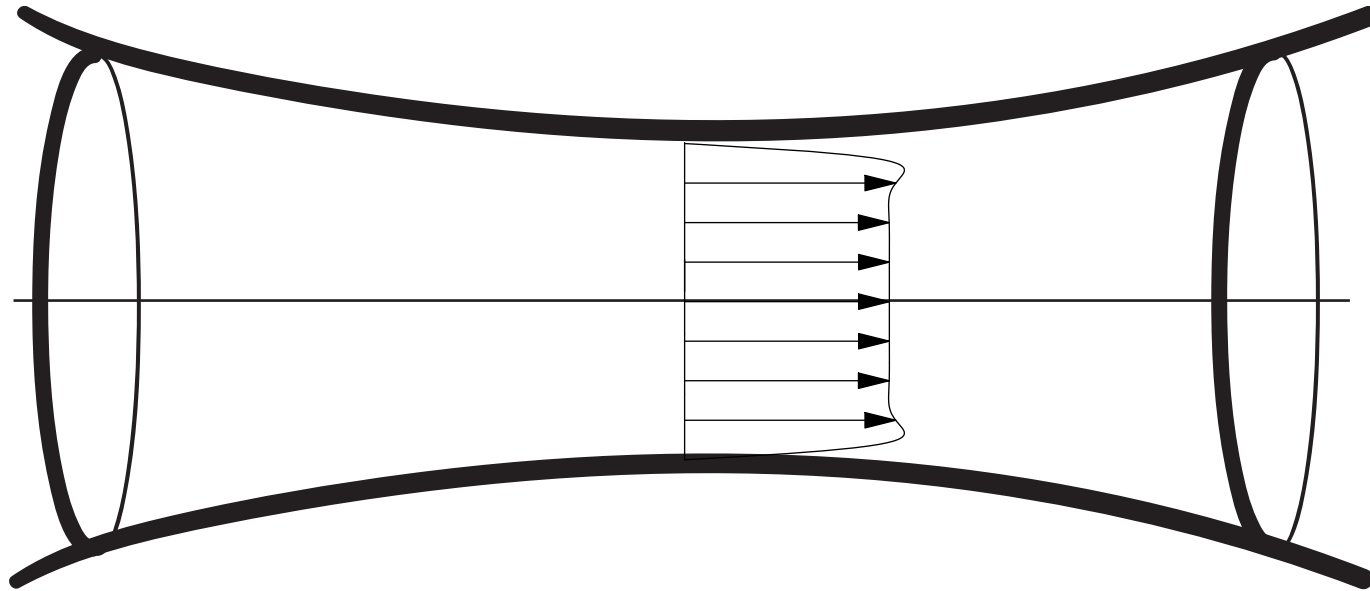

Interactive Boundary Layer

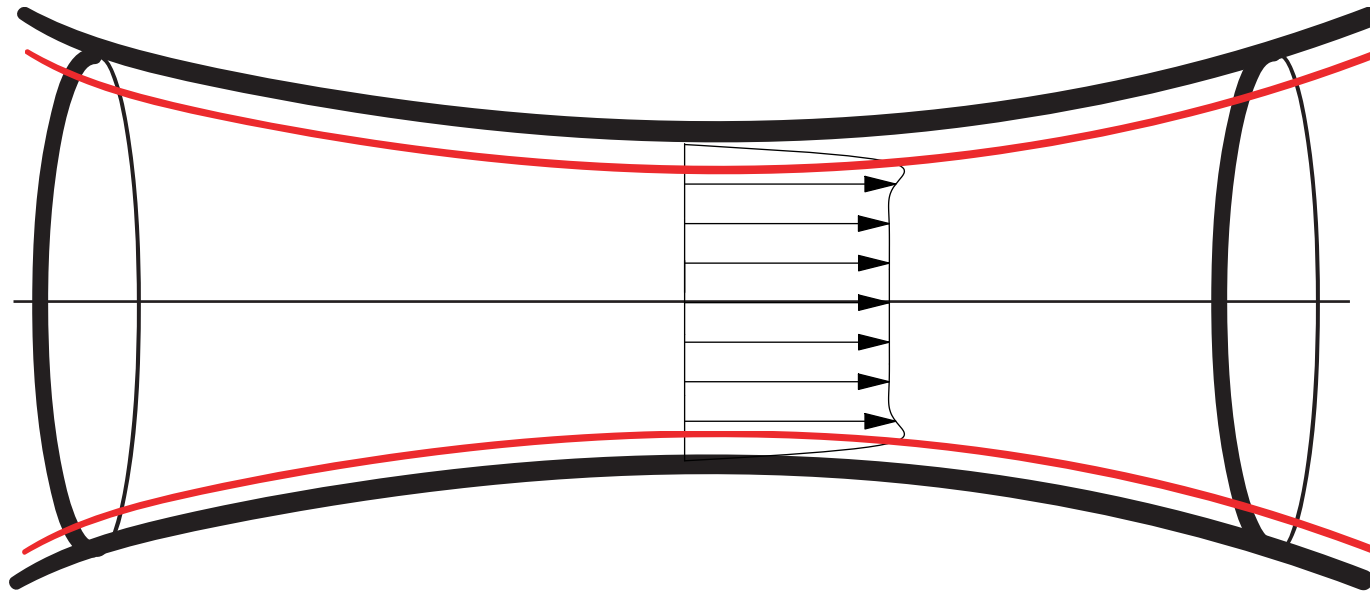

Interactive Boundary Layer

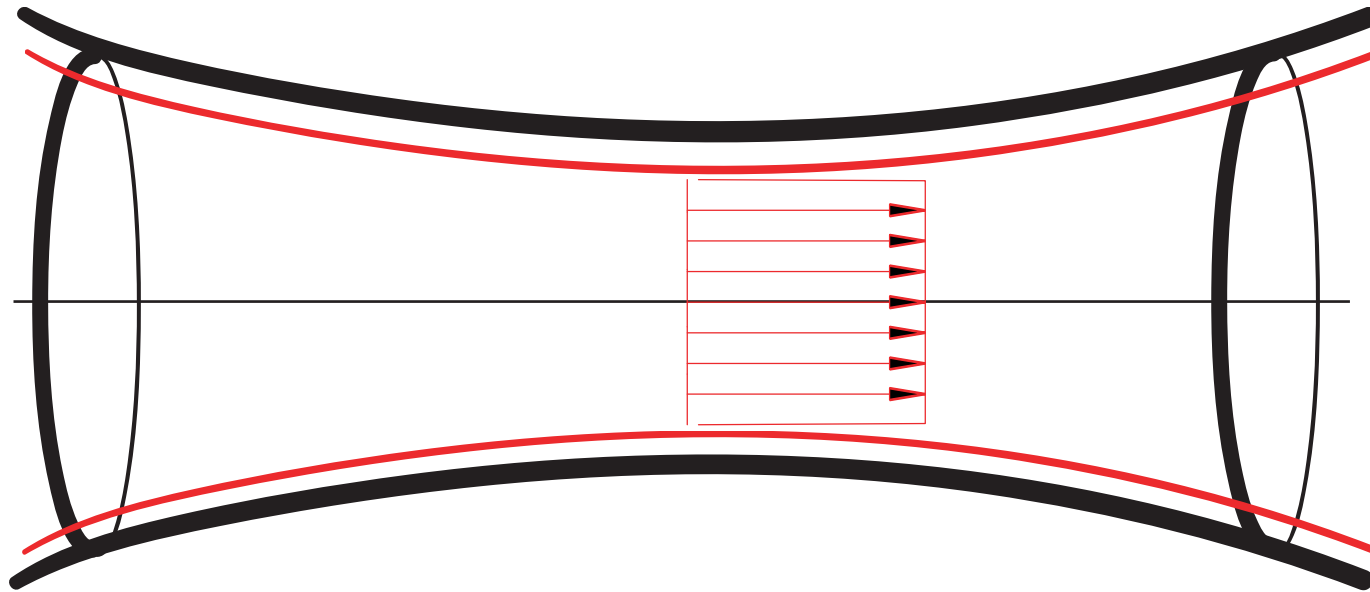

Interactive Boundary Layer

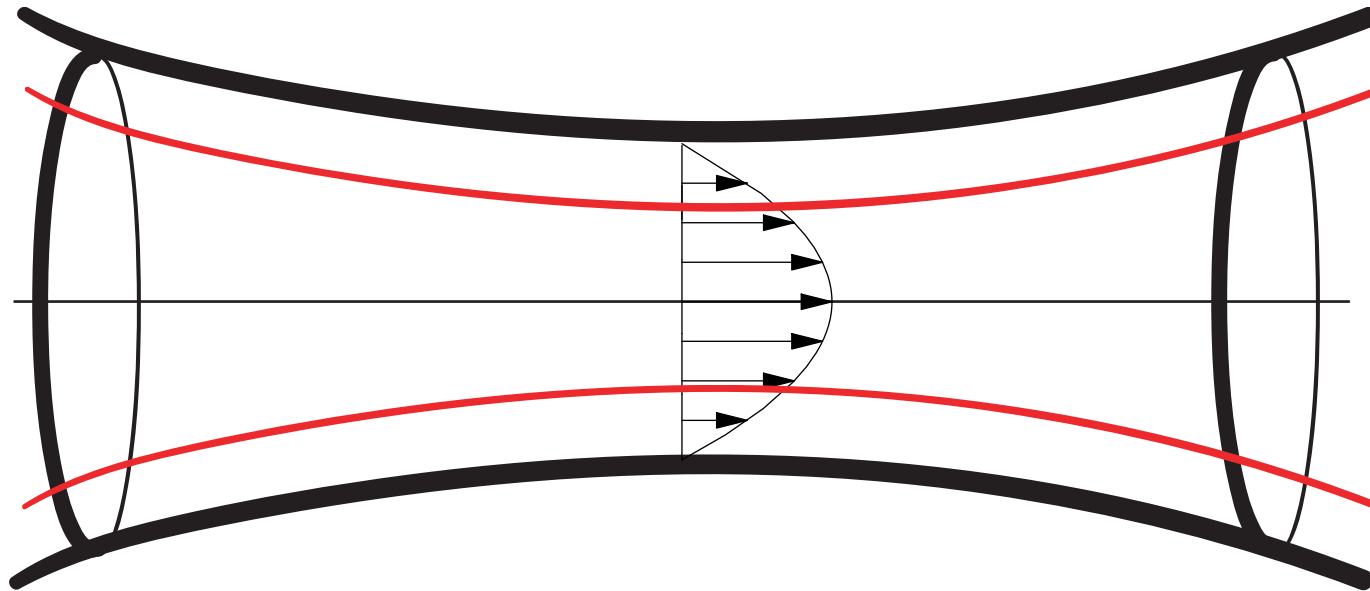

Interactive Boundary Layer

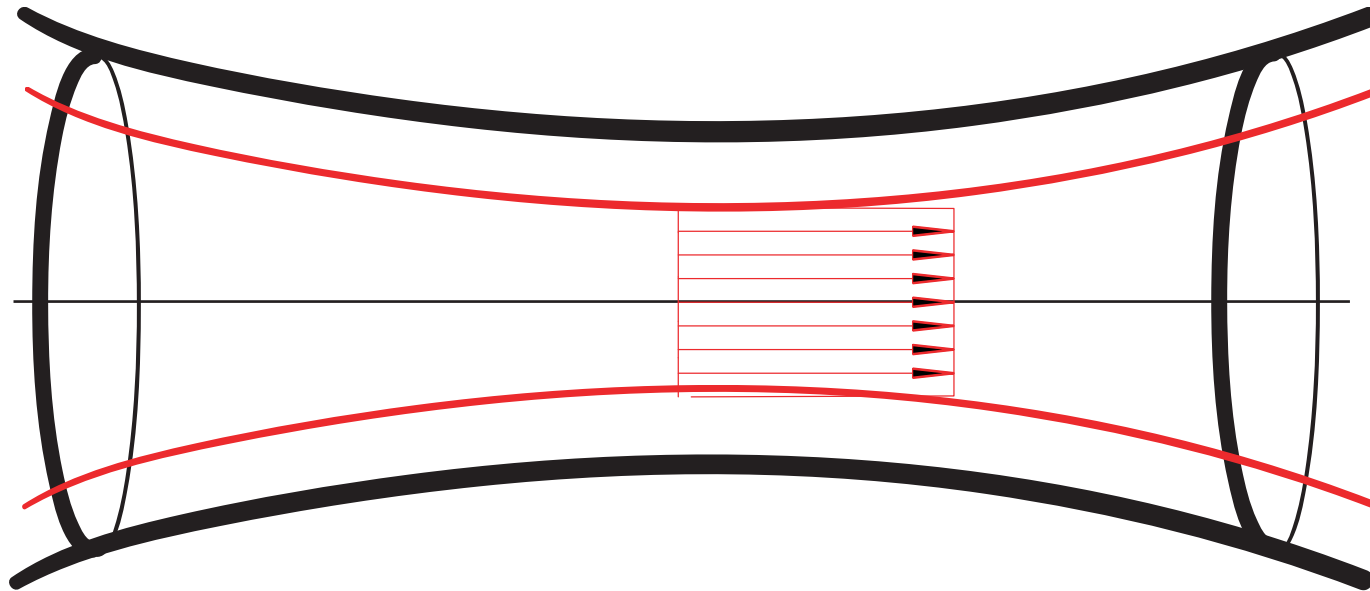

Interactive Boundary Layer

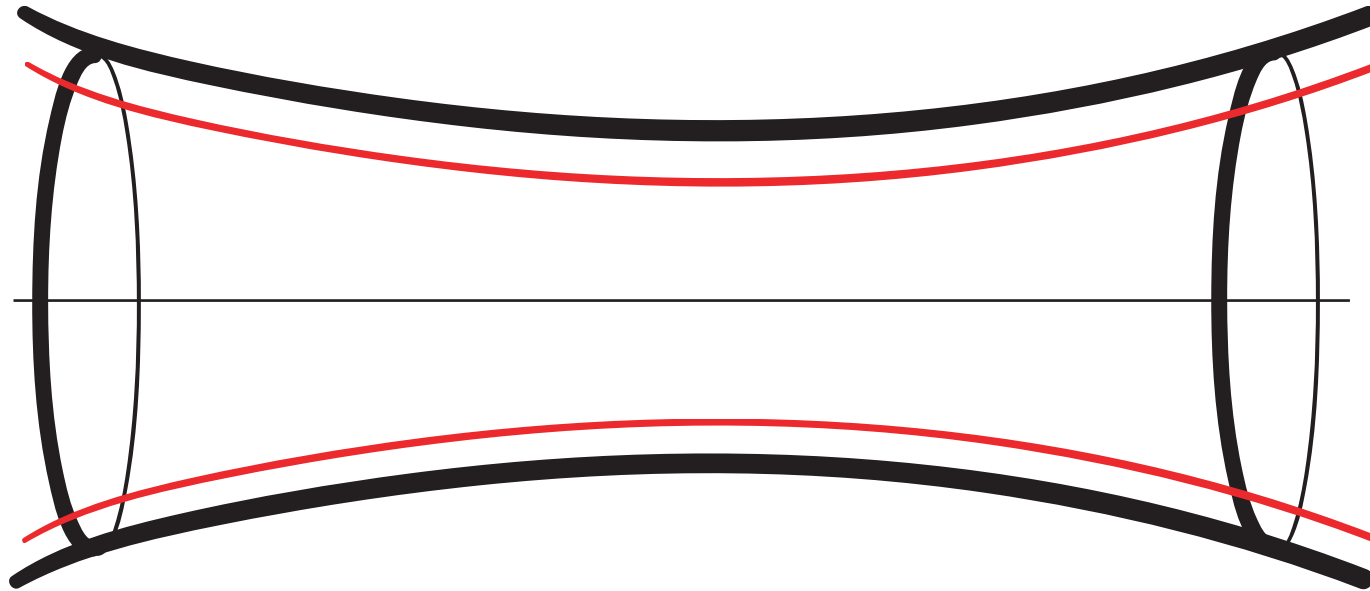

Interactive Boundary Layer

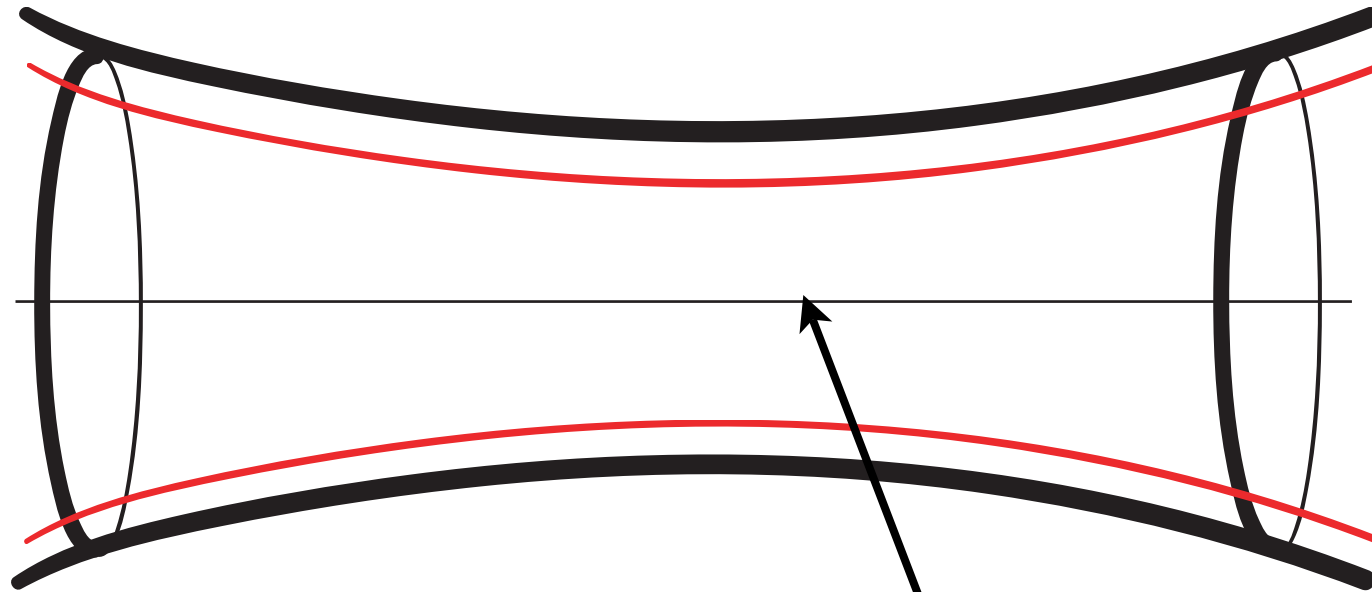

Ideal fluid region
flat profile

Interactive Boundary Layer

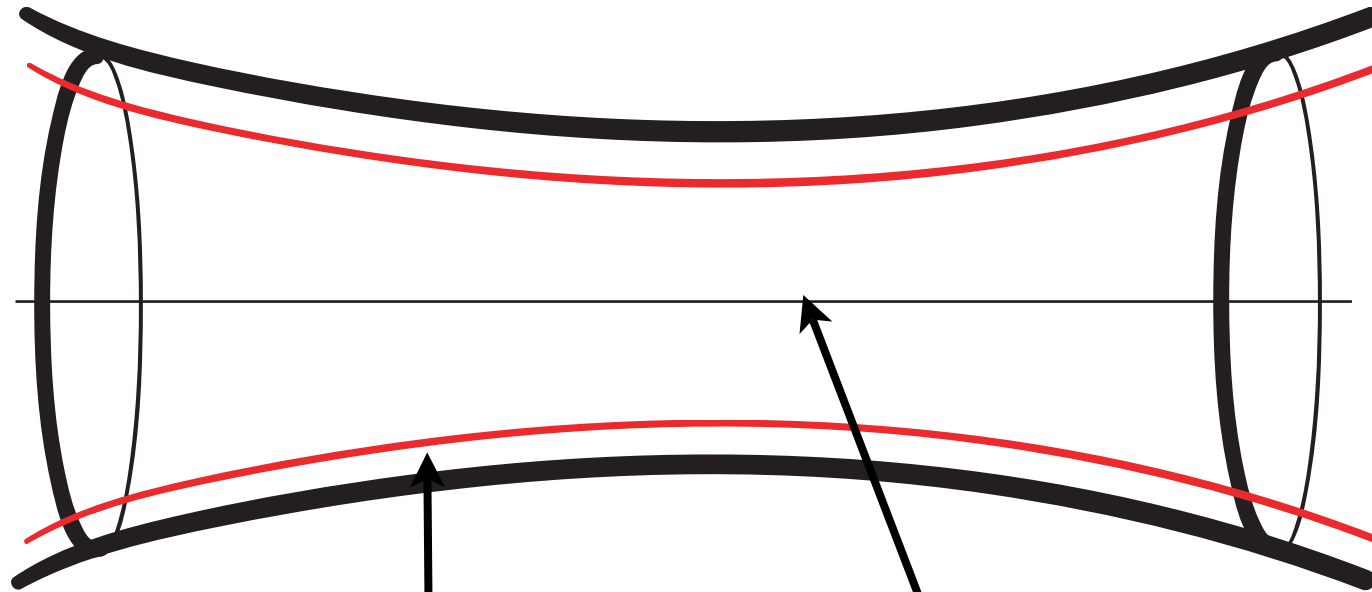

Ideal fluid region
flat profile

Viscous region: boundary layer

Interactive Boundary Layer

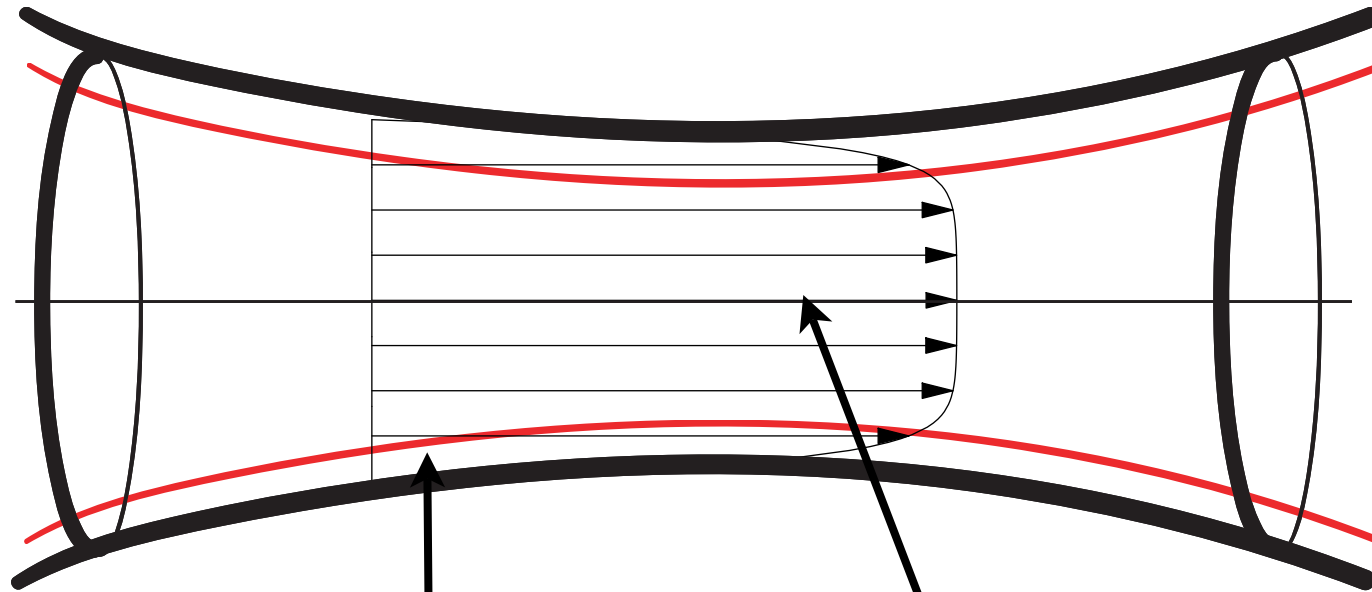

Ideal fluid region
flat profile

Viscous region: boundary layer

Integral resolution

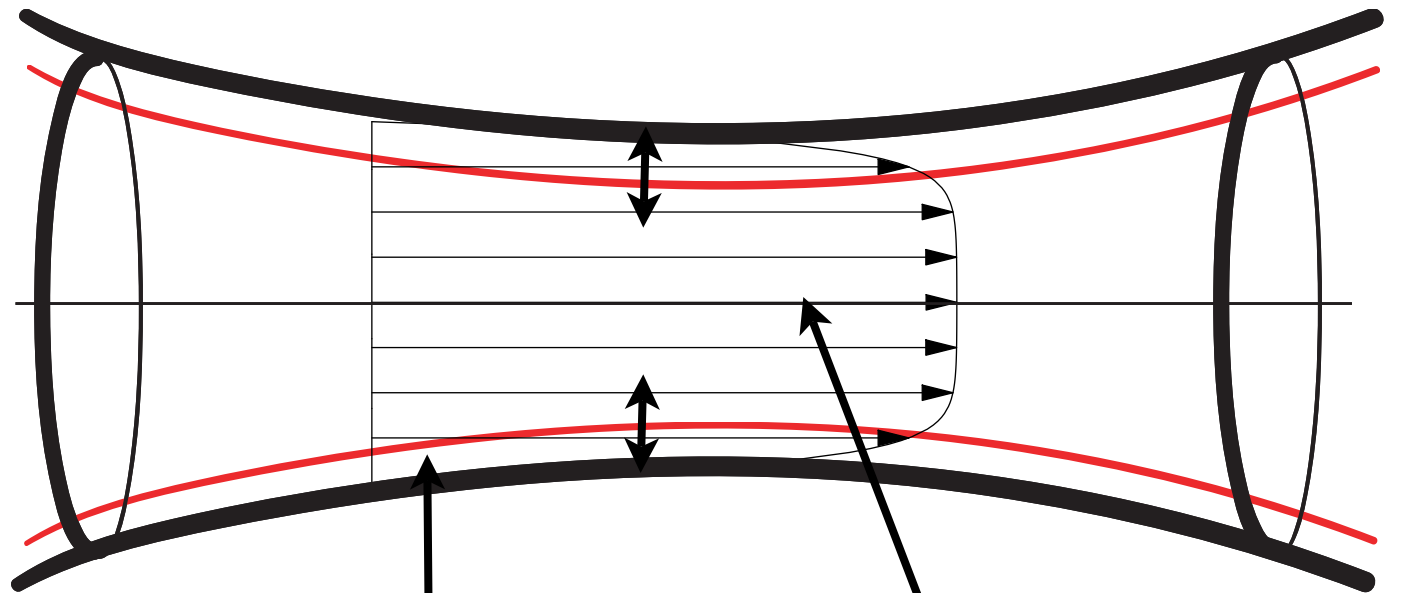

Ideal fluid region
flat profile

Viscous region: boundary layer

Interactive Boundary Layer

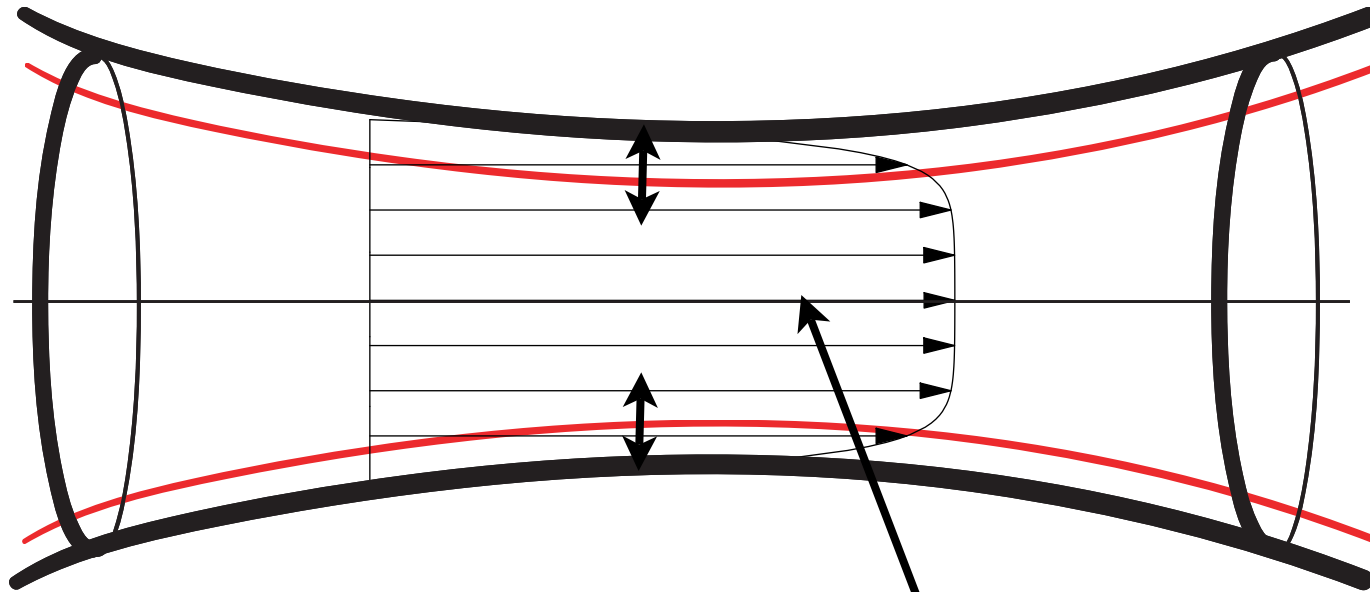

$$\frac{\partial u}{\partial x} + \frac{\partial rv}{r\partial r} = 0$$

Ideal fluid region
flat profile

$$\frac{\partial u}{\partial t} + u \frac{\partial}{\partial x} u + v \frac{\partial}{\partial r} u = -\frac{\partial p}{\rho \partial x} + v \frac{\partial}{r \partial r} r \frac{\partial u}{\partial r} \quad 0 = -\frac{\partial p}{\rho \partial r}$$

Interactive Boundary Layer

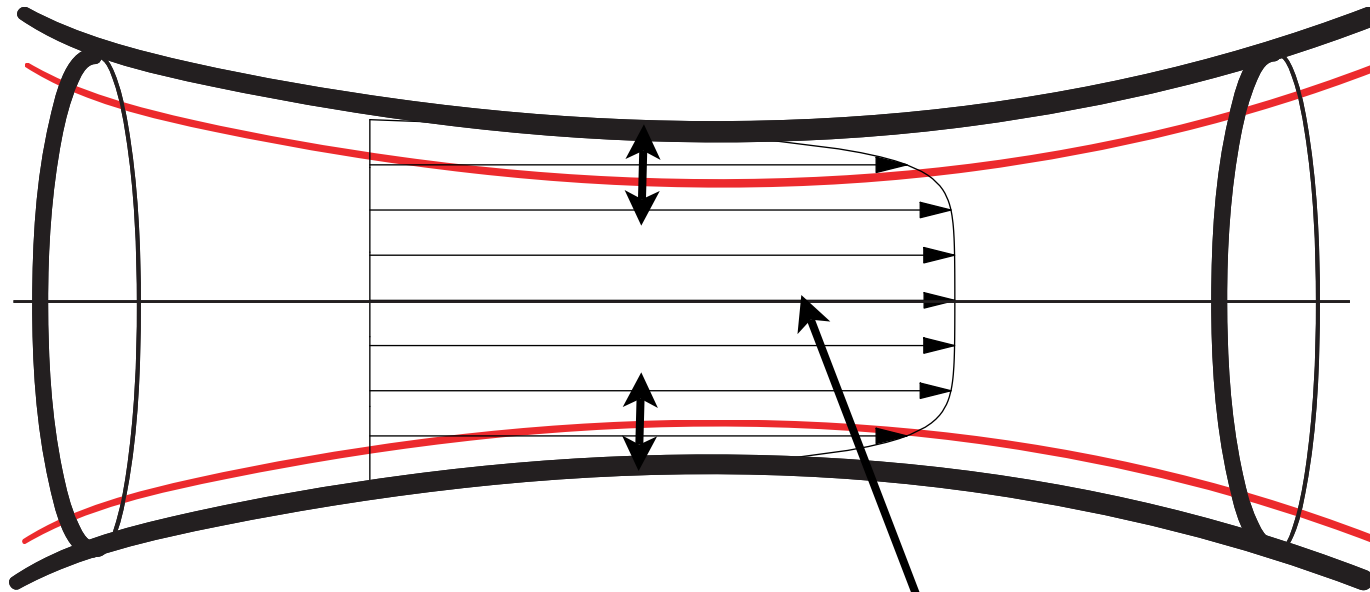

$$\frac{\partial u}{\partial x} + \frac{\partial rv}{r\partial r} = 0$$

Ideal fluid region
flat profile

$$\frac{\partial u}{\partial t} + u \frac{\partial}{\partial x} u + v \frac{\partial}{\partial r} u = -\frac{\partial p}{\rho \partial x} + v \frac{\partial}{\cancel{r\partial r}} \cancel{r} \frac{\partial u}{\partial r} \quad 0 = -\frac{\partial p}{\rho \partial r}$$

Interactive Boundary Layer

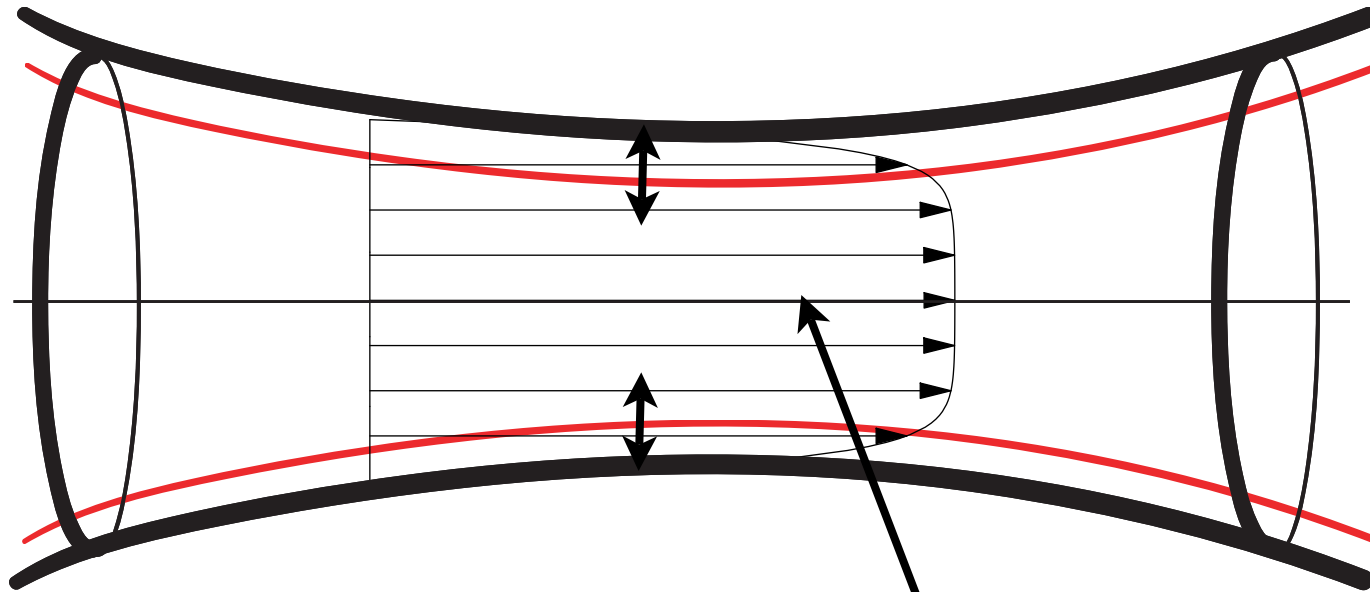

$$\frac{\partial u}{\partial x} + \frac{\partial rv}{r\partial r} = 0$$

Ideal fluid region
flat profile

$$\cancel{\frac{\partial u}{\partial t}} + u \frac{\partial}{\partial x} u + v \frac{\partial}{\partial r} u = -\frac{\partial p}{\rho \partial x} + v \cancel{\frac{\partial}{\partial r}} r \frac{\partial u}{\partial r} \quad 0 = -\frac{\partial p}{\rho \partial r}$$

steady/ or large convective acceleration

Interactive Boundary Layer

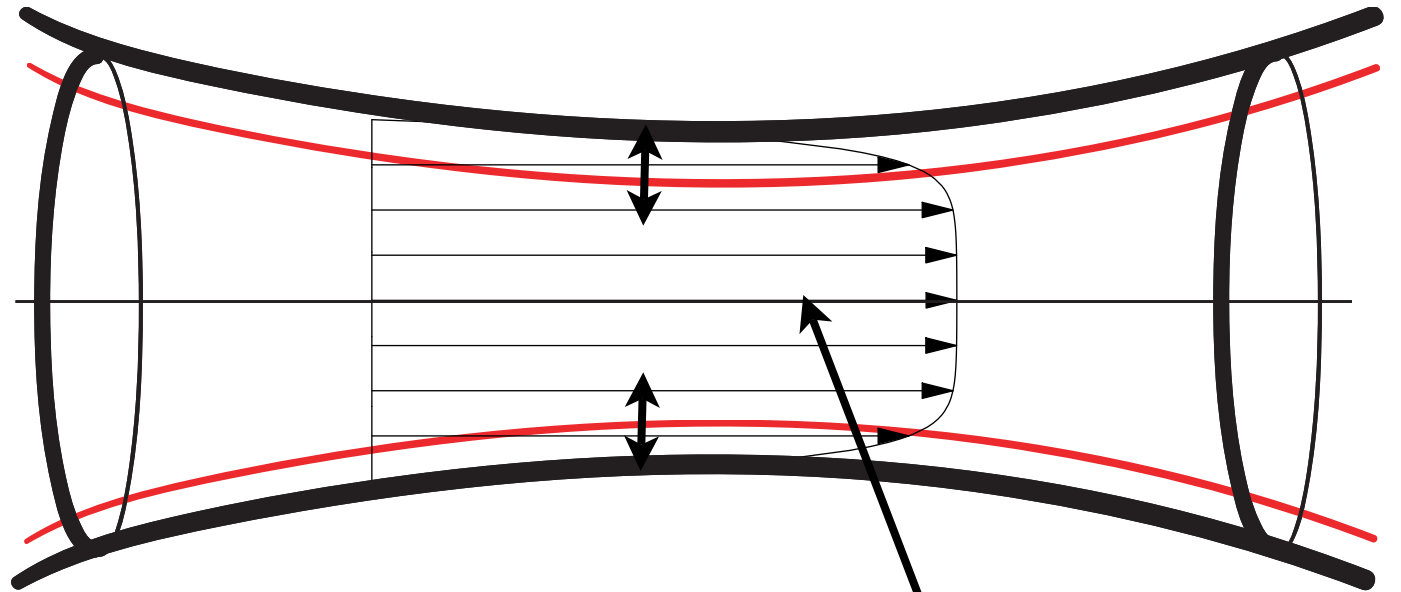

Ideal fluid region
flat profile

$$U_e S = cst$$

Interactive Boundary Layer

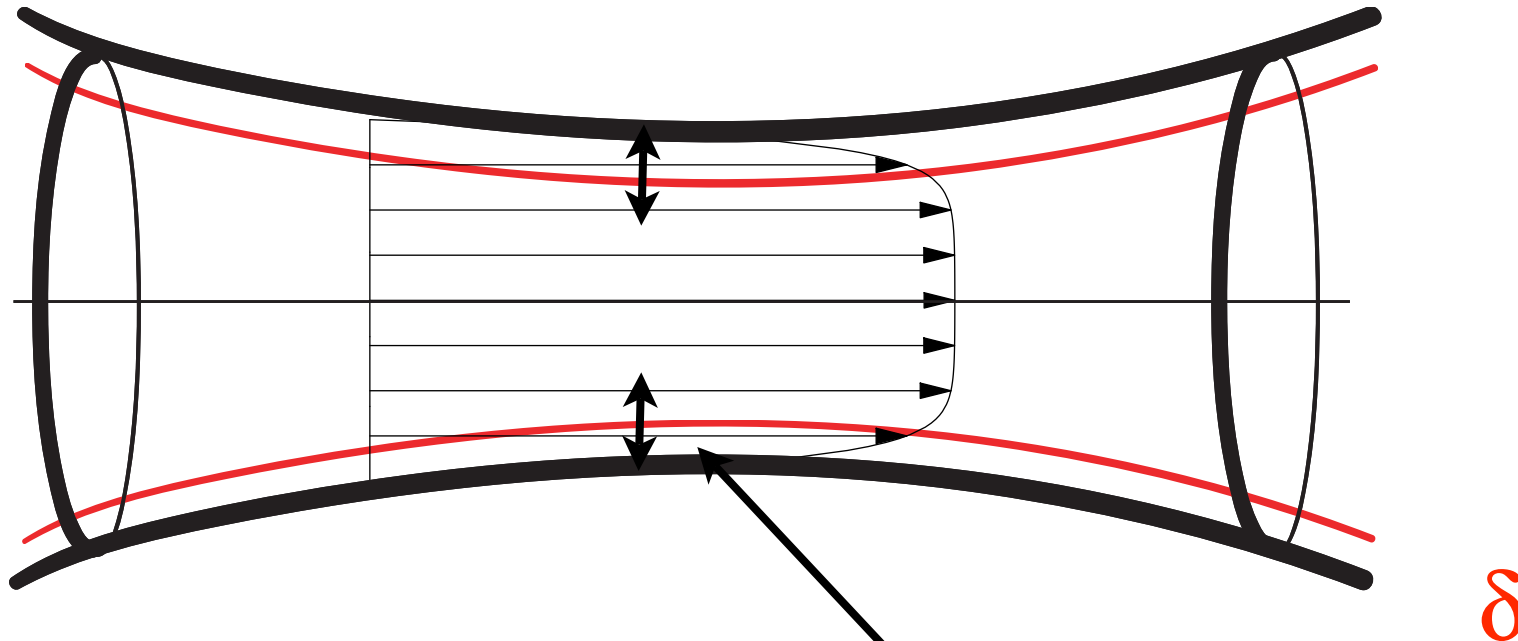

$$\frac{\partial u}{\partial x} + \frac{\partial rv}{r\partial r} = 0$$

Viscous region: boundary layer

$$\cancel{\frac{\partial u}{\partial t}} + u \frac{\partial}{\partial x} u + v \frac{\partial}{\partial r} u = -\frac{\partial p}{\rho \partial x} + v \frac{\partial}{r \partial r} r \frac{\partial u}{\partial r} \quad 0 = -\frac{\partial p}{\rho \partial r}$$

steady/ or large convective acceleration

Interactive Boundary Layer

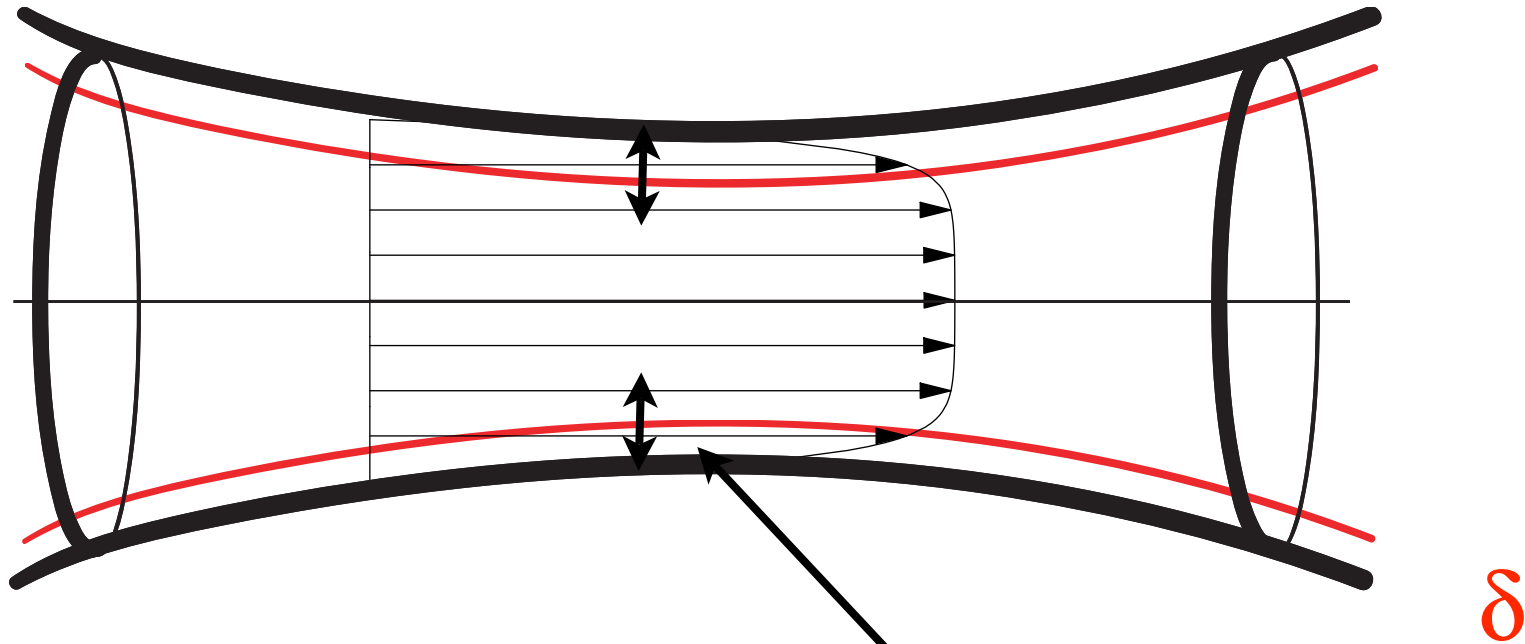

$$\frac{\partial u}{\partial x} + \frac{\partial rv}{r\partial r} = 0$$

Viscous region: boundary layer

$$\boxed{\frac{U_0^2}{\lambda}} = -\frac{\partial p}{\rho \partial x} + \boxed{\frac{v}{U_0 \lambda} \frac{\lambda^2}{\delta^2} \frac{U_0^2}{\lambda}} \quad 0 = -\frac{\partial p}{\rho \partial r}$$

steady/ or large convective acceleration

Interactive Boundary Layer

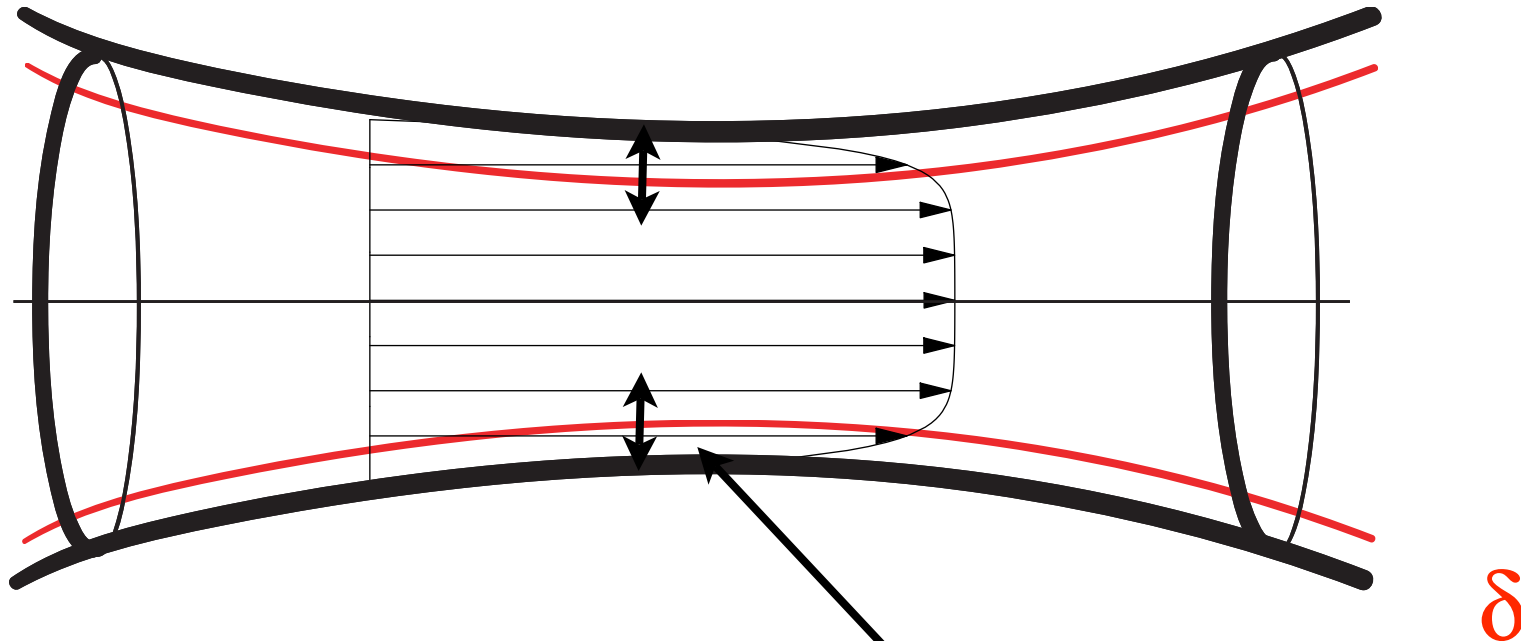

$$\frac{\partial u}{\partial x} + \frac{\partial rv}{r \partial r} = 0$$

Viscous region: boundary layer

$$\boxed{\frac{U_0^2}{\lambda}} = -\frac{\partial p}{\rho \partial x} + \boxed{\frac{1}{Re} \frac{\lambda^2 U_0^2}{\delta^2 \lambda}} = -\frac{\partial p}{\rho \partial r}$$

steady/ or large convective acceleration

Interactive Boundary Layer

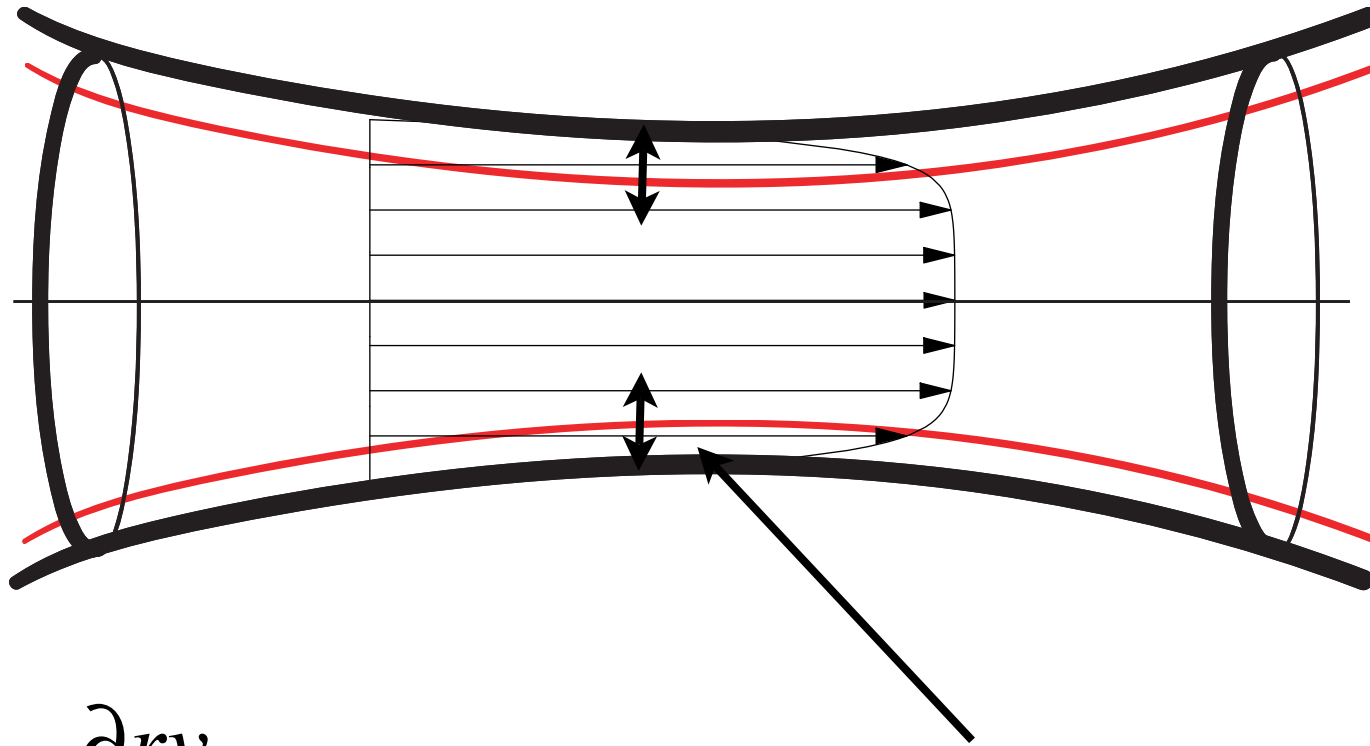

$$\delta \sim \frac{\lambda}{Re^{1/2}}$$

$$\frac{\partial u}{\partial x} + \frac{\partial rv}{r \partial r} = 0$$

Viscous region: boundary layer

$$\frac{U_0^2}{\lambda} = -\frac{\partial p}{\rho \partial x} + \frac{1}{Re} \frac{\lambda^2 U_0^2}{\delta^2 \lambda} = -\frac{\partial p}{\rho \partial r}$$

Interactive Boundary Layer

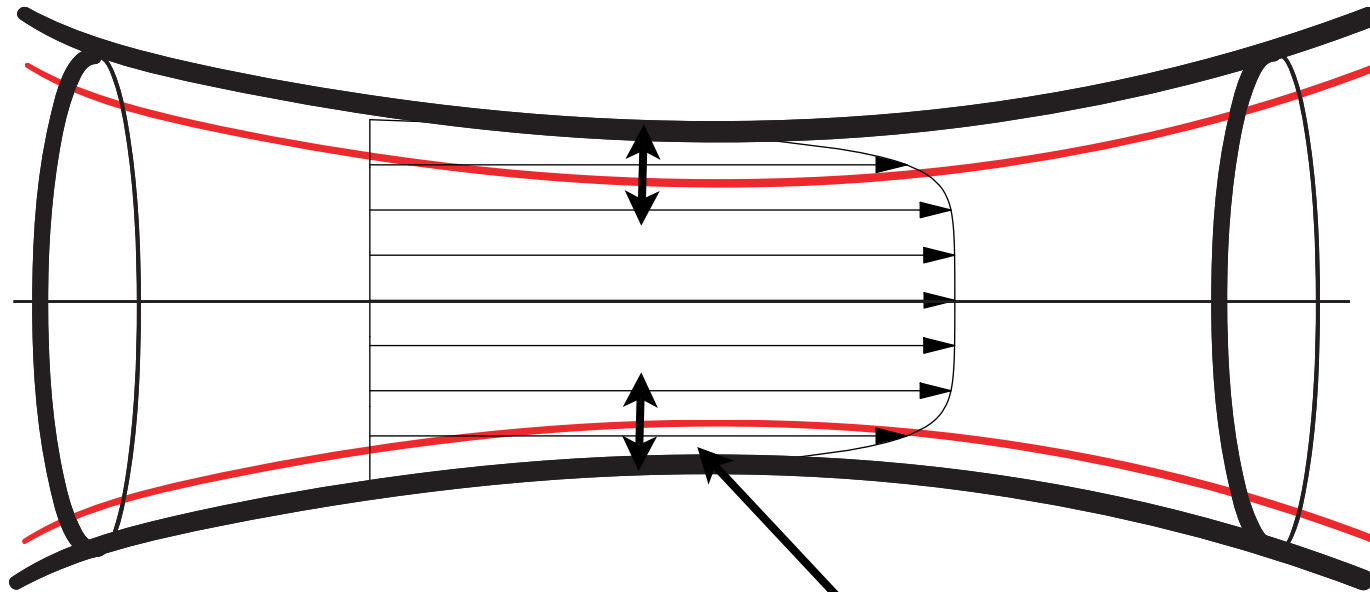

$$\delta \sim \frac{\lambda}{Re^{1/2}}$$

$$\frac{\partial u}{\partial x} + \frac{\partial v}{\partial n} = 0$$

Viscous region: boundary layer

$$\boxed{u \frac{\partial}{\partial x} u + v \frac{\partial}{\partial n} u} = -\frac{\partial p}{\partial x} + \boxed{\frac{\partial^2}{\partial n^2} u} \quad 0 = -\frac{\partial p}{\partial n}$$

Interactive Boundary Layer

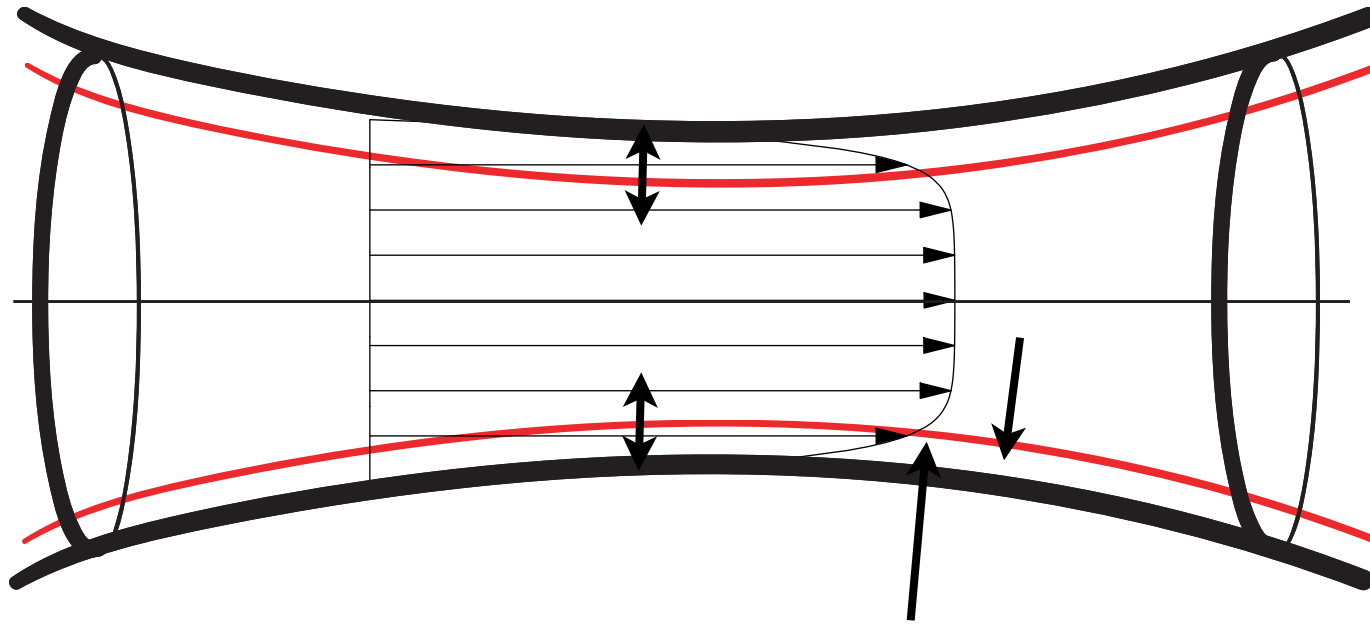

$$\frac{\partial u}{\partial x} + \frac{\partial v}{\partial n} = 0$$

Matching of velocity
from invicid/ viscous

$$u \frac{\partial}{\partial x} u + v \frac{\partial}{\partial n} u = -\frac{\partial p}{\partial x} + \frac{\partial^2}{\partial n^2} u \quad 0 = -\frac{\partial p}{\partial n}$$

Interactive Boundary Layer

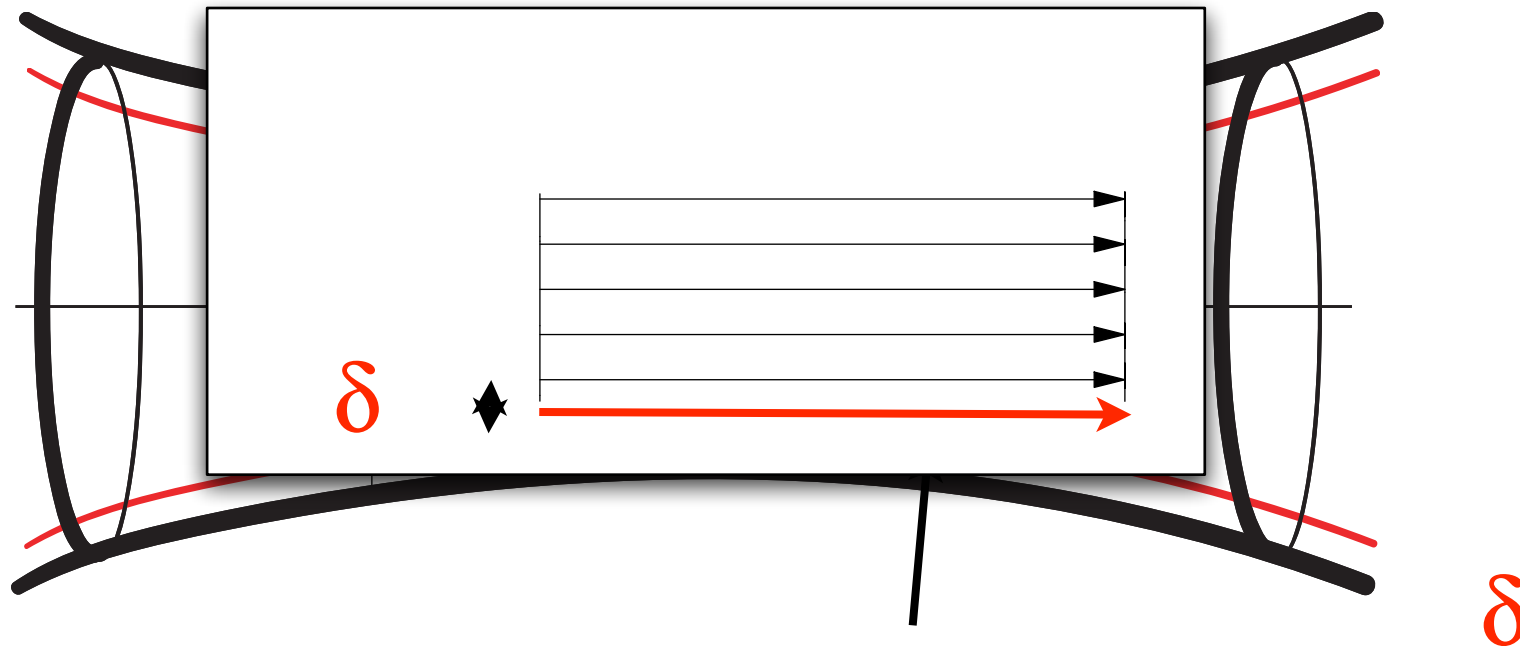

Matching of velocity
from invicid/ viscous

U_e at the wall

Interactive Boundary Layer

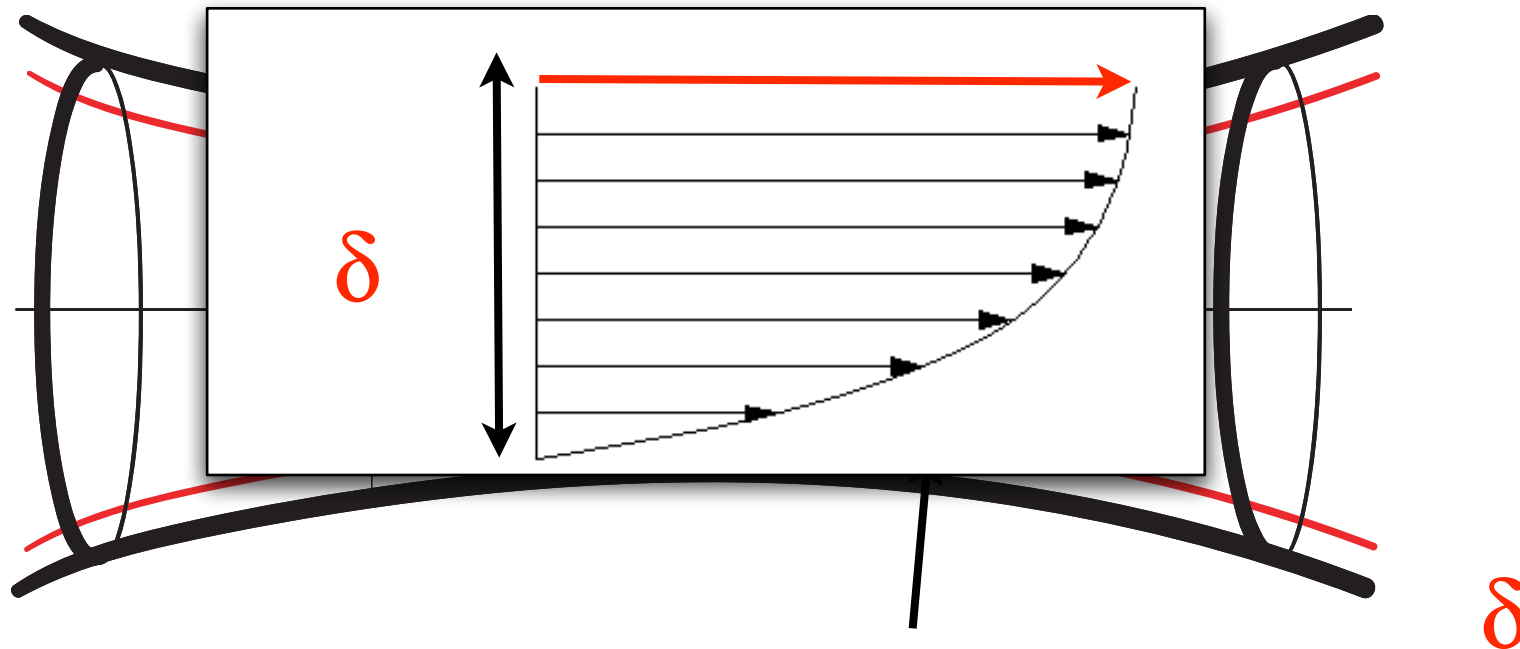

Matching of velocity
from invicid/ viscous

U_e at the wall

is the velocity at the edge of the boundary layer at "infinity" $u(x, \infty)$

Interactive Boundary Layer

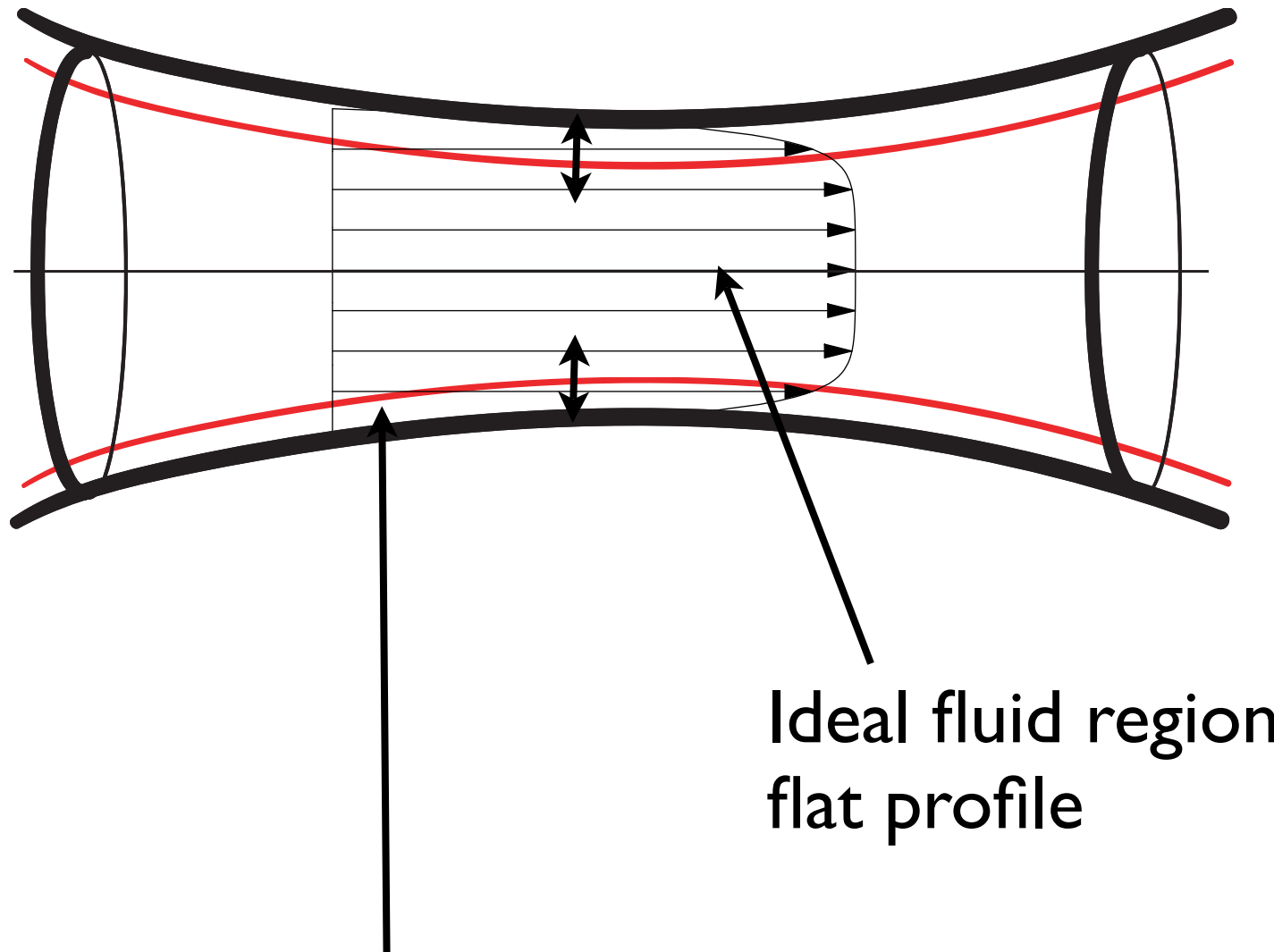

Ideal fluid region
flat profile

$$\delta_1 = \int_0^{\infty} \left(1 - \frac{u}{U_e}\right) dn$$

displacement of stream lines

Interactive Boundary Layer

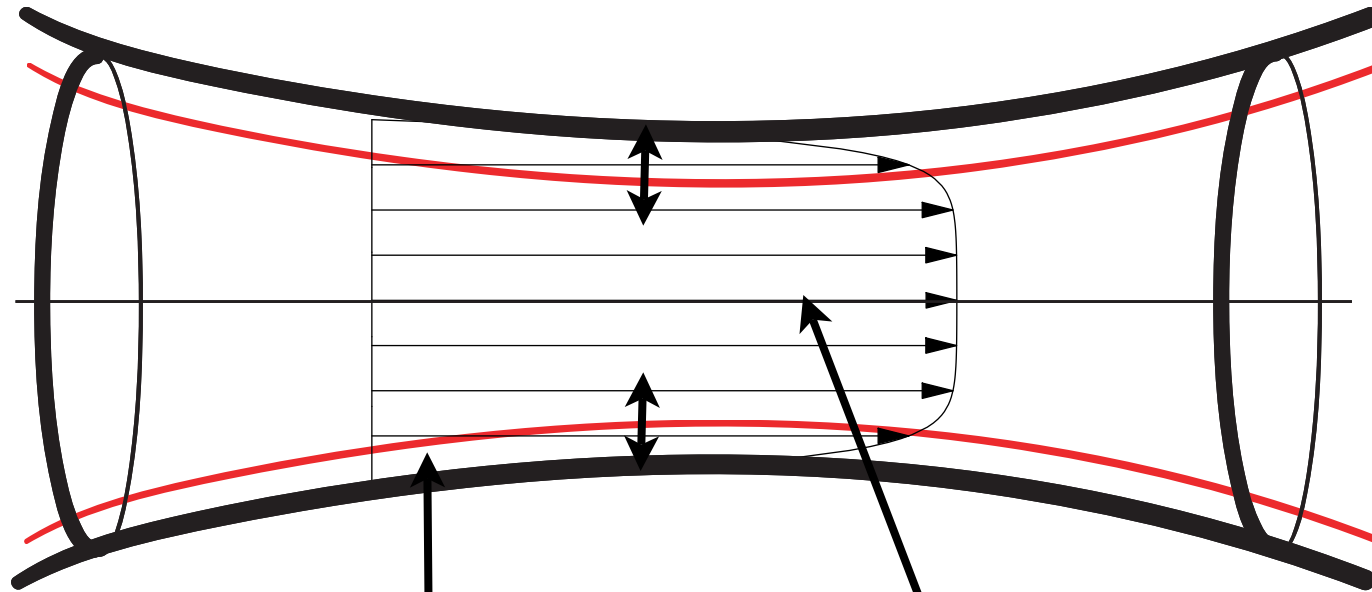

Ideal fluid region
flat profile perturbed by the
boundary layer thickness

$$\delta_1 = \int_0^{\infty} \left(1 - \frac{u}{U_e}\right) dn$$

Interactive Boundary Layer

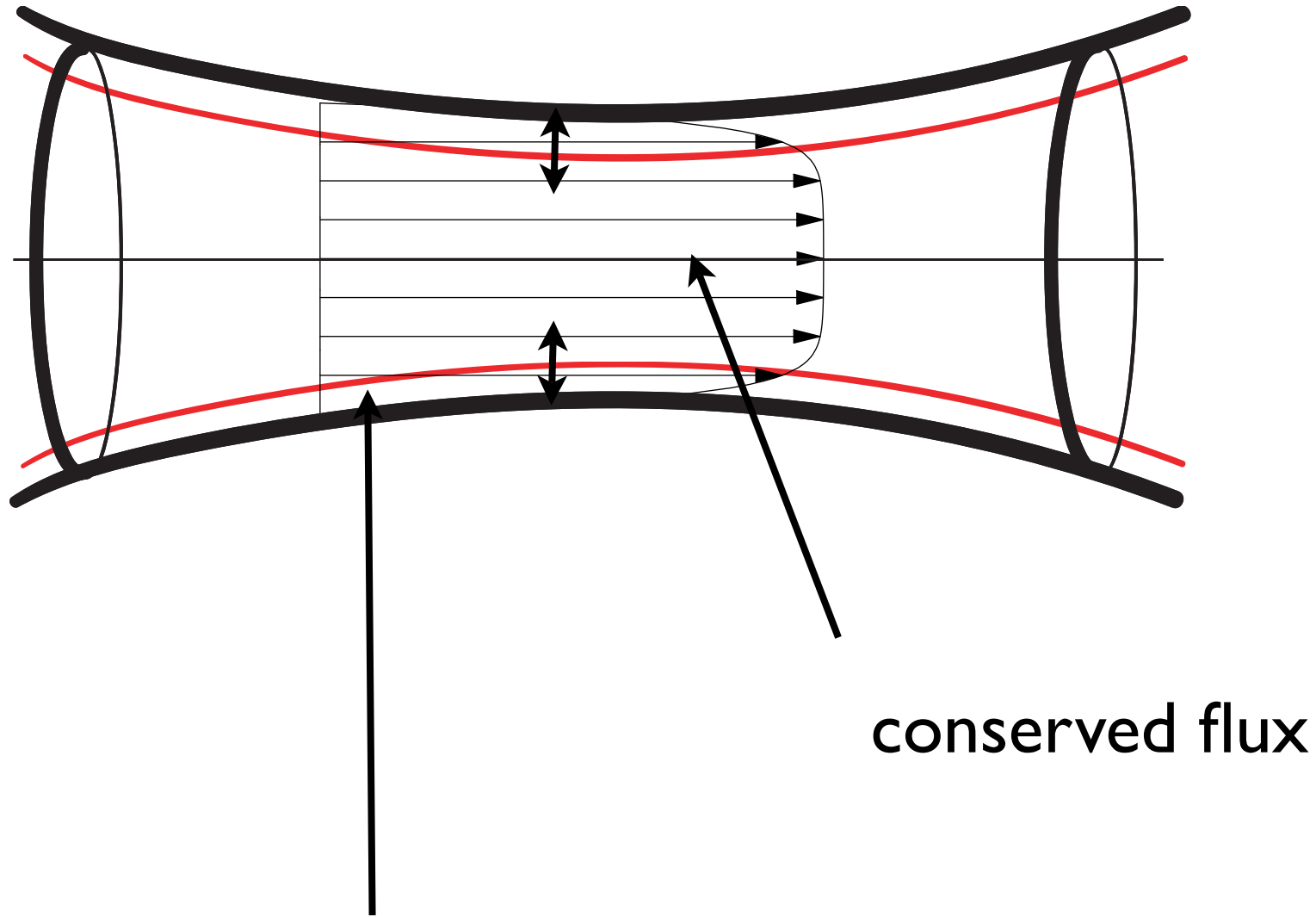

$$\delta_1 = \int_0^{\infty} \left(1 - \frac{u}{U_e}\right) dn$$

Interactive Boundary Layer

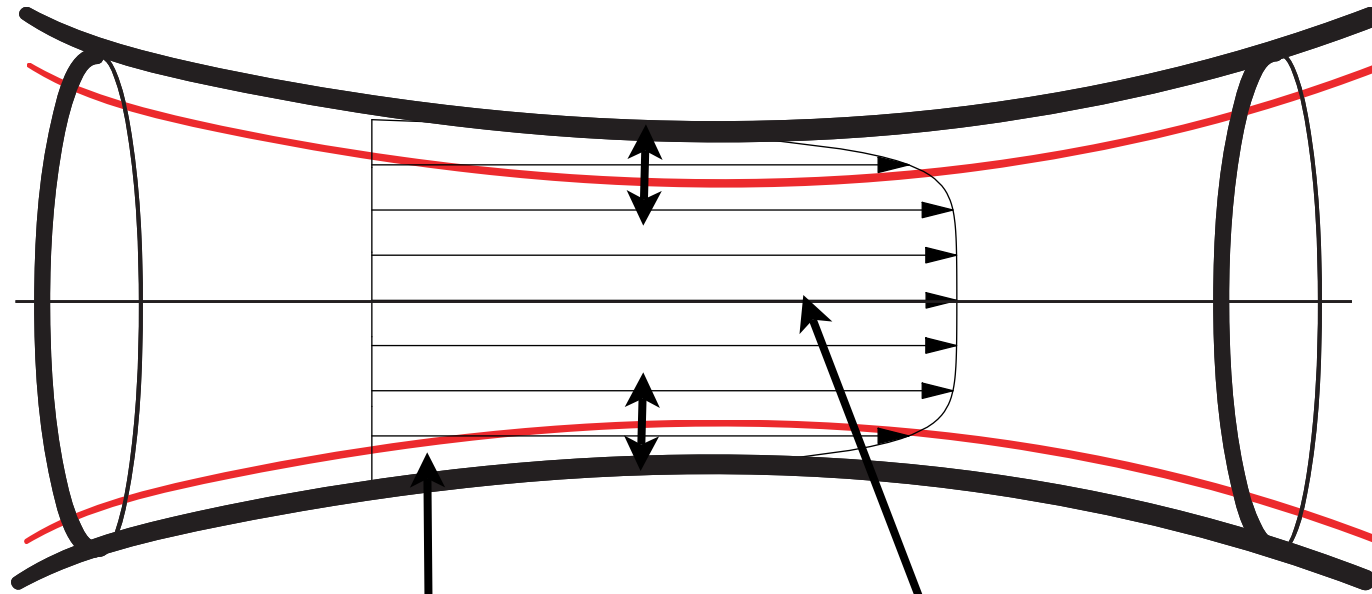

$$U_e(1 - (f + \delta_1))^2 = 1$$

$$\delta_1 = \int_0^{\infty} \left(1 - \frac{u}{U_e}\right) dn$$

Interactive Boundary Layer

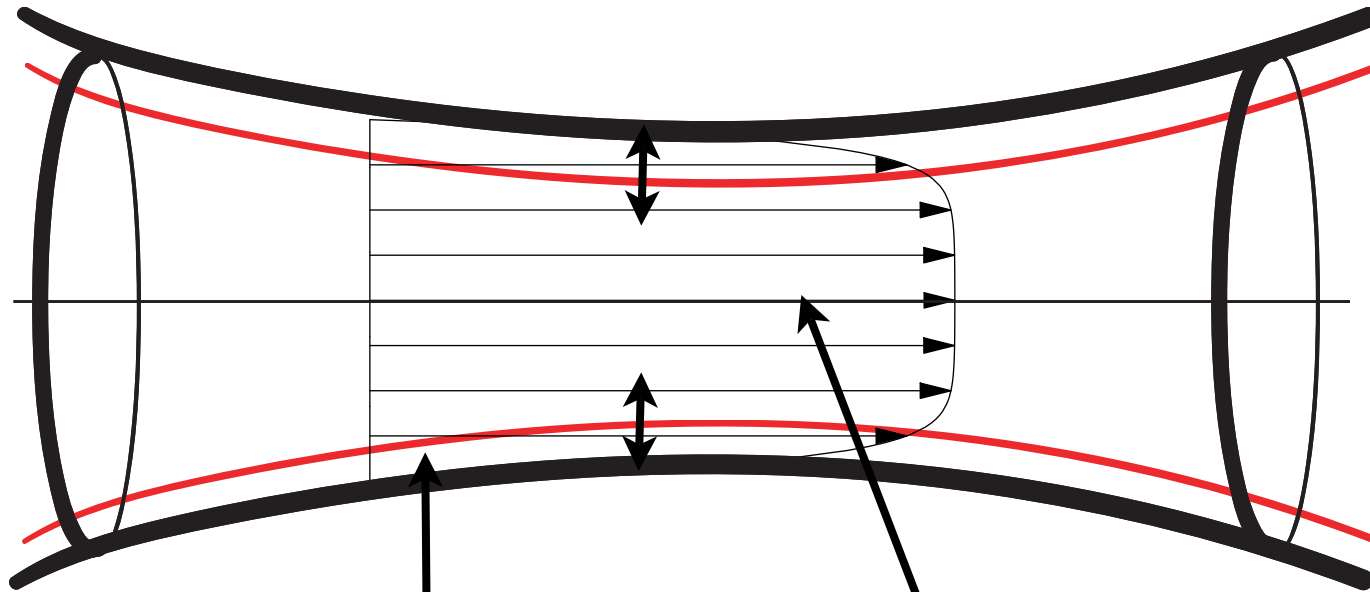

$$U_e(1 - (f + \delta_1))^2 = 1$$

$$\delta_1 = \int_0^\infty \left(1 - \frac{u}{U_e}\right) dn$$

$$\frac{\partial u}{\partial x} + \frac{\partial v}{\partial n} = 0$$

$$u \frac{\partial}{\partial x} u + v \frac{\partial}{\partial n} u = \frac{dU_e}{dx} + \frac{\partial^2}{\partial n^2} u$$

Interactive Boundary Layer

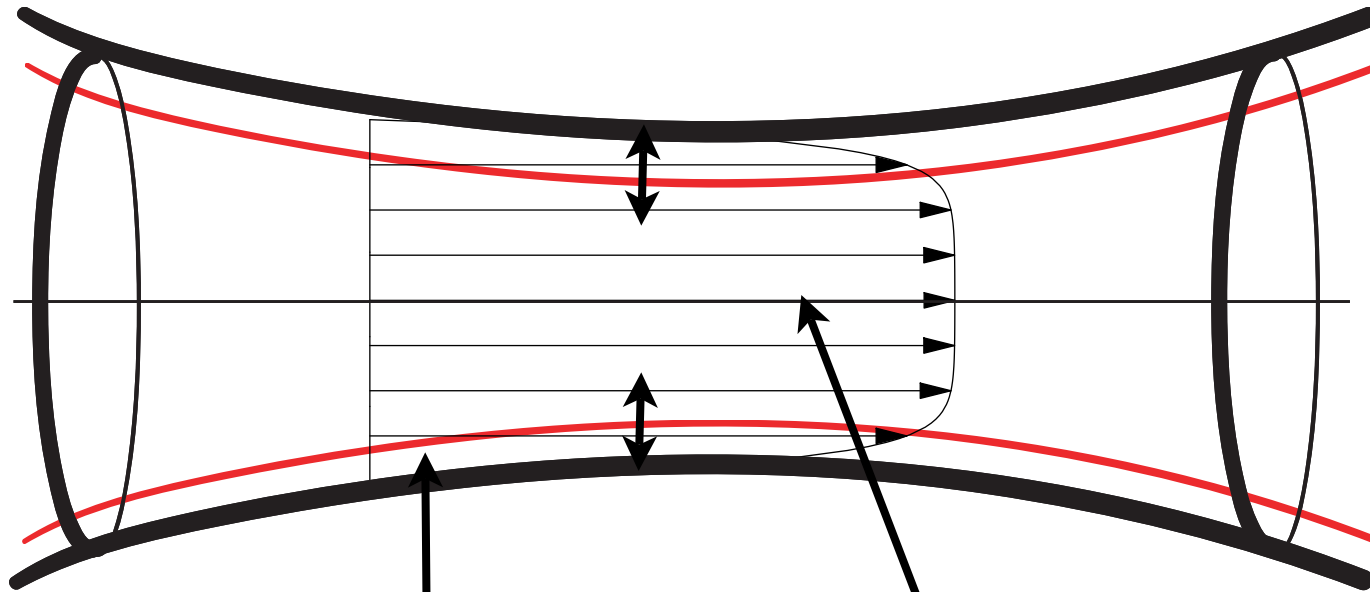

$$\delta_1 = \int_0^{\infty} \left(1 - \frac{u}{U_e}\right) dn$$

$$U_e(1 - (f + \delta_1))^2 = 1$$

$$\frac{\partial u}{\partial x} + \frac{\partial v}{\partial n} = 0 \quad u(x, \infty) = U_e$$

$$u \frac{\partial}{\partial x} u + v \frac{\partial}{\partial n} u = \frac{dU_e}{dx} + \frac{\partial^2}{\partial n^2} u$$

Interactive Boundary Layer

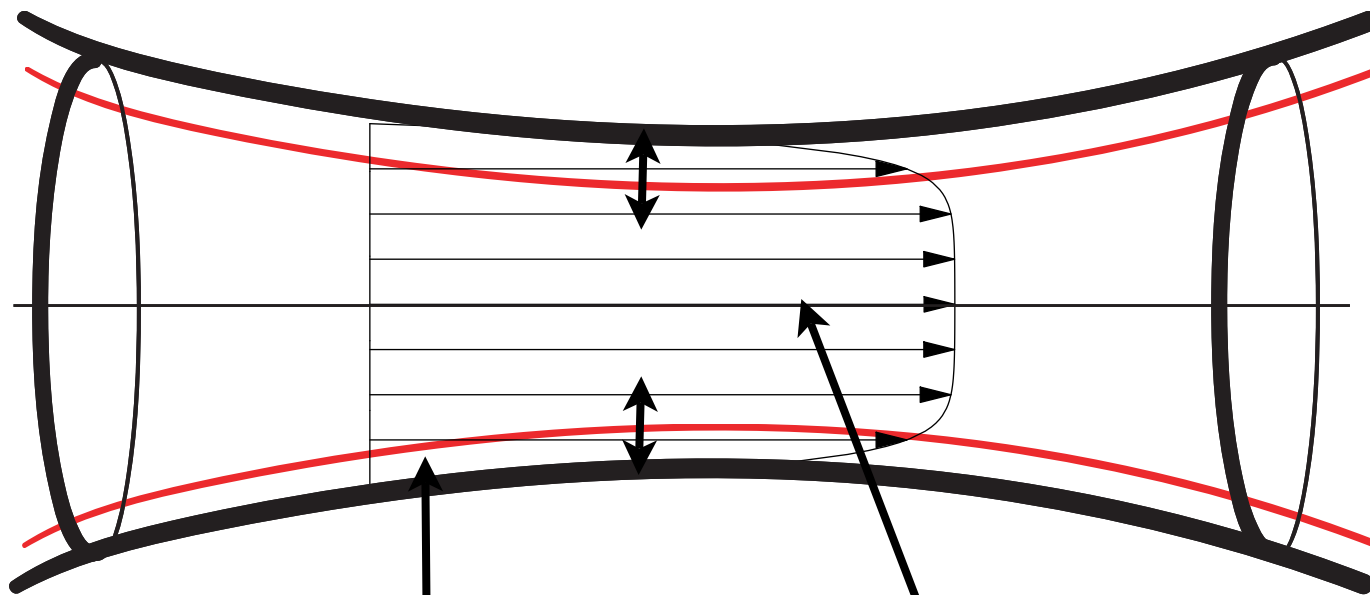

$$\delta_1 = \int_0^\infty \left(1 - \frac{u}{U_e}\right) dn$$

$$U_e(1 - (f + \delta_1))^2 = 1$$

$$\frac{\partial u}{\partial x} + \frac{\partial v}{\partial n} = 0 \quad u(x, \infty) = U_e$$
$$u \frac{\partial}{\partial x} u + v \frac{\partial}{\partial n} u = \frac{dU_e}{dx} + \frac{\partial^2}{\partial n^2} u$$

Interactive Boundary Layer

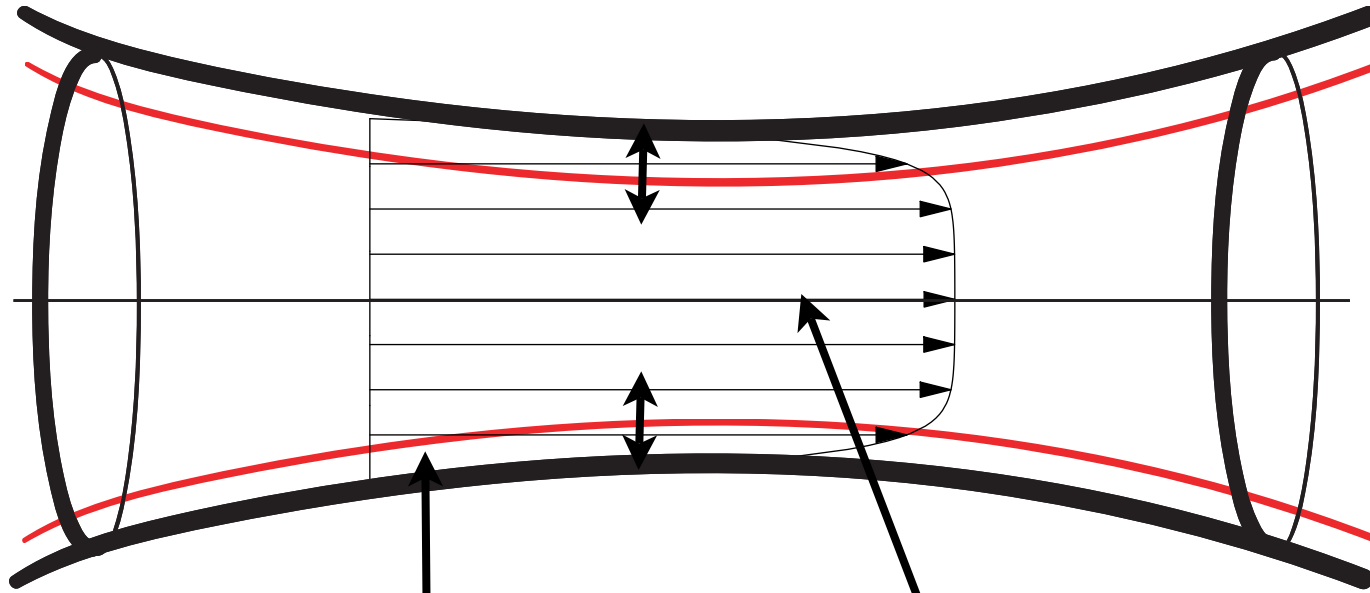

$$\delta_1 = \int_0^{\infty} \left(1 - \frac{u}{U_e}\right) dn$$

$$U_e(1 - (f + \delta_1))^2 = 1$$

$$\frac{\partial u}{\partial x} + \frac{\partial v}{\partial n} = 0 \quad u(x, \infty) = U_e$$

$$u \frac{\partial}{\partial x} u + v \frac{\partial}{\partial n} u = \frac{dU_e}{dx} + \frac{\partial^2}{\partial n^2} u$$

Interactive Boundary Layer

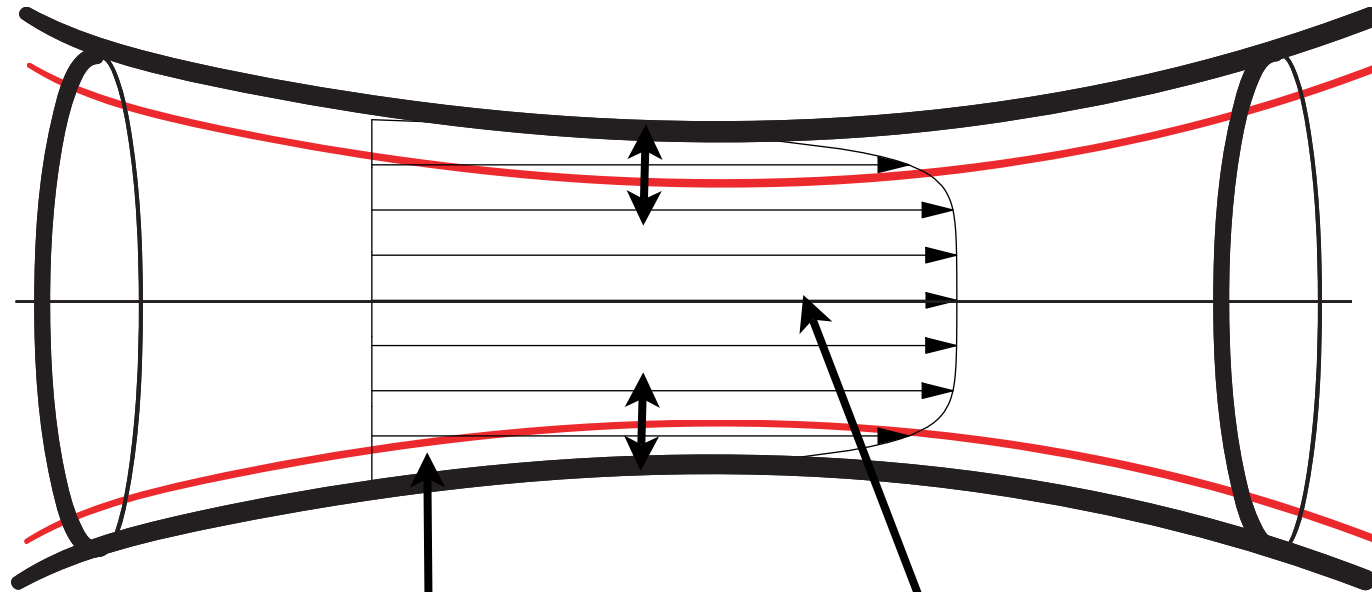

Coupled System to solve

$$U_e(1 - (f + \delta_1))^2 = 1$$

$$\frac{\partial u}{\partial x} + \frac{\partial v}{\partial n} = 0$$

$$u(x, \infty) = U_e$$

$$u \frac{\partial}{\partial x} u + v \frac{\partial}{\partial n} u = \frac{dU_e}{dx} + \frac{\partial^2}{\partial n^2} u$$

$$\delta_1 = \int_0^\infty \left(1 - \frac{u}{U_e}\right) dn$$

Interactive Boundary Layer

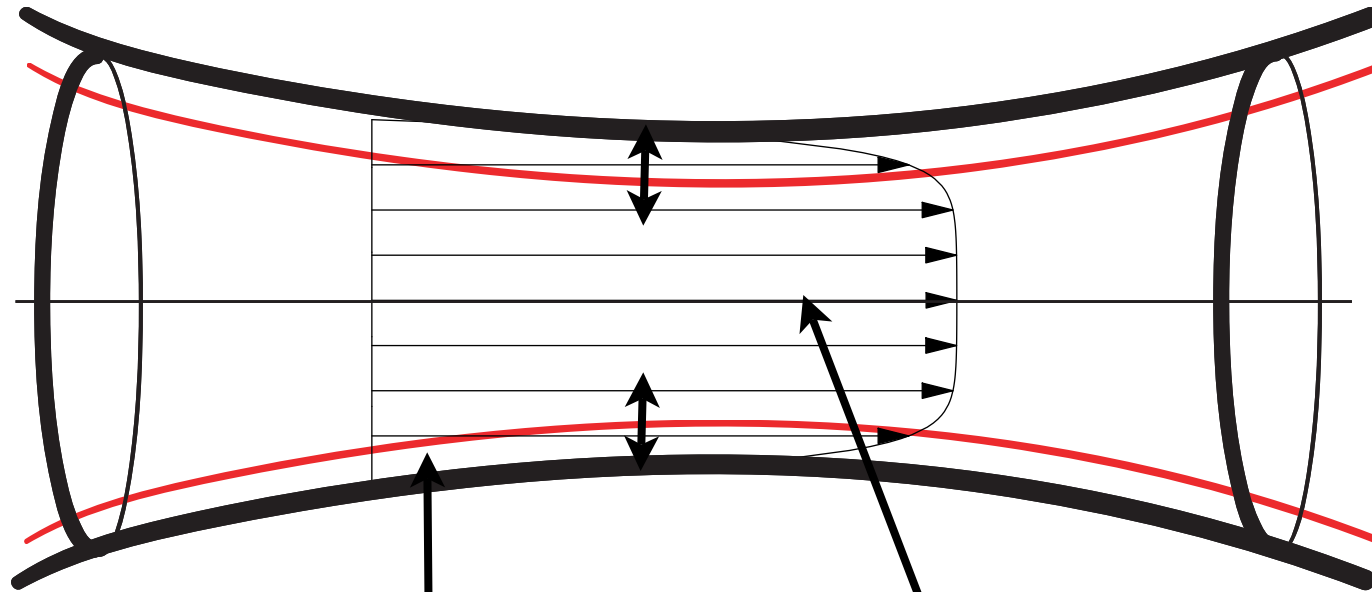

Coupled System to solve

$$U_e(1 - (f + \delta_1))^2 = 1$$

$$\delta_1 = \int_0^\infty \left(1 - \frac{u}{U_e}\right) dn$$

$$\frac{\partial u}{\partial x} + \frac{\partial v}{\partial n} = 0 \quad u(x, \infty) = U_e$$

$$u \frac{\partial u}{\partial x} + v \frac{\partial u}{\partial n} = \frac{dU_e}{dx} + \frac{\partial^2 u}{\partial n^2}$$

Integral resolution equation in steady case

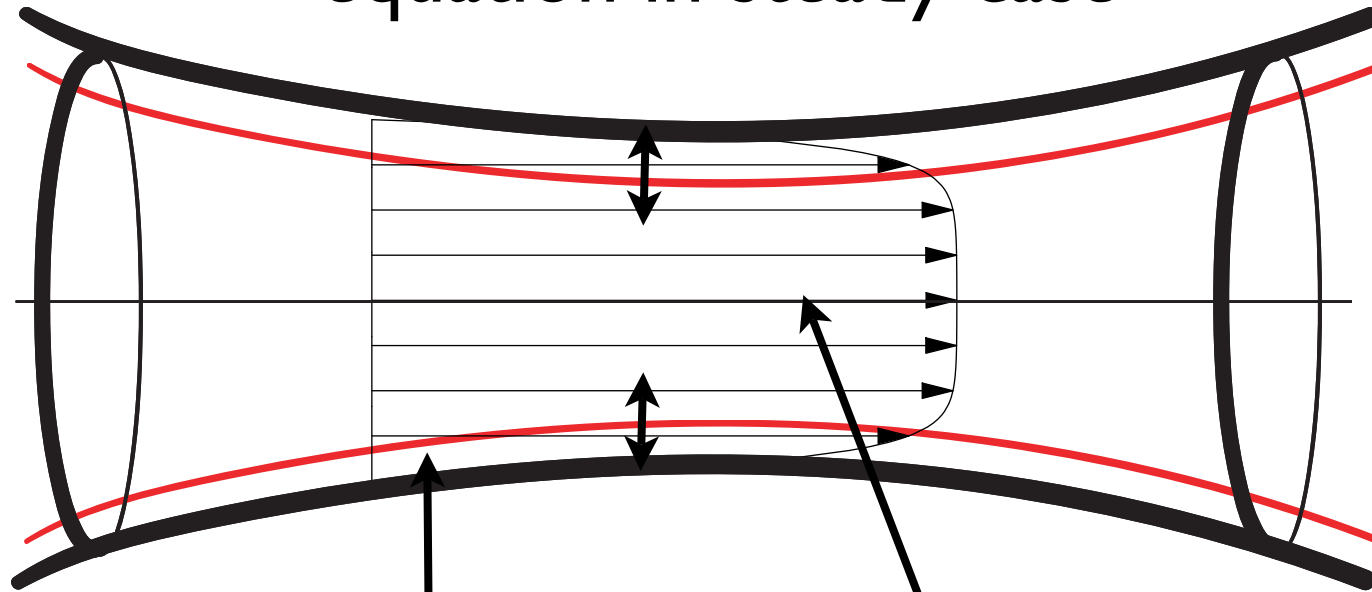

Coupled System to solve

$$U_e(1 - (f + \delta_1))^2 = 1$$

$$\delta_1 = \int_0^\infty \left(1 - \frac{u}{U_e}\right) dn$$

$$\frac{d}{dx} \left(\frac{\delta_1}{H} \right) + \frac{\delta_1}{U_e} \left(1 + \frac{2}{H} \right) \frac{dU_e}{dx} = \frac{f_2 H}{\delta_1 U_e}$$

Interactive Boundary Layer

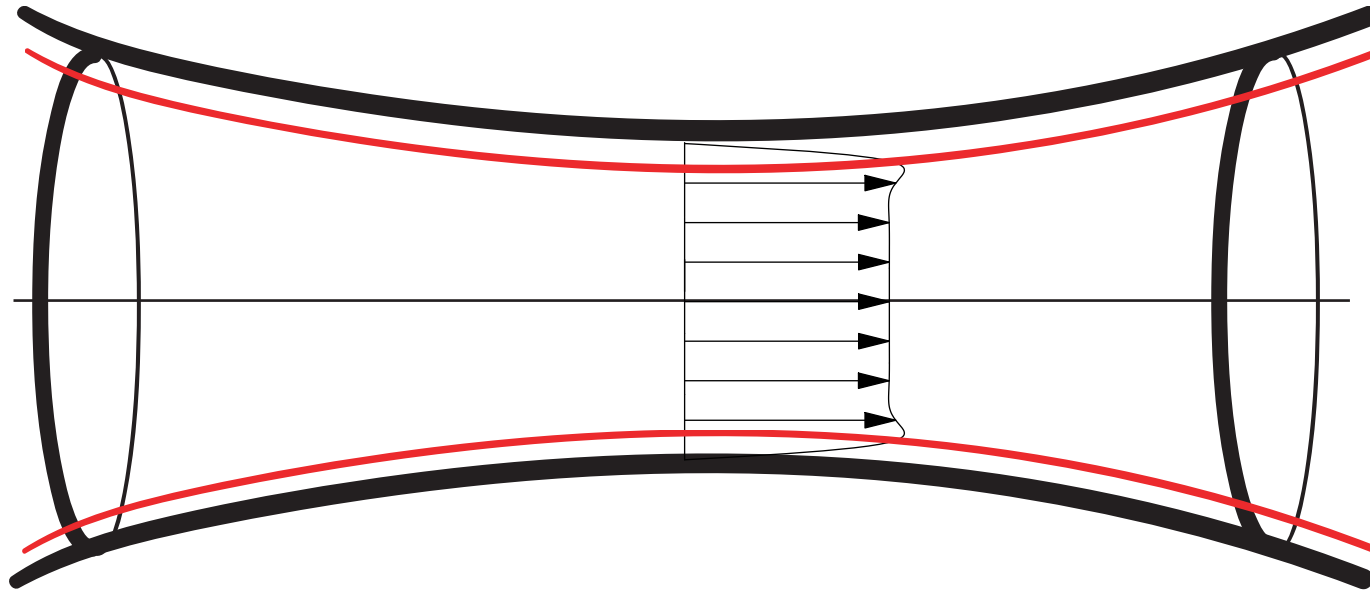

IBL is included in RNSP

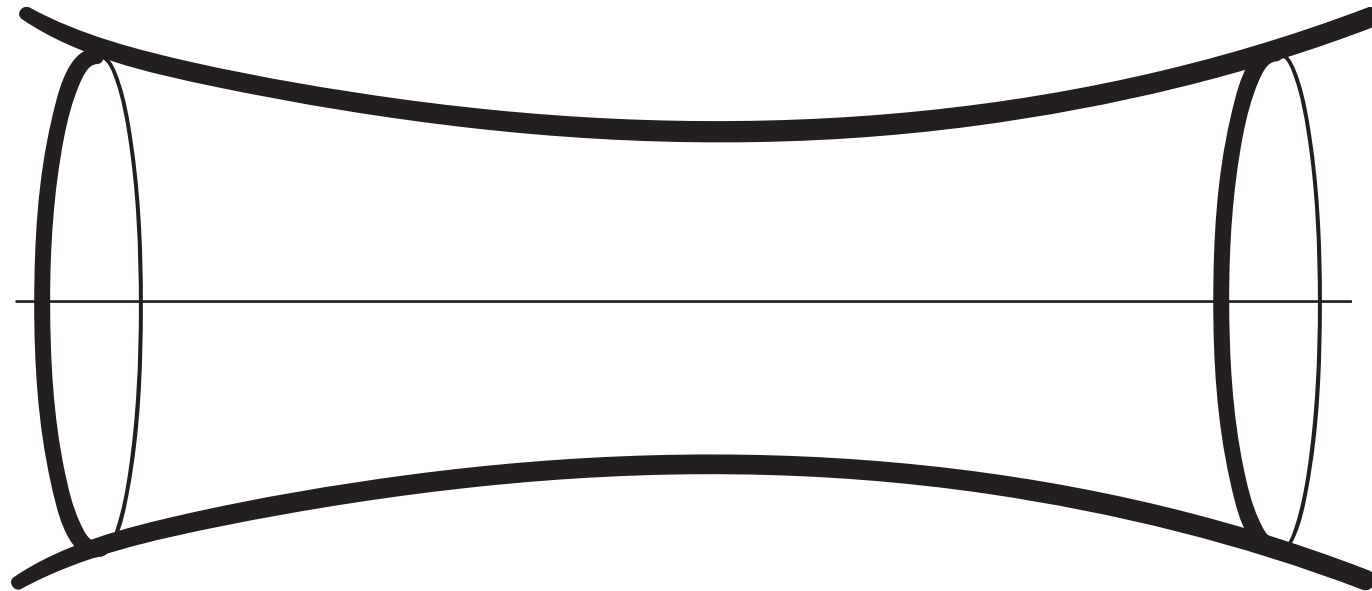

RNSP includes usual 1D equations

RNSP includes Womersley profiles

RNSP includes Boundary Layer Theories (IBL)

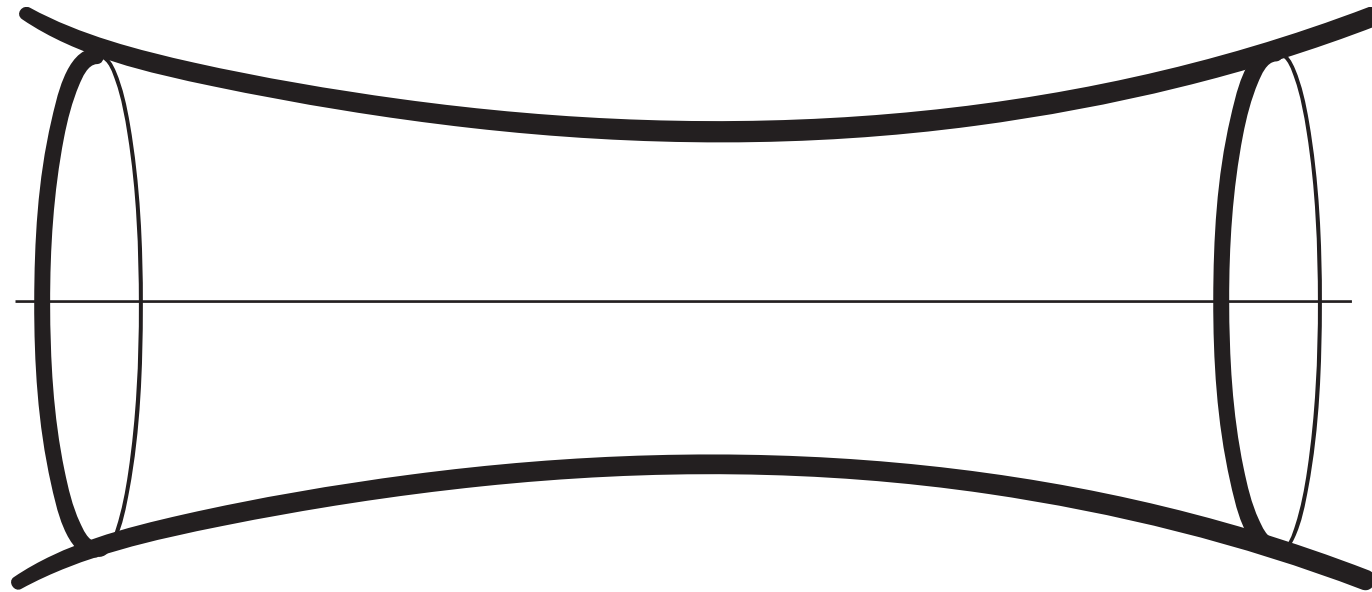

Comparisons

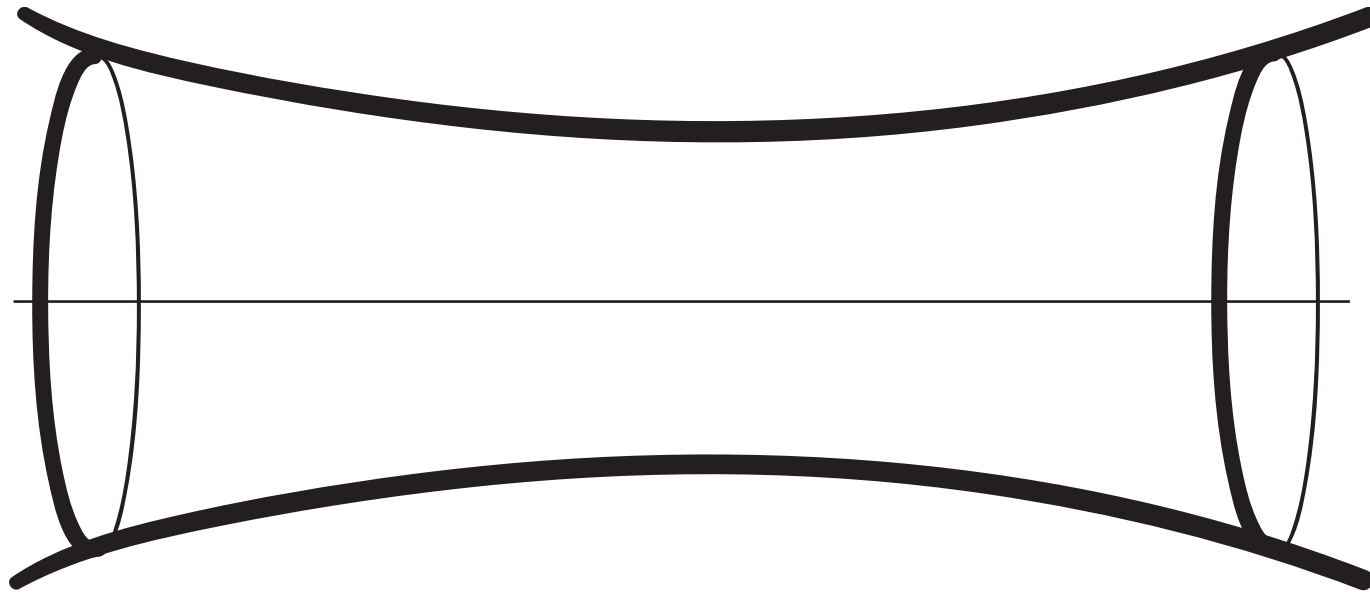

Comparisons

Integral/ ID

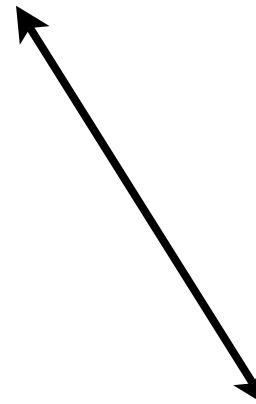

full Navier Stokes
Castem/ FreeFEM

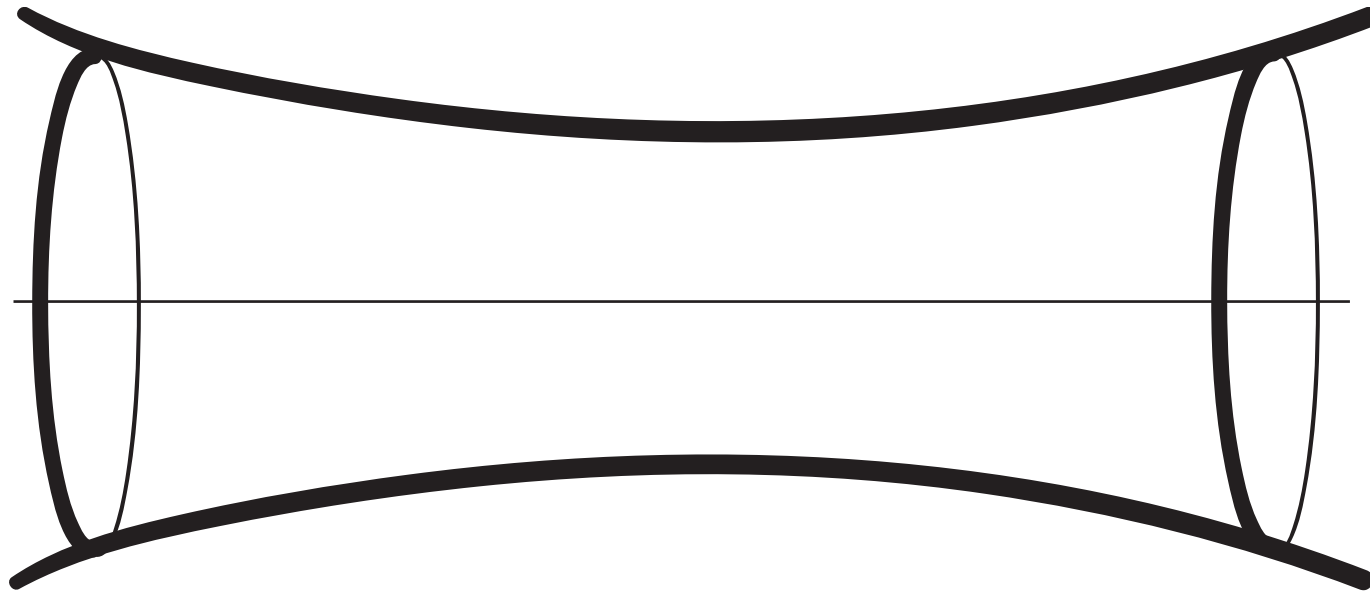

Comparisons

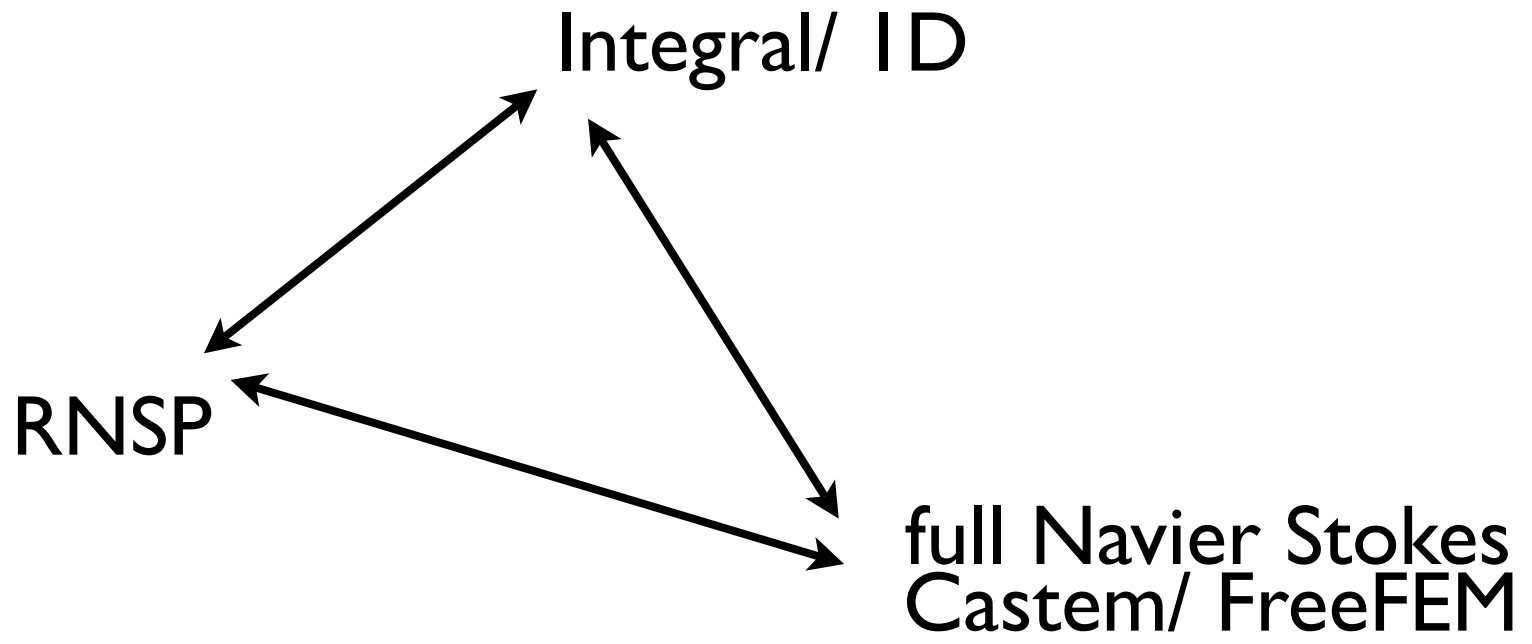

Example I

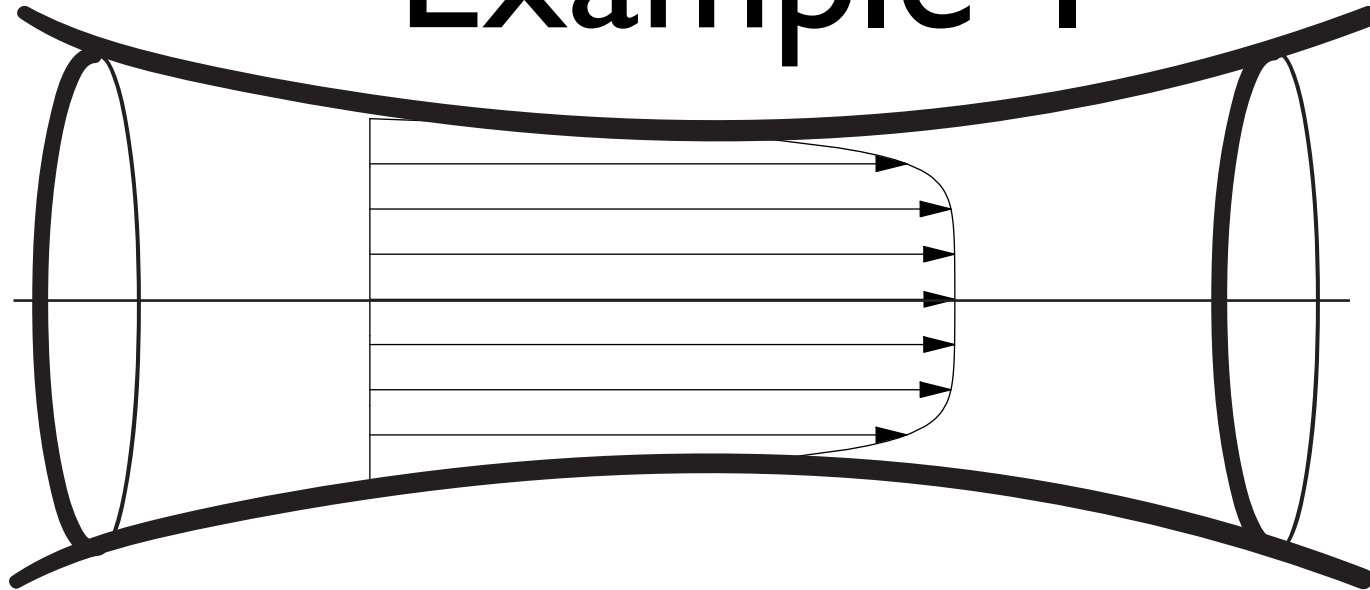

- Flow in a stenosed vessel
- steady, rigid wall

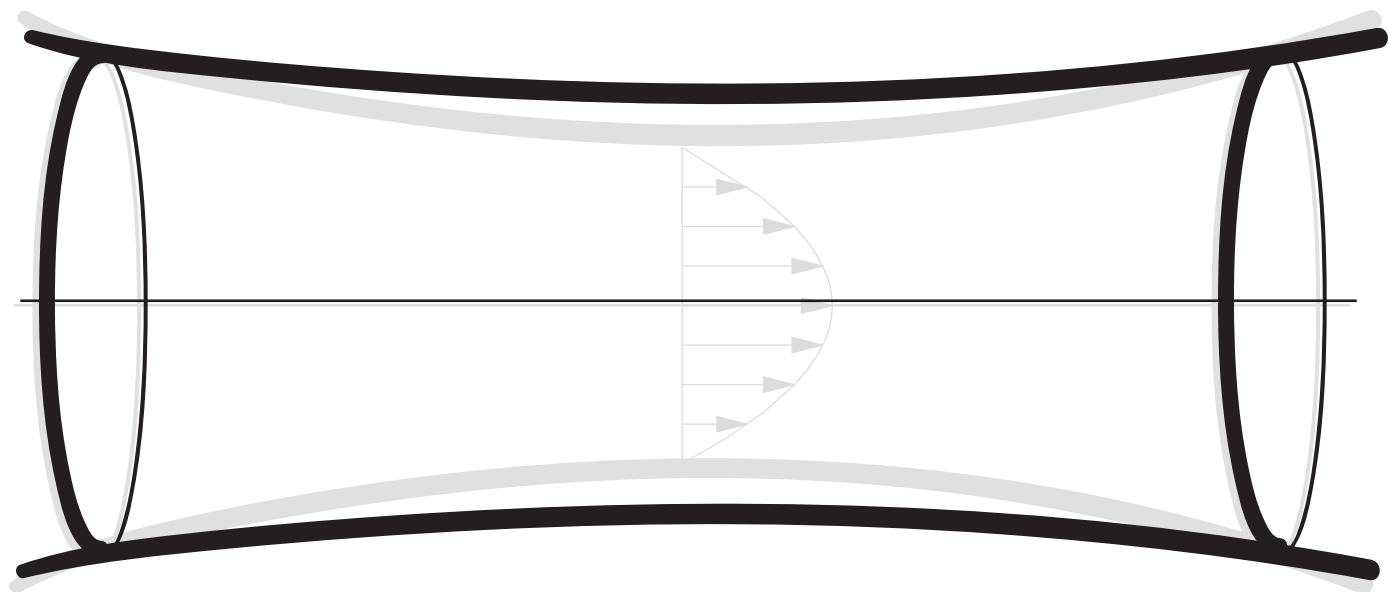

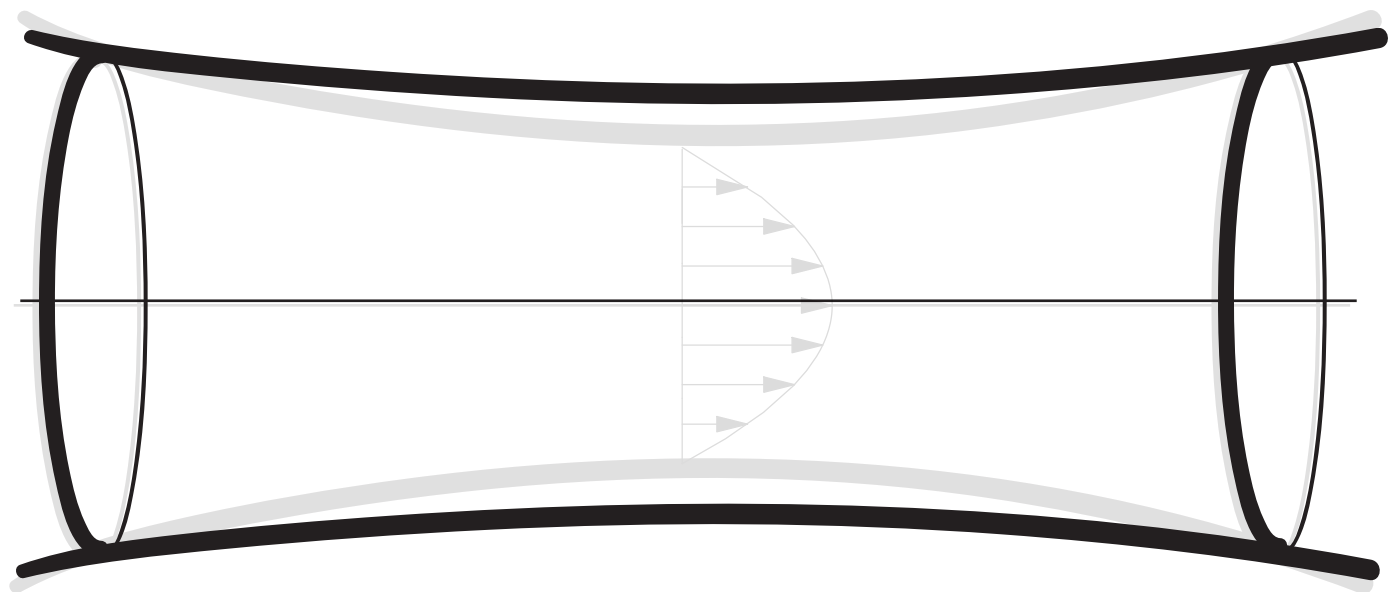

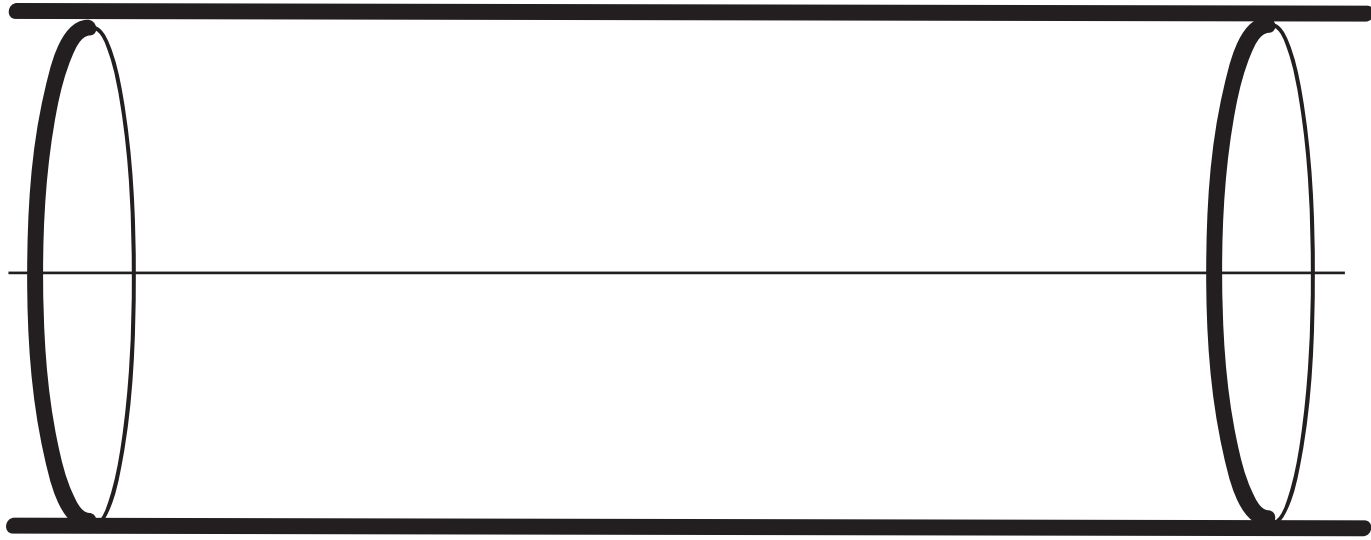

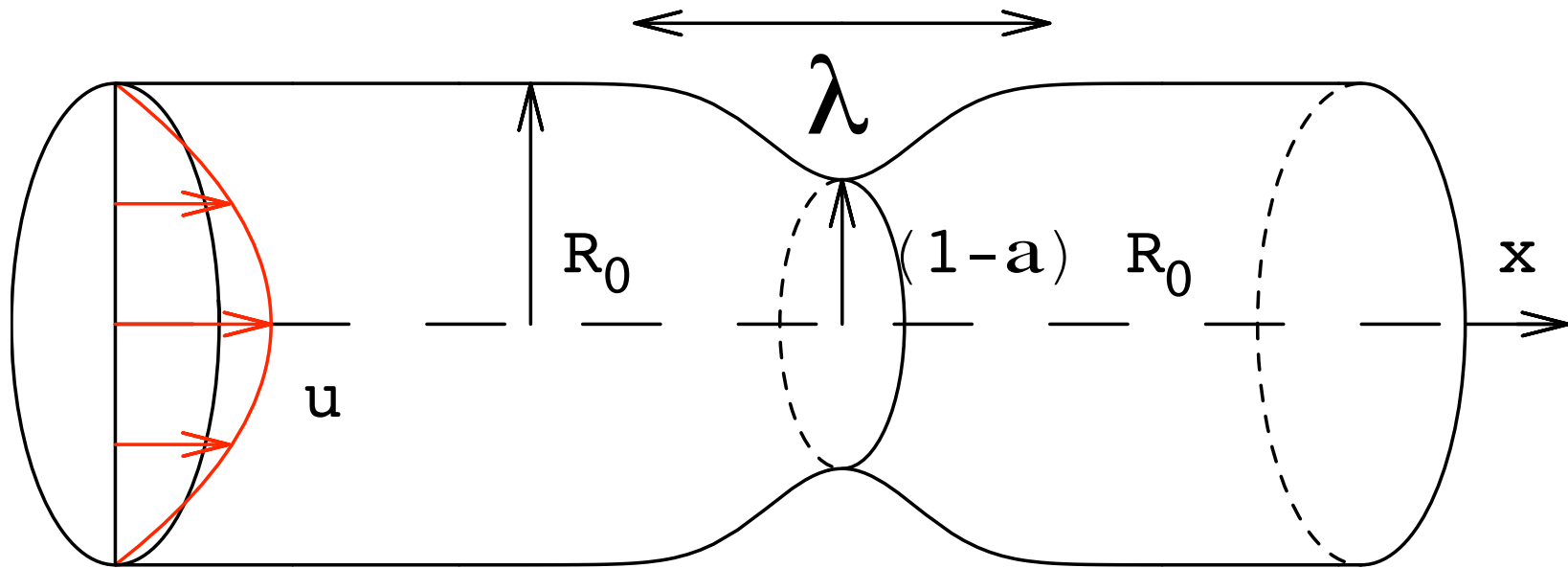

RNSP Scales

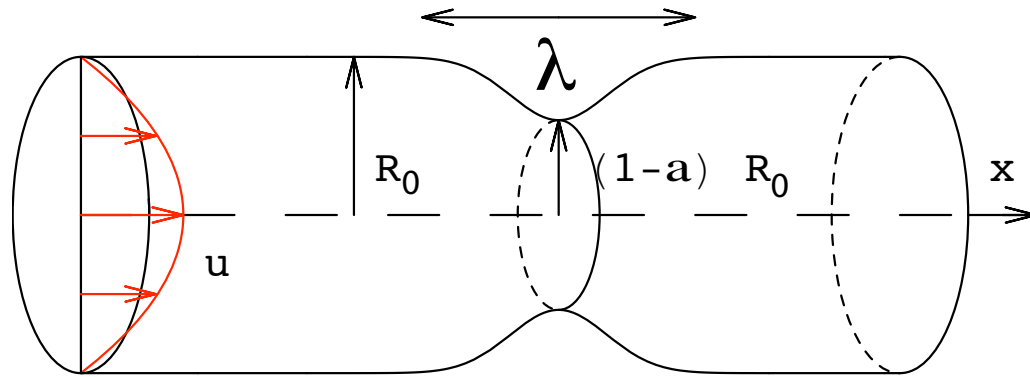

Using:

$$x^* = xR_0Re, \quad r^* = rR_0, \quad u^* = U_0u, \quad v^* = \frac{U_0}{Re}v,$$
$$p^* = p_0^* + \rho_0U_0^2p \quad \text{and} \quad \tau^* = \frac{\rho U_0^2}{Re}\tau$$

the following partial differential system is obtained from Navier Stokes as $Re \rightarrow \infty$:

RNSP: Reduced Navier Stokes/ Prandtl System

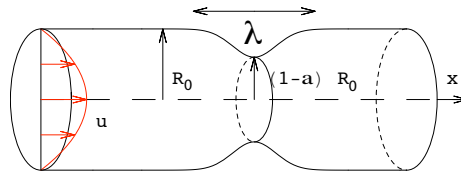

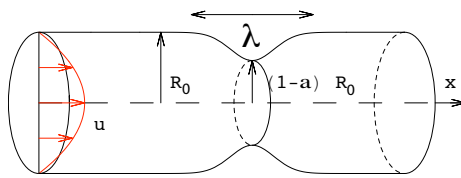

RNSP: Reduced Navier Stokes/ Prandtl System

$$\frac{\partial}{\partial x}u + \frac{\partial}{r\partial r}rv = 0,$$

$$\left(u\frac{\partial}{\partial x}u + v\frac{\partial}{\partial r}u\right) = -\frac{\partial p}{\partial x} + \frac{\partial}{r\partial r}\left(r\frac{\partial}{\partial r}u\right),$$

$$0 = -\frac{\partial p}{\partial r}.$$

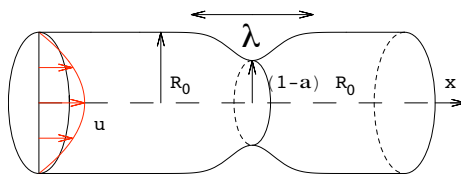

RNSP: Reduced Navier Stokes/ Prandtl System

$$\frac{\partial}{\partial x}u + \frac{\partial}{r\partial r}rv = 0,$$

$$\left(u\frac{\partial}{\partial x}u + v\frac{\partial}{\partial r}u\right) = -\frac{\partial p}{\partial x} + \frac{\partial}{r\partial r}\left(r\frac{\partial}{\partial r}u\right),$$

$$0 = -\frac{\partial p}{\partial r}.$$

+ The boundary conditions.

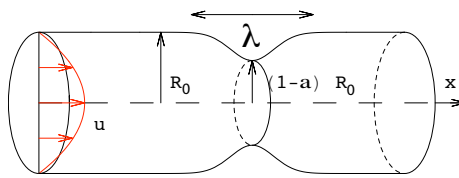

RNSP: Reduced Navier Stokes/ Prandtl System

$$\begin{aligned} \frac{\partial}{\partial x}u + \frac{\partial}{r\partial r}rv &= 0, \\ \left(u\frac{\partial}{\partial x}u + v\frac{\partial}{\partial r}u\right) &= -\frac{\partial p}{\partial x} + \frac{\partial}{r\partial r}\left(r\frac{\partial}{\partial r}u\right), \\ 0 &= -\frac{\partial p}{\partial r}. \end{aligned}$$

- axial symmetry ($\partial_r u = 0$ and $v = 0$ at $r = 0$),
- no slip condition at the wall ($u = v = 0$ at $r = 1 - f(x)$),
- the entry velocity profiles ($u(0, r)$ and $v(0, r)$) are given
- *no* output condition in $x_{out} = \frac{x_{out}^*}{R_0 Re}$
- streamwise marching, even when flow separation.

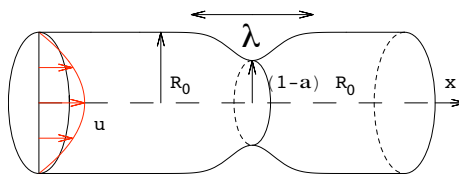

RNSP: Reduced Navier Stokes/ Prandtl System

$$\begin{aligned} \frac{\partial}{\partial x}u + \frac{\partial}{r\partial r}rv &= 0, \\ (u\frac{\partial}{\partial x}u + v\frac{\partial}{\partial r}u) &= -\frac{\partial p}{\partial x} + \frac{\partial}{r\partial r}(r\frac{\partial}{\partial r}u), \\ 0 &= -\frac{\partial p}{\partial r}. \end{aligned}$$

Parabolic Problem - Marching Problem

- axial symmetry ($\partial_r u = 0$ and $v = 0$ at $r = 0$),
- no slip condition at the wall ($u = v = 0$ at $r = 1 - f(x)$),
- the entry velocity profiles ($u(0, r)$ and $v(0, r)$) are given
- *no* output condition in $x_{out} = \frac{x_{out}^*}{R_0 Re}$
- streamwise marching, even when flow separation.

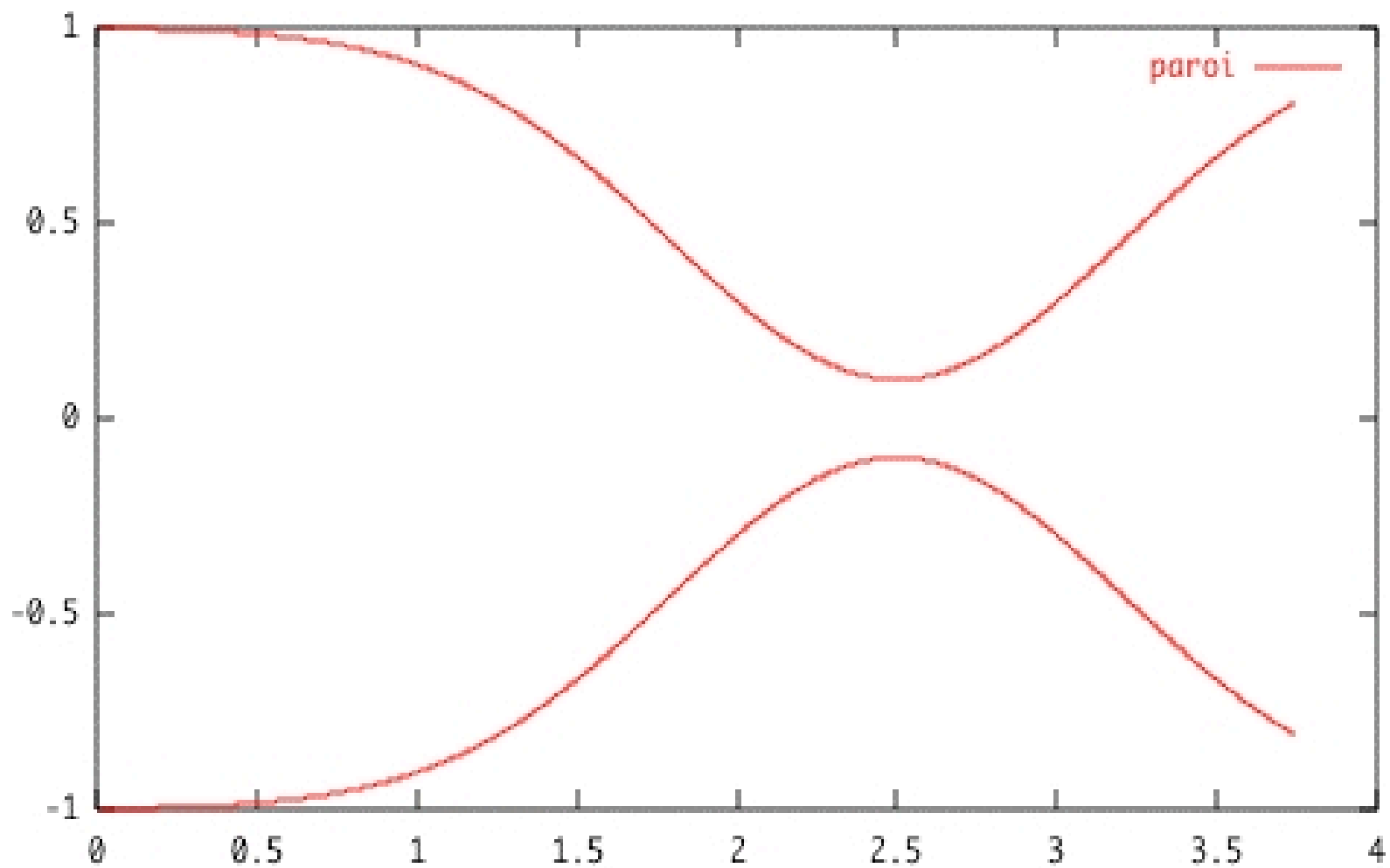
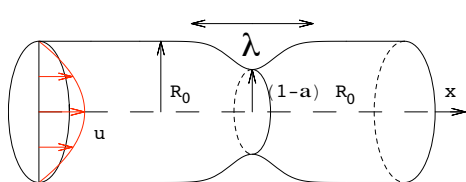

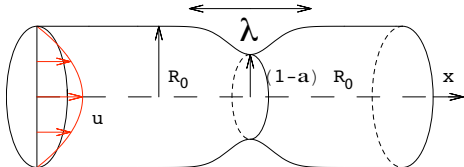

Evolution of the velocity profile along the convergent part of a 70% stenosis

($Re = 500$) ;

solid line: Poiseuille entry

broken line: flat entry

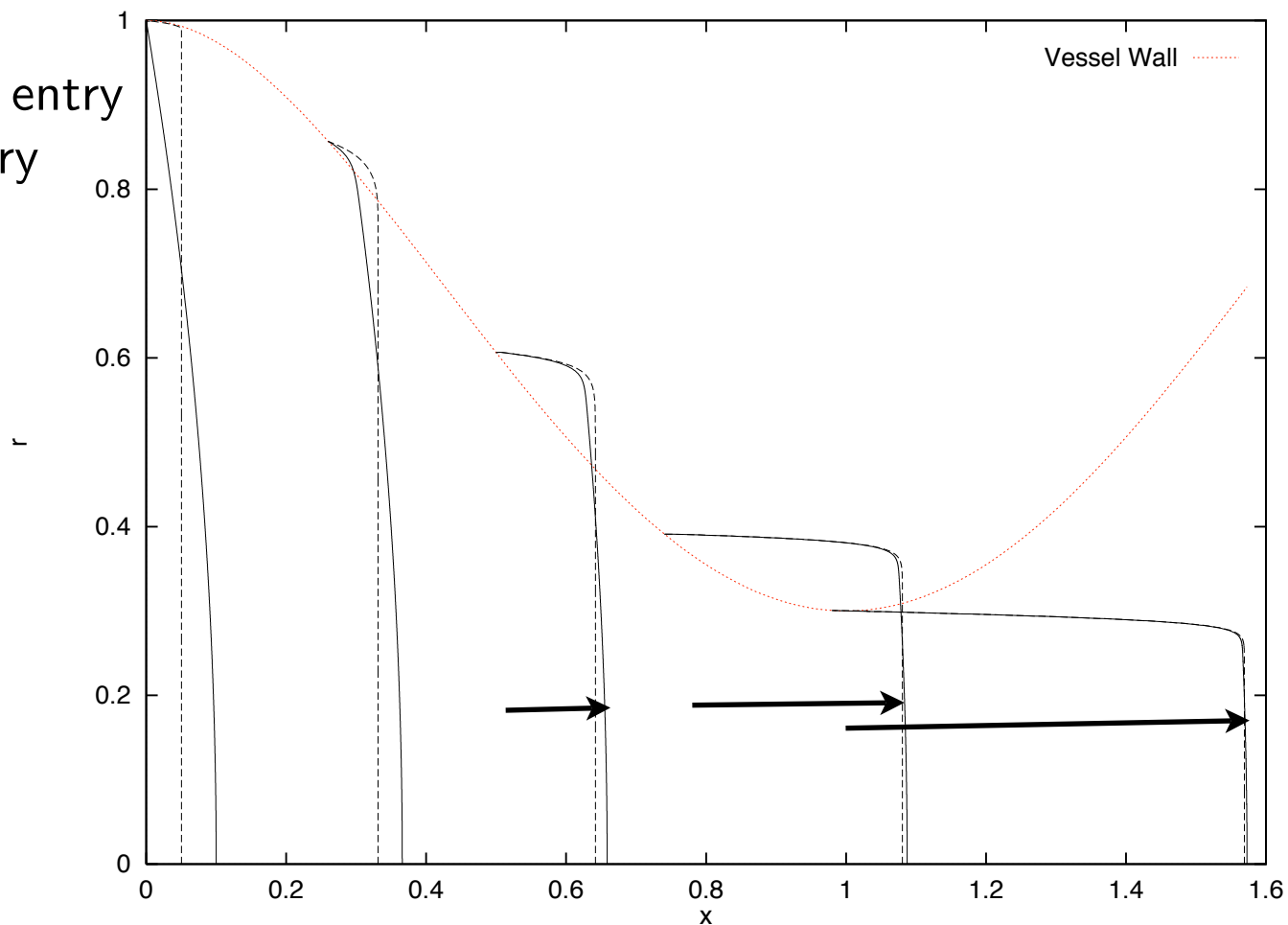

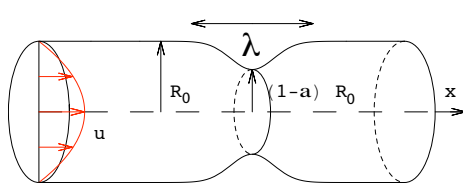

Testing asymmetry in the entry profile

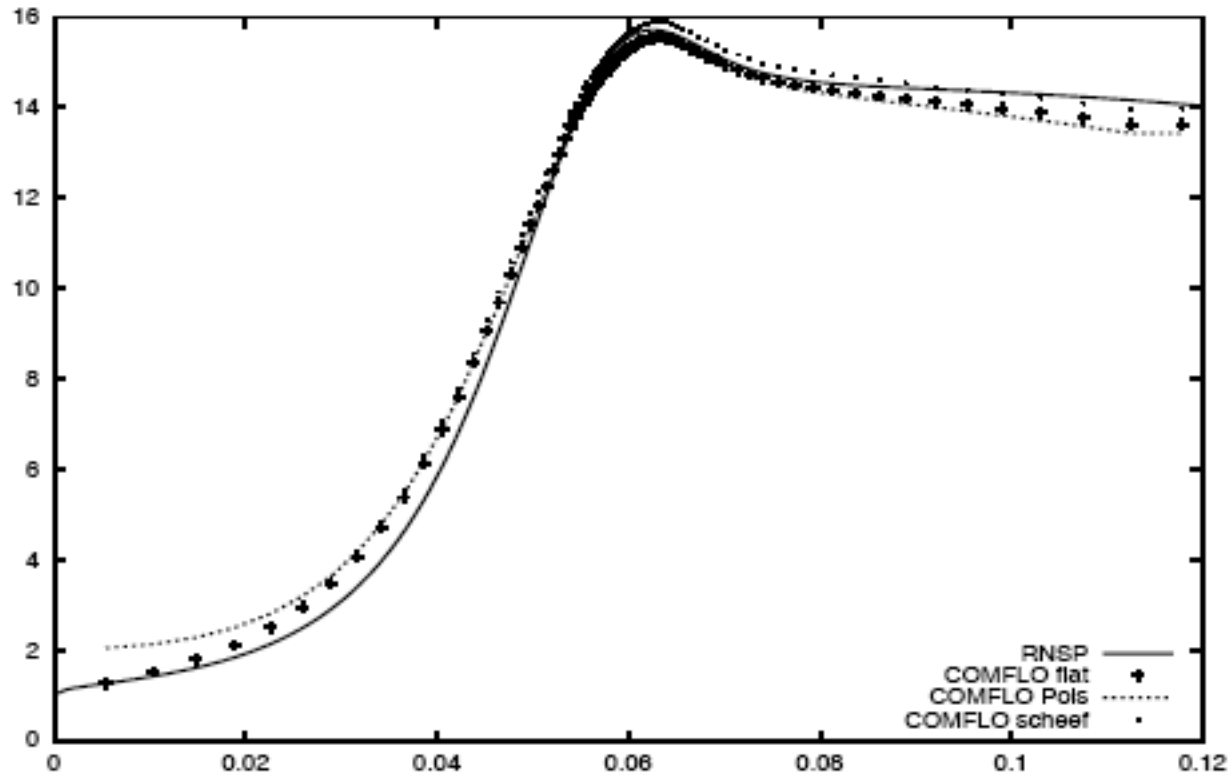

The velocities in the middle for Comflo and RNS.

Comflo uses here 50X50X100 points. Dimensionless scales!

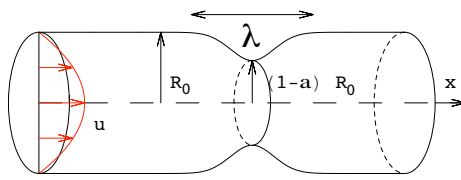

Wall Shear Stress

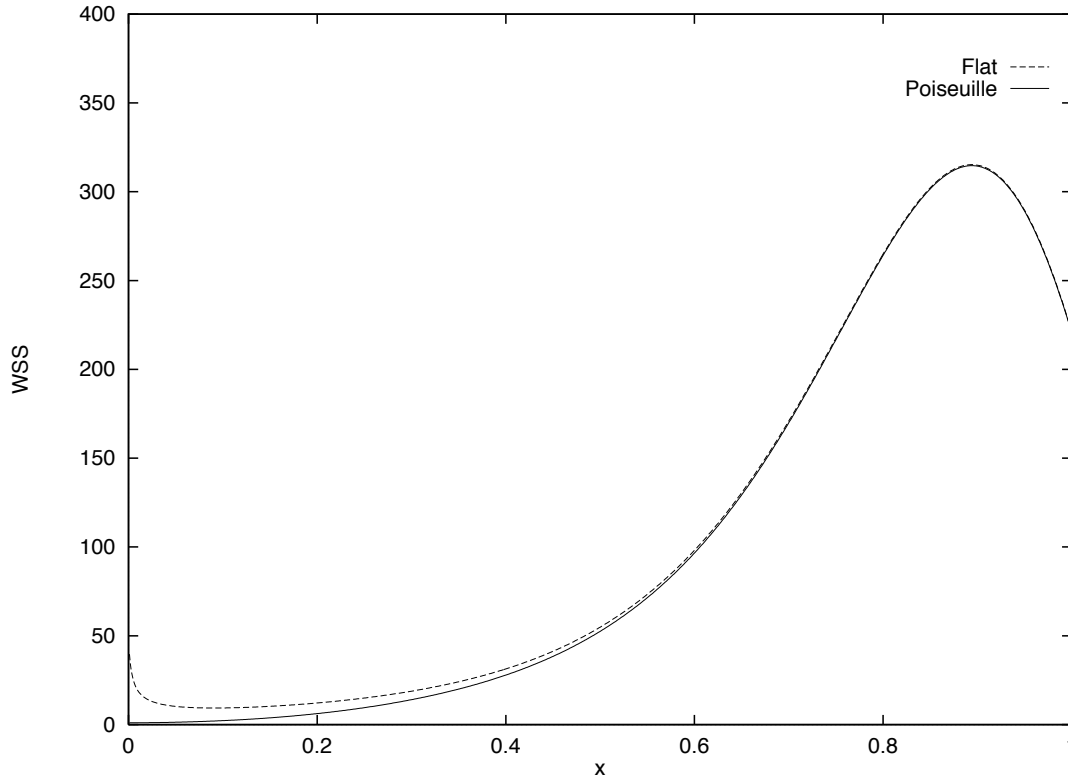

Evolution of the WSS distribution along the convergent part of a 70% stenosis ($Re = 500$) ; solid line: Poiseuille entry profile ; broken line: flat entry profile.

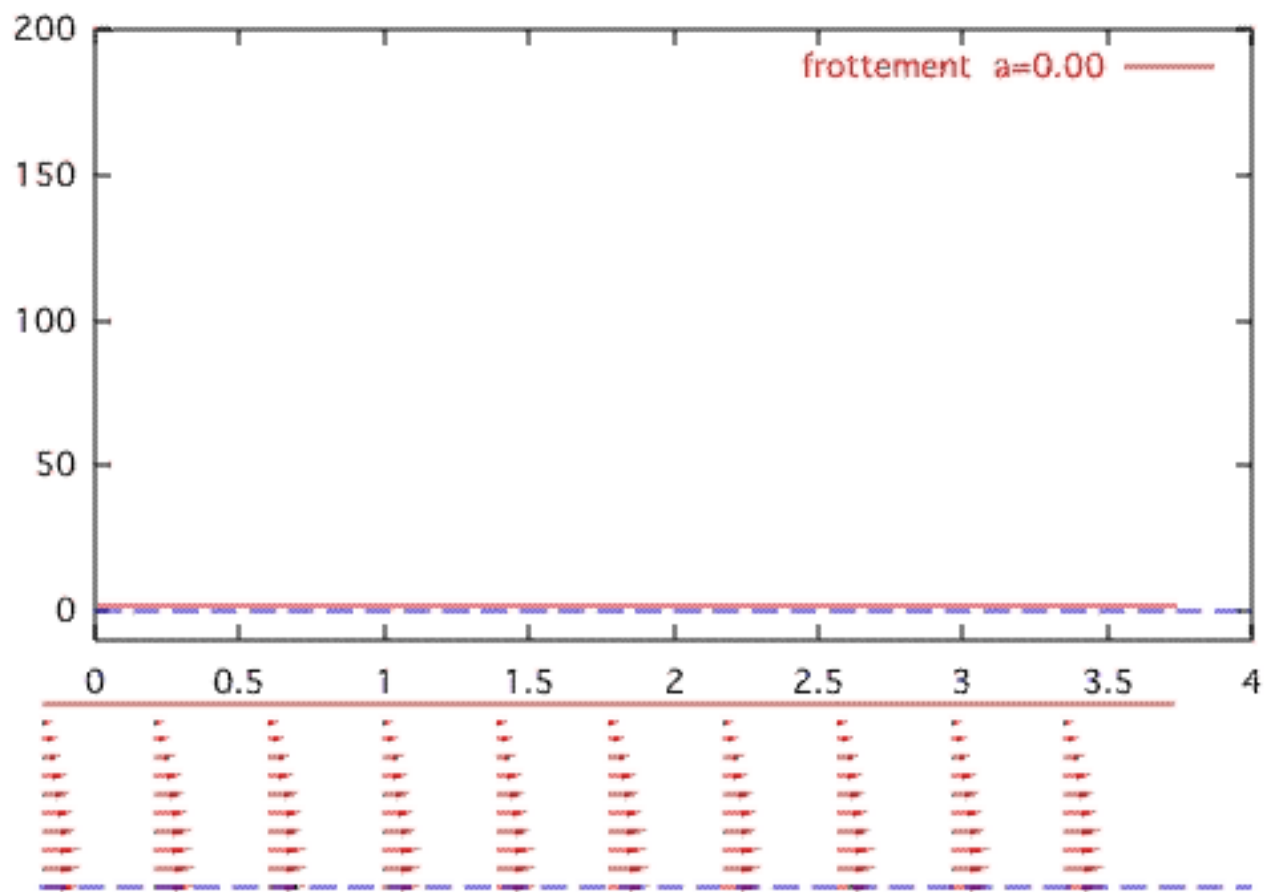
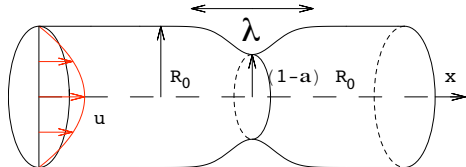

Boundary Layer / Perfect Fluid

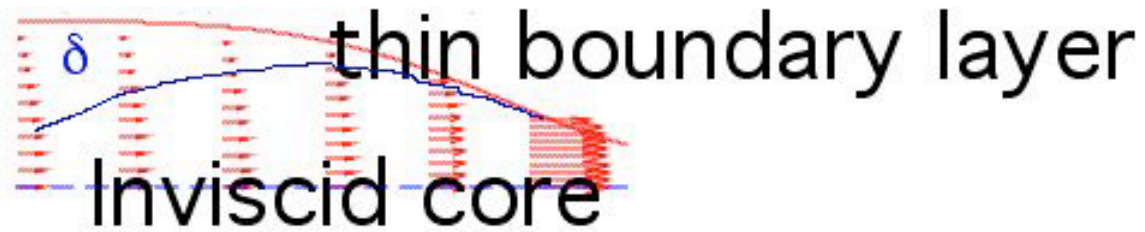
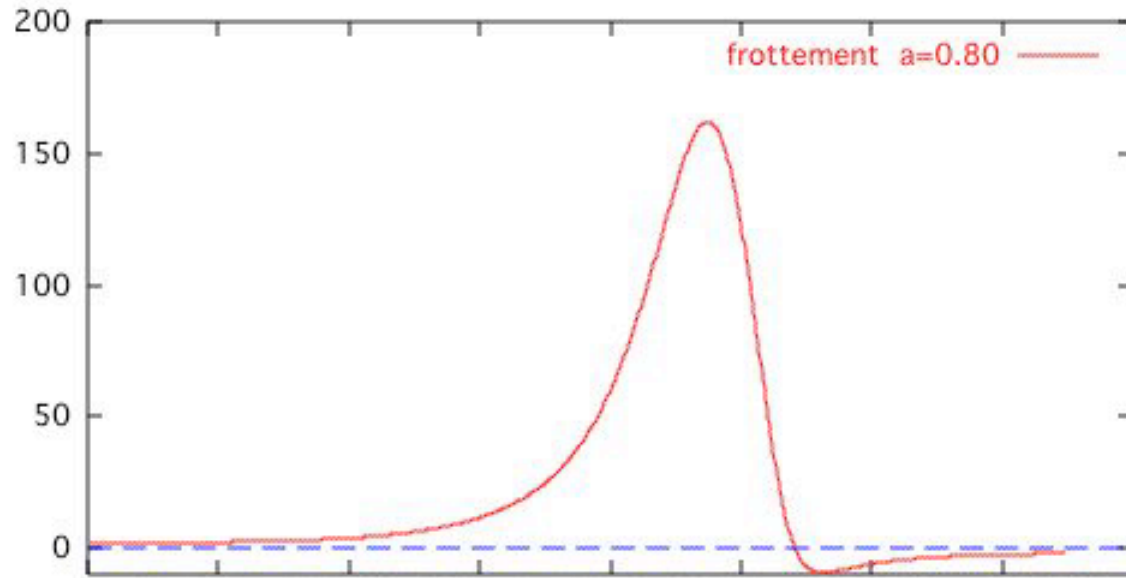
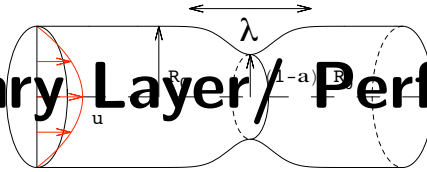

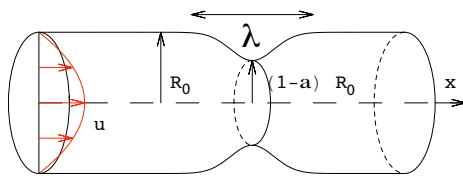

Boundary Layer/ Perfect Fluid

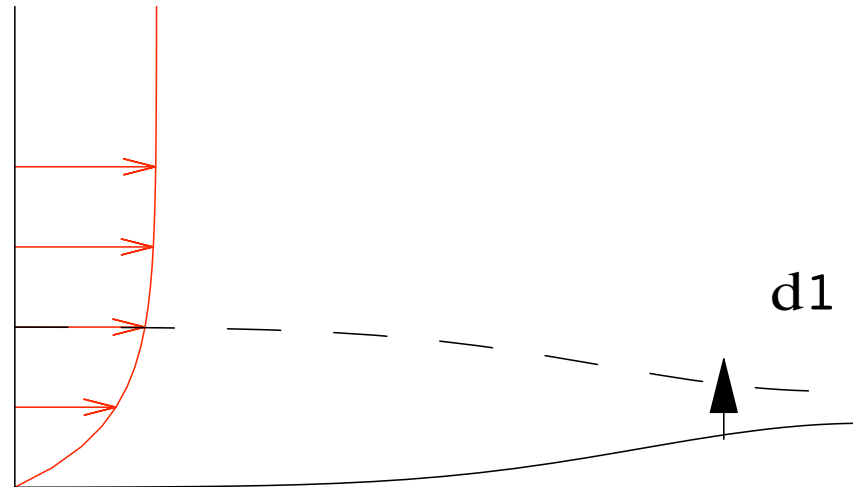

The boundary layer is generated near the wall
 δ_1 is the displacement thickness.

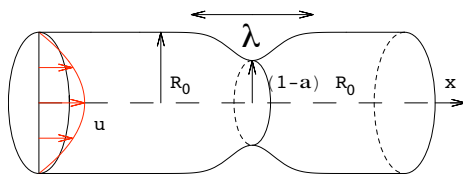

Boundary Layer/ Perfect Fluid

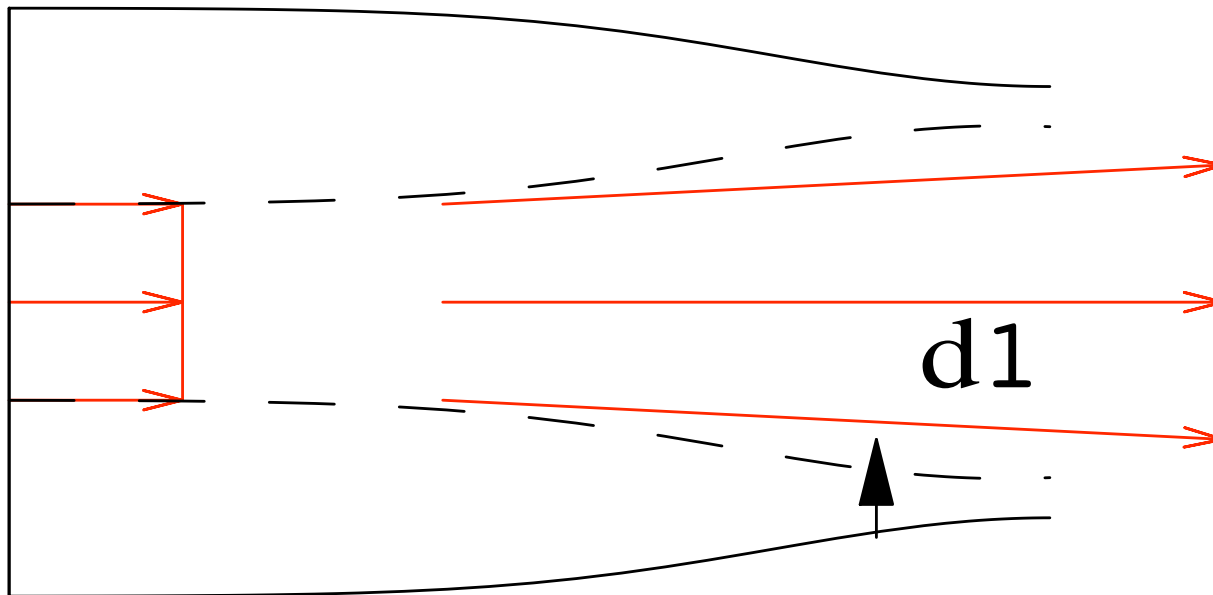

The displacement thickness acts as a "new" wall!
 → Interacting Boundary Layer (IBL)

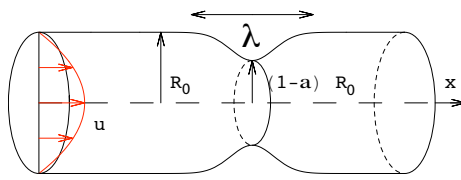

RNSP/ IBL

After rescaling:

$r = R(\bar{x}) - (\lambda/Re)^{-1/2}\bar{y}$, $u = \bar{u}$, $v = (\lambda/Re)^{1/2}\bar{v}$ and $x - x_b = (\lambda/Re)\bar{x}$, $p = \bar{p}$, where x_b is the position of the bump, the RNSP(x) set gives the final IBL (interacting Boundary Layer) problem as follows:

$$\frac{\partial \bar{u}}{\partial \bar{x}} + \frac{\partial \bar{v}}{\partial \bar{n}} = 0$$

$$\left(\bar{u} \frac{\partial \bar{u}}{\partial \bar{x}} + \bar{v} \frac{\partial \bar{u}}{\partial \bar{n}} \right) = \bar{u}_e \frac{d\bar{u}_e}{d\bar{s}} + \frac{\partial}{\partial \bar{n}} \frac{\partial \bar{u}}{\partial \bar{n}}$$

with: $\bar{u}(\bar{x}, 0) = 0$, $\bar{v}(\bar{x}, 0) = 0$, $\bar{u}(\bar{x}, \infty) = u_e$, where $\bar{\delta}_1 = \int_0^\infty \left(1 - \frac{\bar{u}}{u_e}\right) d\bar{n}$, and

$$\bar{u}_e = \frac{1}{(R^2 - 2((\lambda/Re)^{-1/2})\bar{\delta}_1)}.$$

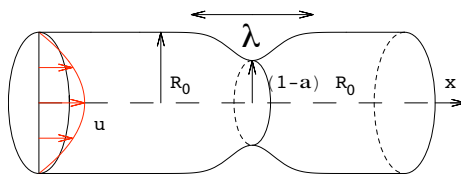

IBL integral: 1D equation

$$\frac{d}{d\bar{x}}\left(\frac{\bar{\delta}_1}{H}\right) = \bar{\delta}_1\left(1 + \frac{2}{H}\right)\frac{d\bar{u}_e}{d\bar{x}} + \frac{f_2 H}{\bar{\delta}_1 \bar{u}_e},$$

$$\bar{u}_e = \frac{1}{(R^2 - 2(\lambda/Re)^{-1/2}\bar{\delta}_1)}.$$

To solve this system, a closure relationship linking H and f_2 to the velocity and the displacement thickness is needed.

Defining $\Lambda_1 = \bar{\delta}_1^2 \frac{d\bar{u}_e}{d\bar{x}}$,

the system is closed from the resolution of the Falkner Skan system as follows:

if $\Lambda_1 < 0.6$ then $H = 2.5905 \exp(-0.37098\Lambda_1)$, else $H = 2.074$.

From H , f_2 is computed as $f_2 = 1.05(-H^{-1} + 4H^{-2})$.

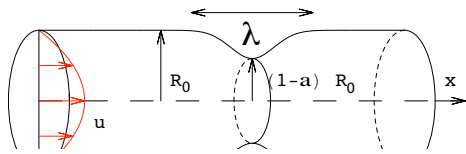

IBL integral: 1D equation Simplified Shear Stress

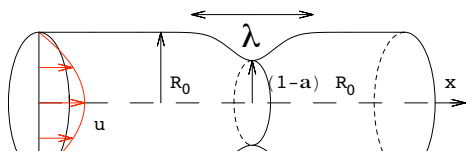

IBL integral: 1D equation Simplified Shear Stress

- variation of velocity (flux conservation)

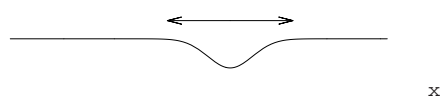

IBL integral: 1D equation Simplified Shear Stress

- variation of velocity (flux conservation) $U_0 \rightarrow U_0 / (1 - \alpha - \delta_1)^2$

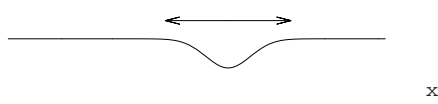

IBL integral: 1D equation Simplified Shear Stress

- variation of velocity (flux conservation) $U_0 \rightarrow U_0/(1 - \alpha - \delta_1)^2$

- acceleration: boundary layer $\delta_1 \simeq \frac{\lambda}{\sqrt{Re_\lambda}}$,

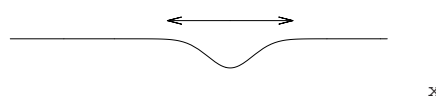

IBL integral: 1D equation Simplified Shear Stress

- variation of velocity (flux conservation) $U_0 \rightarrow U_0 / (1 - \alpha - \delta_1)^2$

- acceleration: boundary layer $\delta_1 \simeq \frac{\lambda}{\sqrt{Re_\lambda}}$, with $Re_\lambda = \frac{\lambda U_0}{(1 - \alpha)^2 \nu} = \frac{Re \lambda}{(1 - \alpha)^2}$

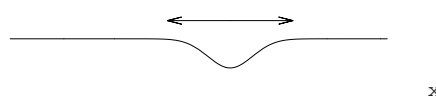

IBL integral: 1D equation Simplified Shear Stress

- variation of velocity (flux conservation) $U_0 \rightarrow U_0/(1 - \alpha - \delta_1)^2$
- acceleration: boundary layer $\delta_1 \simeq \frac{\lambda}{\sqrt{Re_\lambda}}$, with $Re_\lambda = \frac{\lambda U_0}{(1-\alpha)^2 \nu} = \frac{Re \lambda}{(1-\alpha)^2}$
- WSS = (variation of velocity)/(boundary layer thickness)

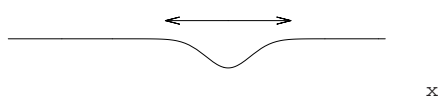

IBL integral: 1D equation Simplified Shear Stress

- variation of velocity (flux conservation) $U_0 \rightarrow U_0/(1 - \alpha - \delta_1)^2$
- acceleration: boundary layer $\delta_1 \simeq \frac{\lambda}{\sqrt{Re_\lambda}}$, with $Re_\lambda = \frac{\lambda U_0}{(1-\alpha)^2 \nu} = \frac{Re \lambda}{(1-\alpha)^2}$
- WSS = (variation of velocity)/(boundary layer thickness) = $\frac{(Re/\lambda)^{1/2}}{(1-\alpha)^3}$

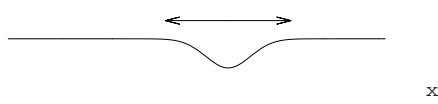

IBL integral: 1D equation Simplified Shear Stress

- variation of velocity (flux conservation) $U_0 \rightarrow U_0/(1 - \alpha - \delta_1)^2$
- acceleration: boundary layer $\delta_1 \simeq \frac{\lambda}{\sqrt{Re_\lambda}}$, with $Re_\lambda = \frac{\lambda U_0}{(1-\alpha)^2 \nu} = \frac{Re \lambda}{(1-\alpha)^2}$
- WSS = (variation of velocity)/(boundary layer thickness) = $\frac{(Re/\lambda)^{1/2}}{(1-\alpha)^3}$

A simple formula as been settled:

$$WSS = \left(\mu \frac{\partial u^*}{\partial y^*} \right) / \left(\mu \frac{4U_0}{R} \right) \sim .22 \frac{((Re/\lambda)^{1/2} + 3)}{(1 - \alpha)^3}$$

Reynolds number is no longer Re but $Re\lambda$ and $(Re/\lambda)^{1/2}$ is the inverse of the relative boundary layer thickness.

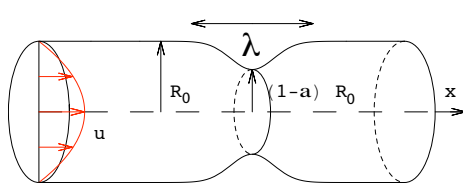

IBL integral: Comparison with Navier Stokes (Siegel et al. 1994)

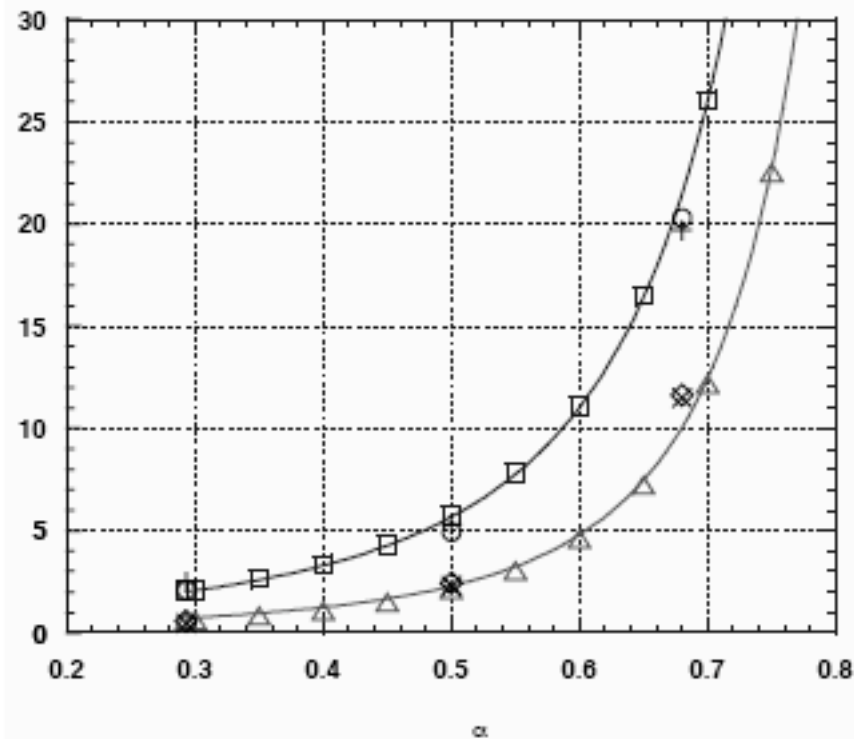

$$WSS = aRe^{1/2} + b$$

Coefficient a and b for the maximum WSS.
 solid lines with \triangle and "square" : coefficient a and b obtained using the IBL integral method ;

- \diamond : coefficient a derived from Siegel for $\lambda = 3$;
- \times : coefficient a derived from Siegel for $\lambda = 6$;
- \circ : coefficient b derived from Siegel for $\lambda = 3$;
- $+$: coefficient b derived from Siegel for $\lambda = 6$.

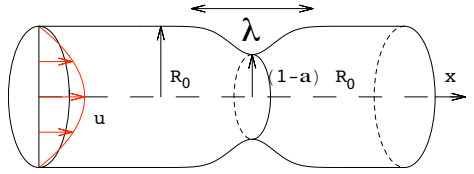

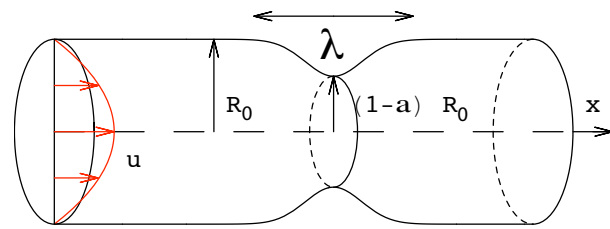

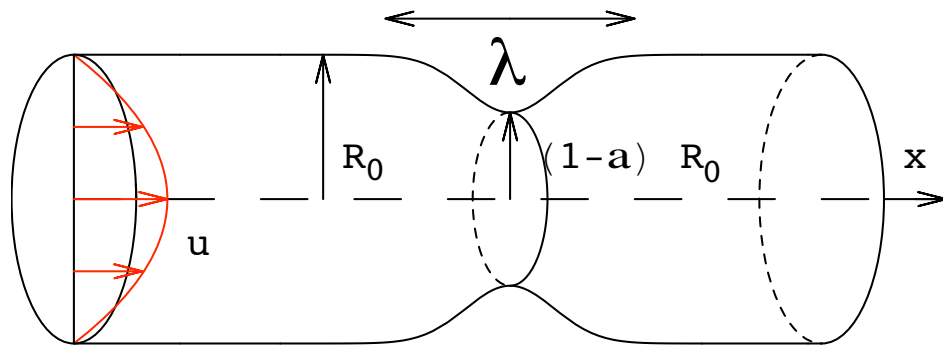

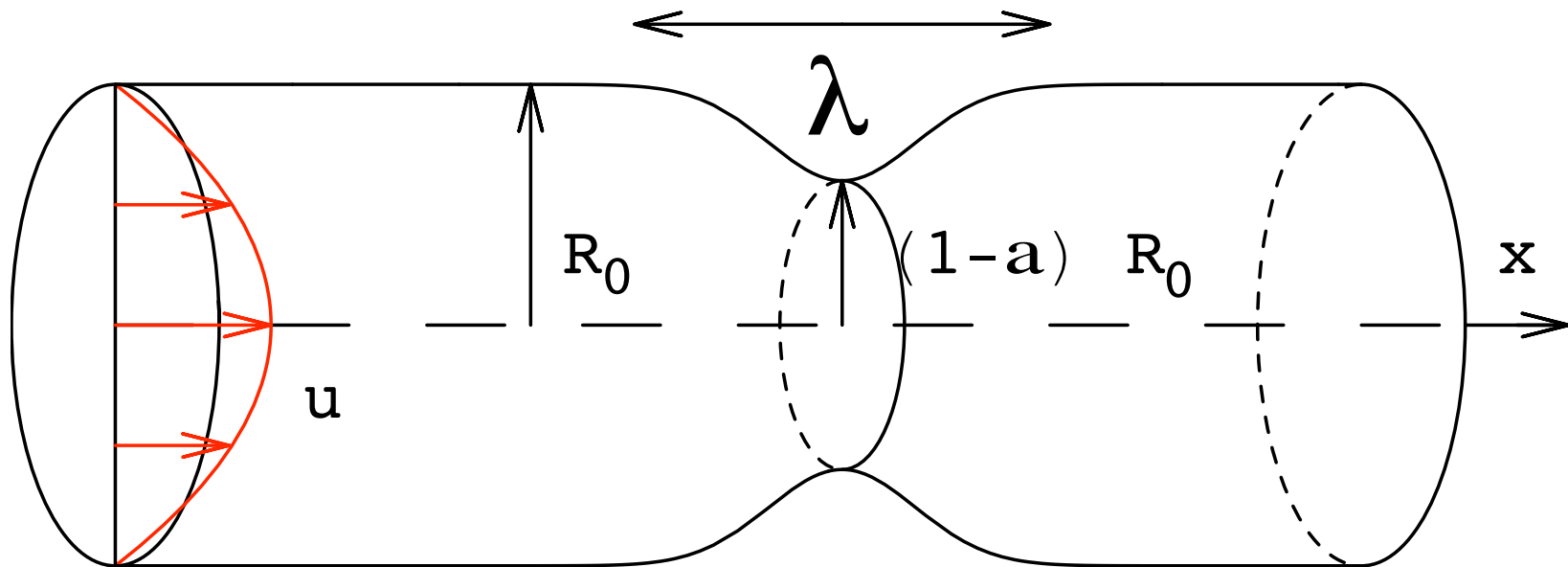



Example 2

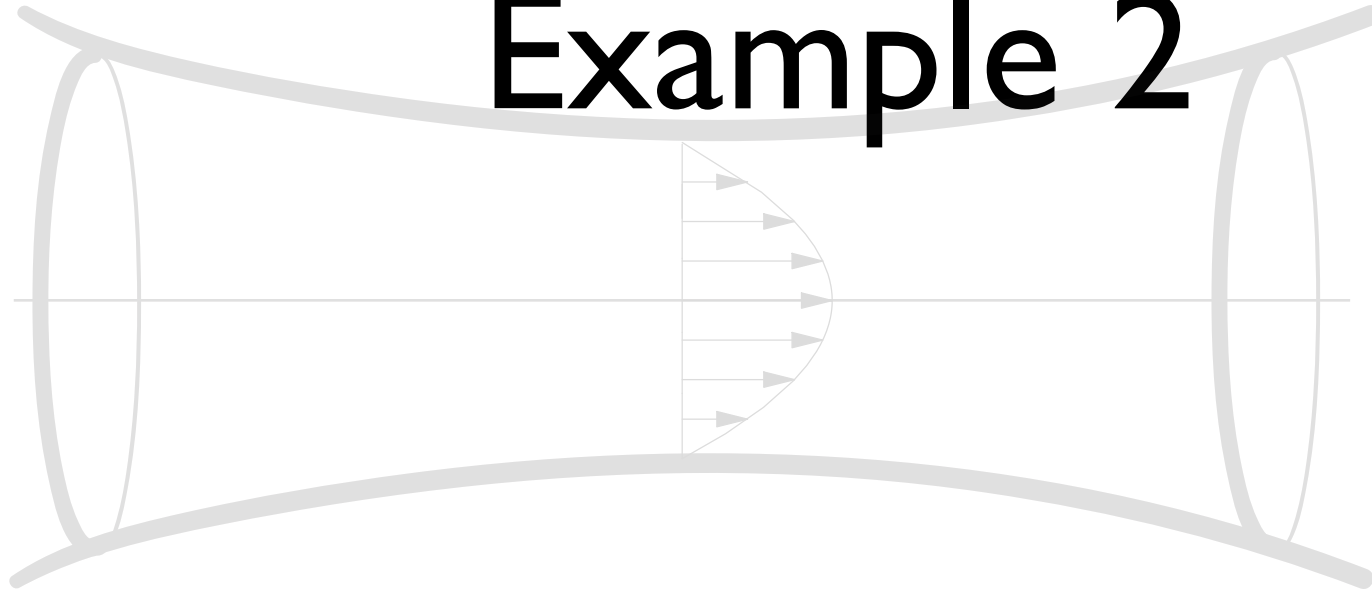

- Flow in a 2D stenosed vessel
- steady, rigid wall

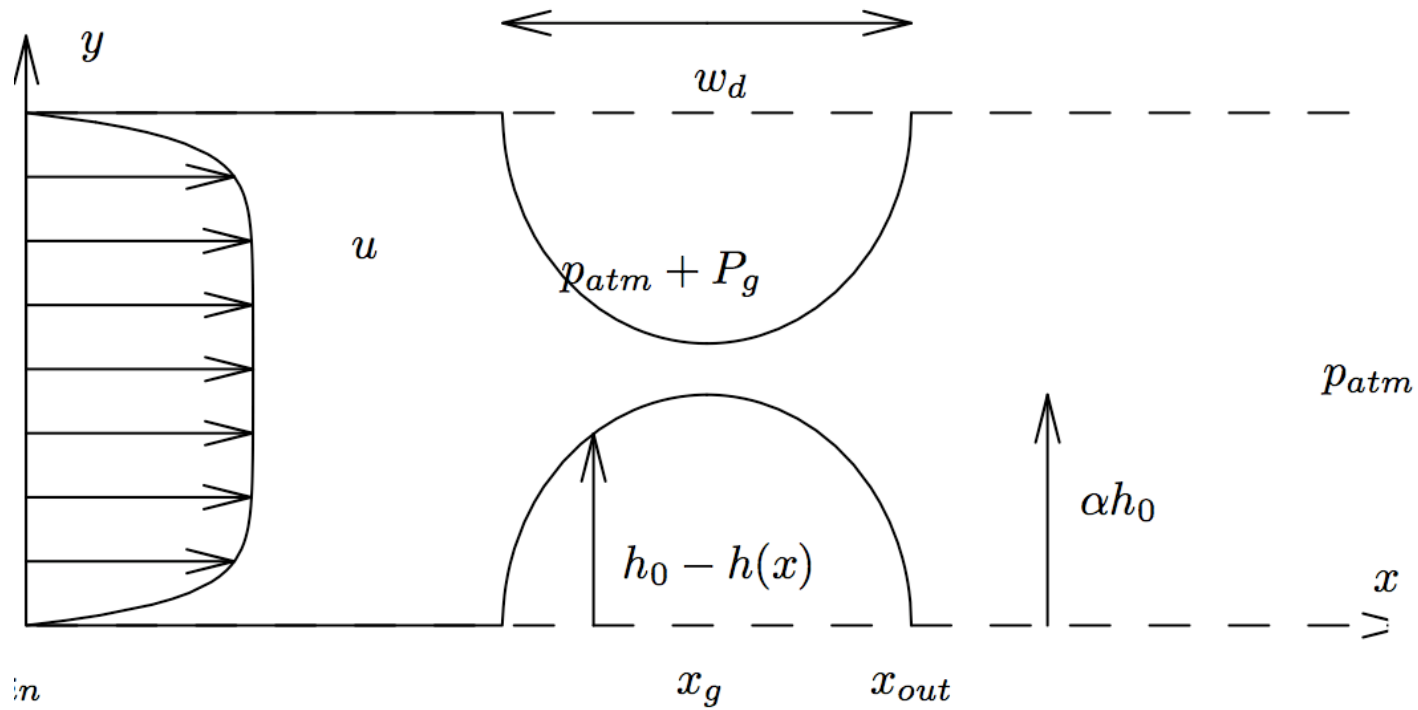

- Flow in a stenosed vessel
- steady, rigid wall

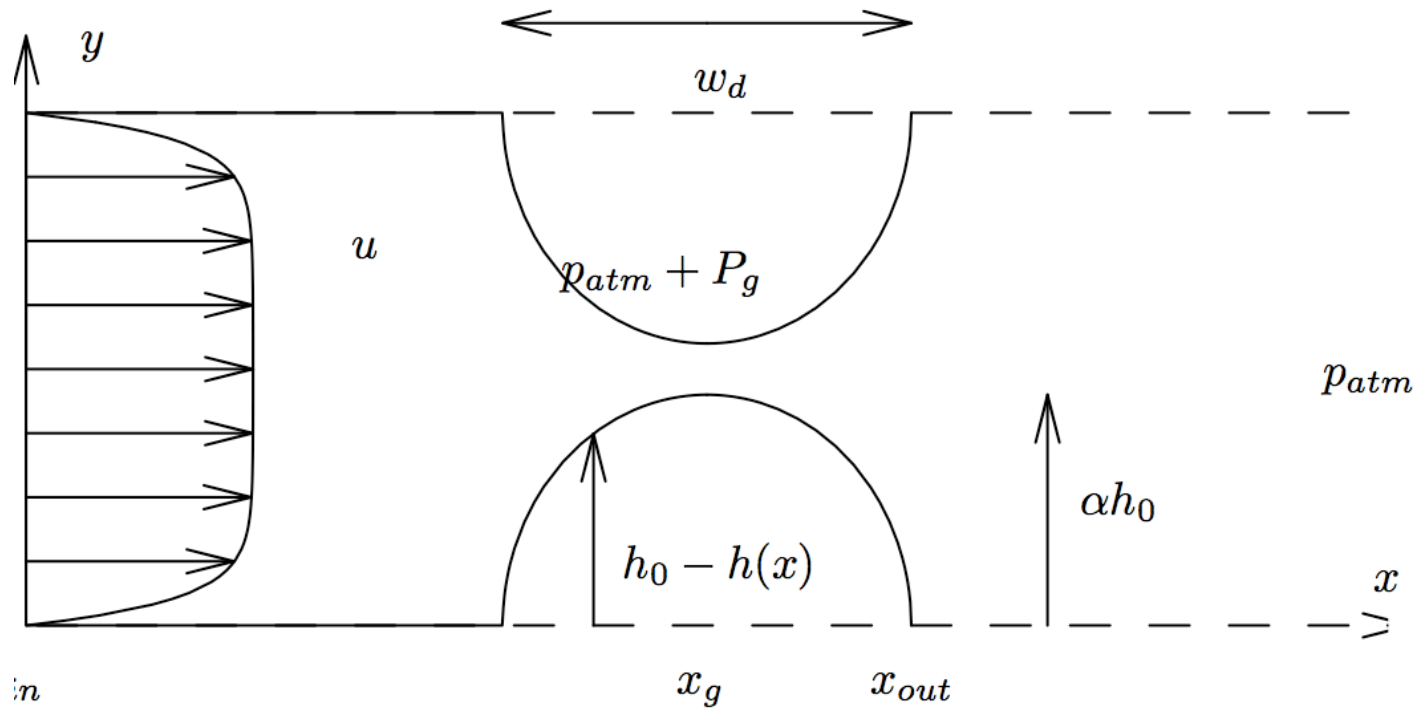

$$\frac{\partial}{\partial x}u + \frac{\partial}{\partial y}v = 0$$

$$u \frac{\partial}{\partial x}u + v \frac{\partial}{\partial y}u = -\frac{\partial}{\partial x}p + \frac{\partial^2}{\partial y^2}u$$

$$0 = -\frac{\partial}{\partial y}p$$

RNSP non dimensional

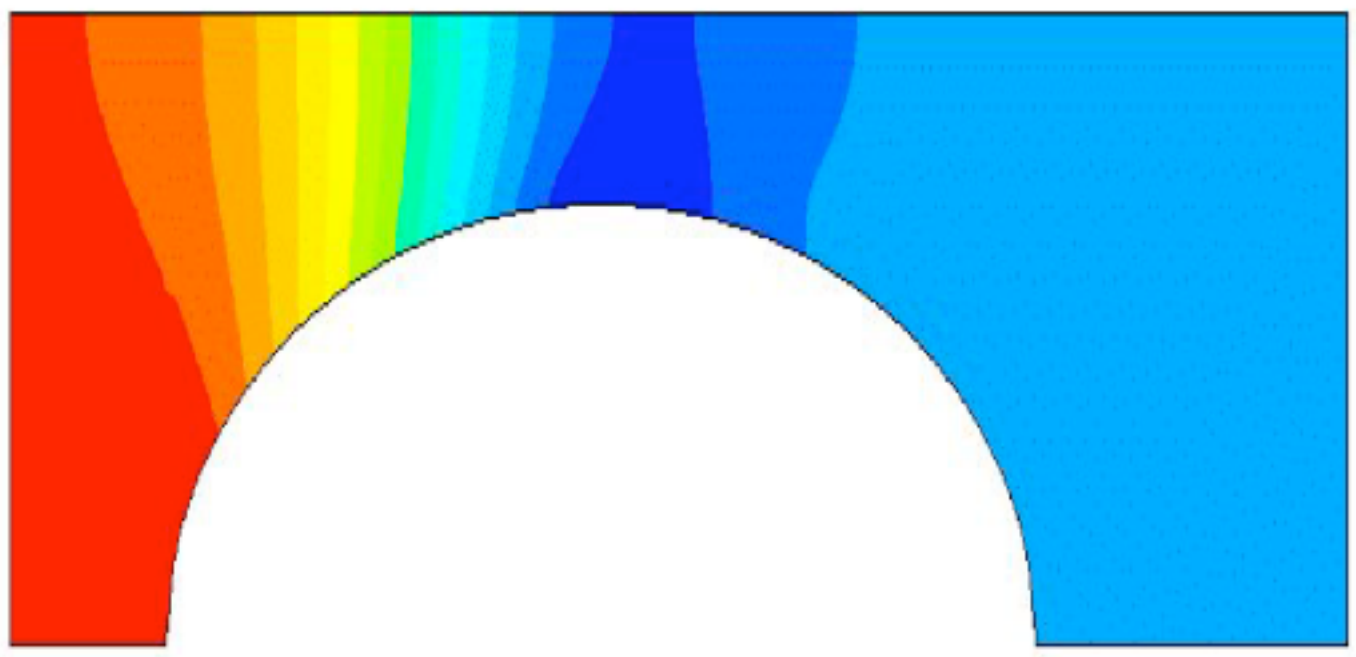
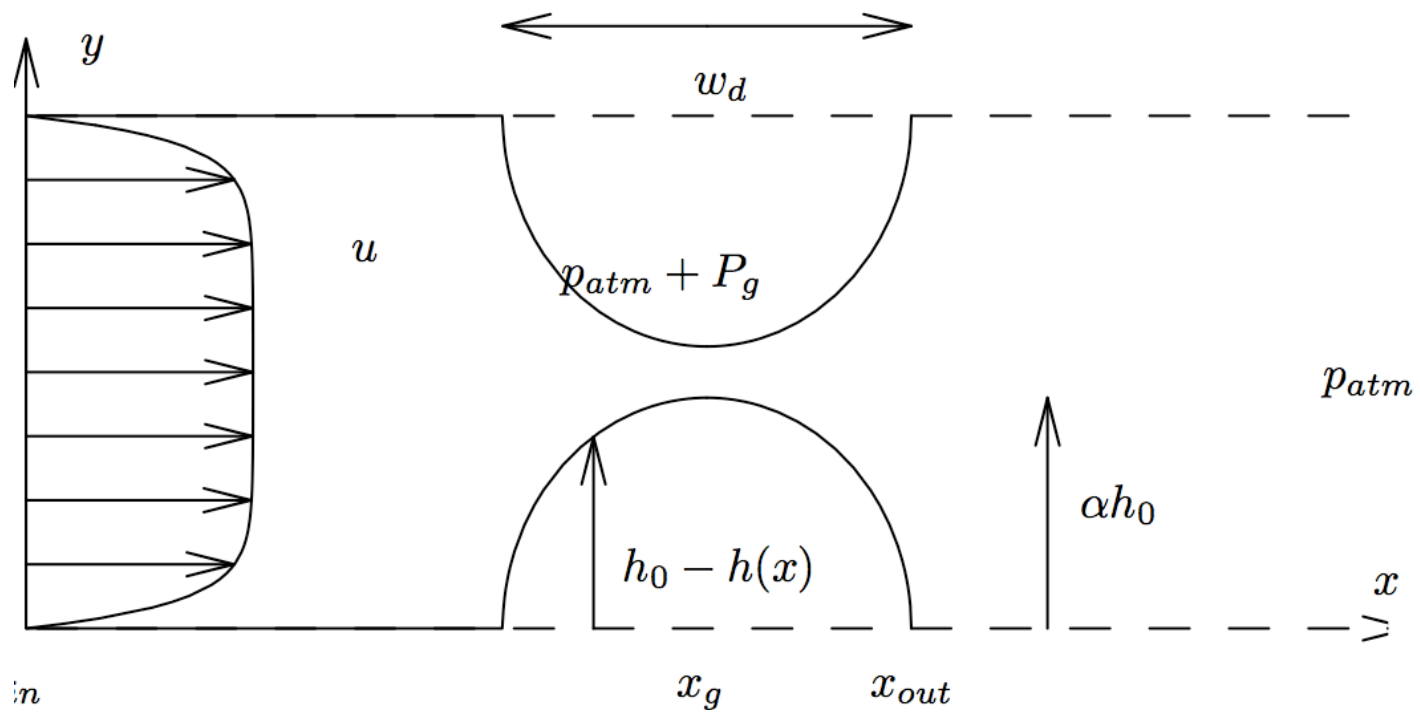

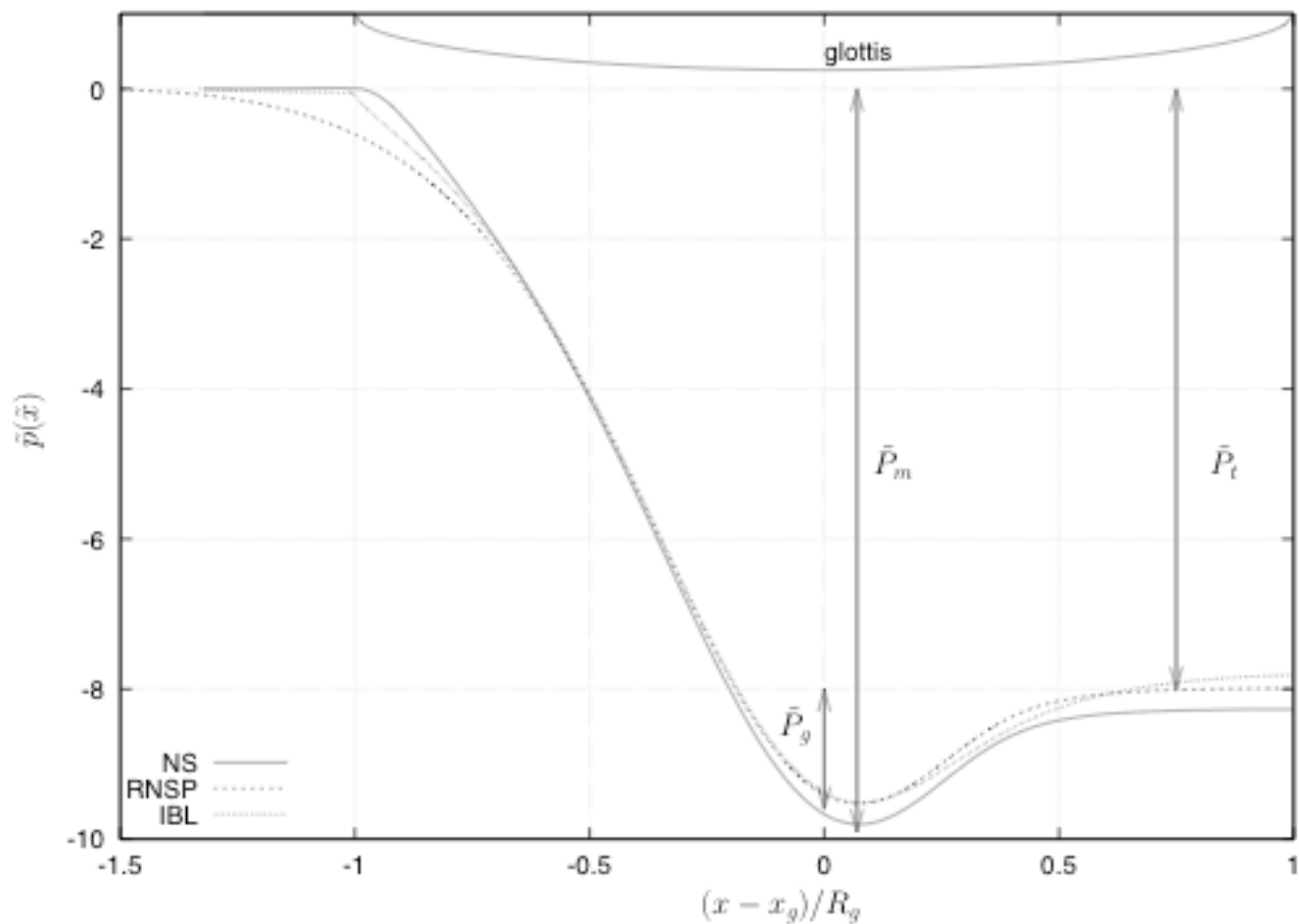
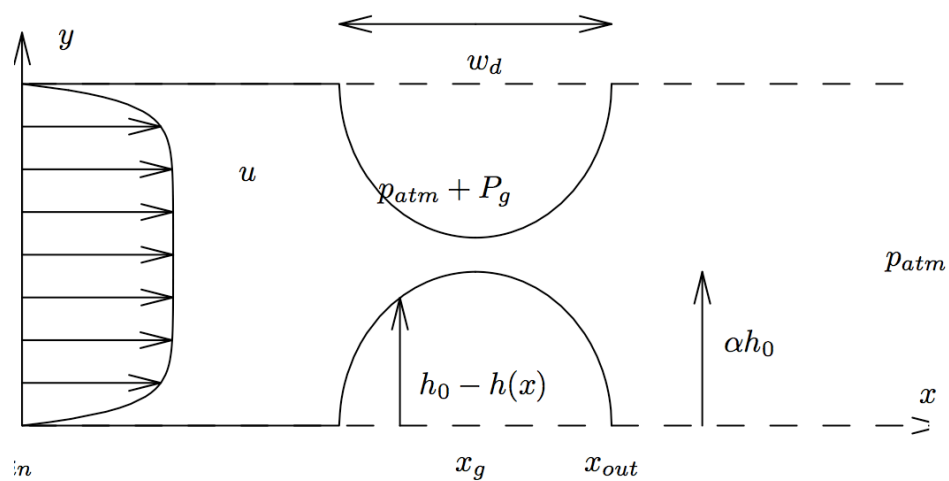

Fig. 2 A comparison between computed non-dimensional pressure for the three models (NS, IBL and RNSP, in this last case the wall has

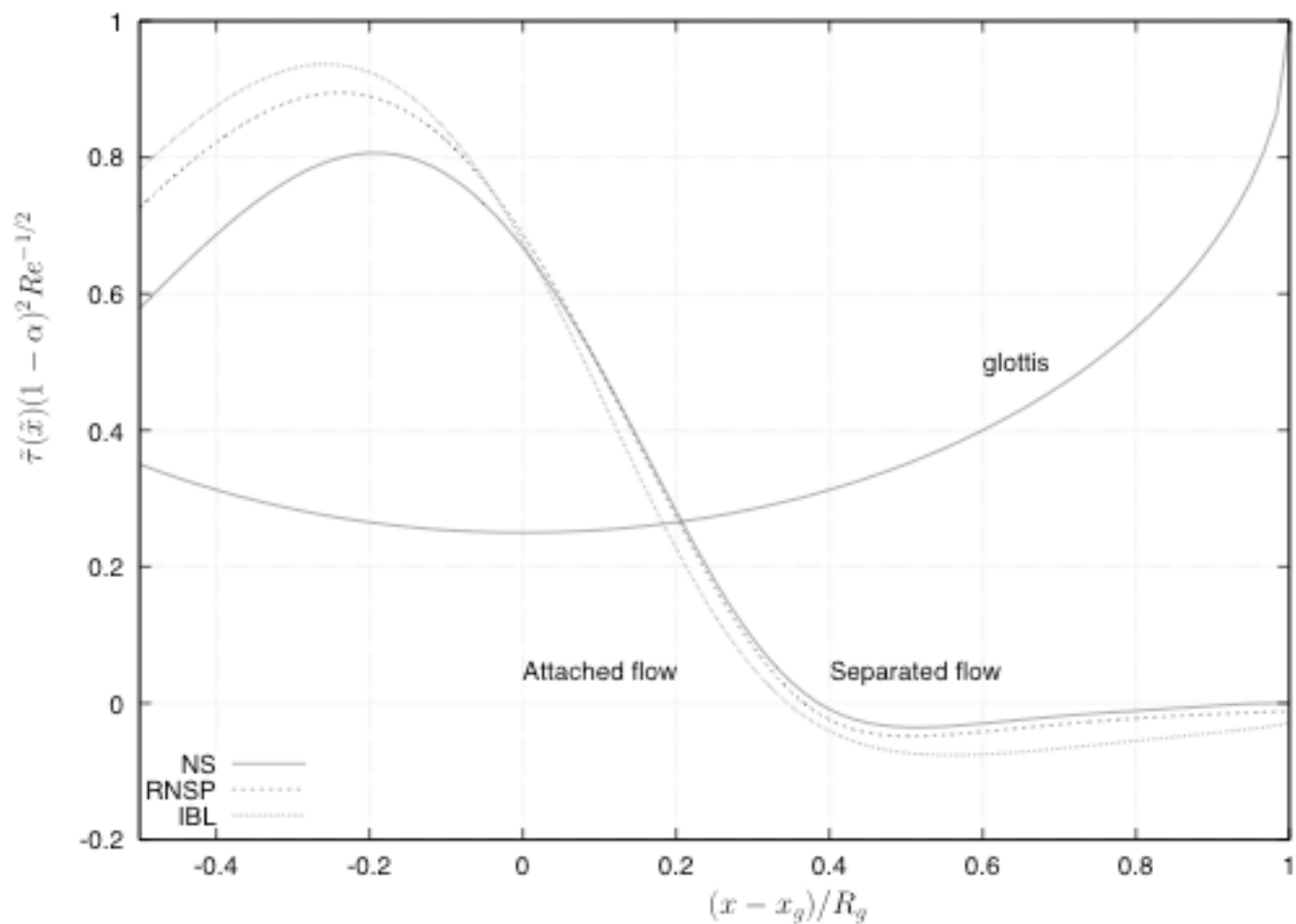
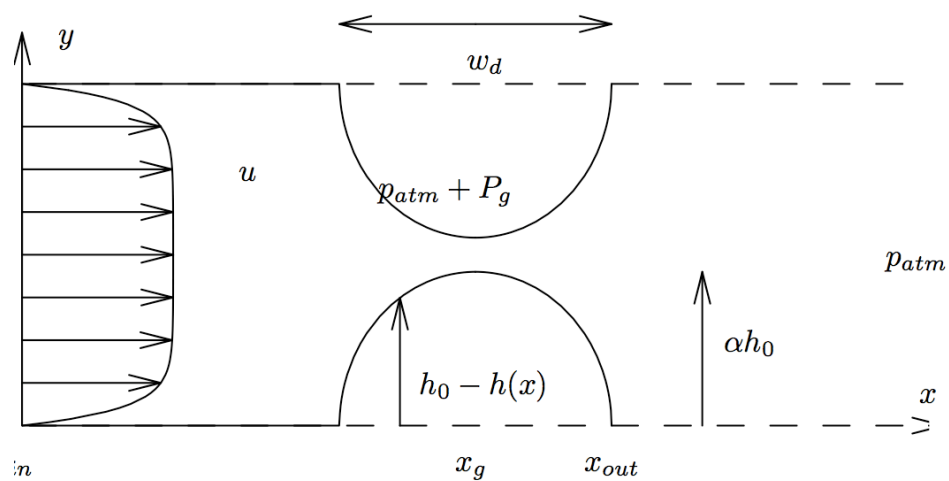
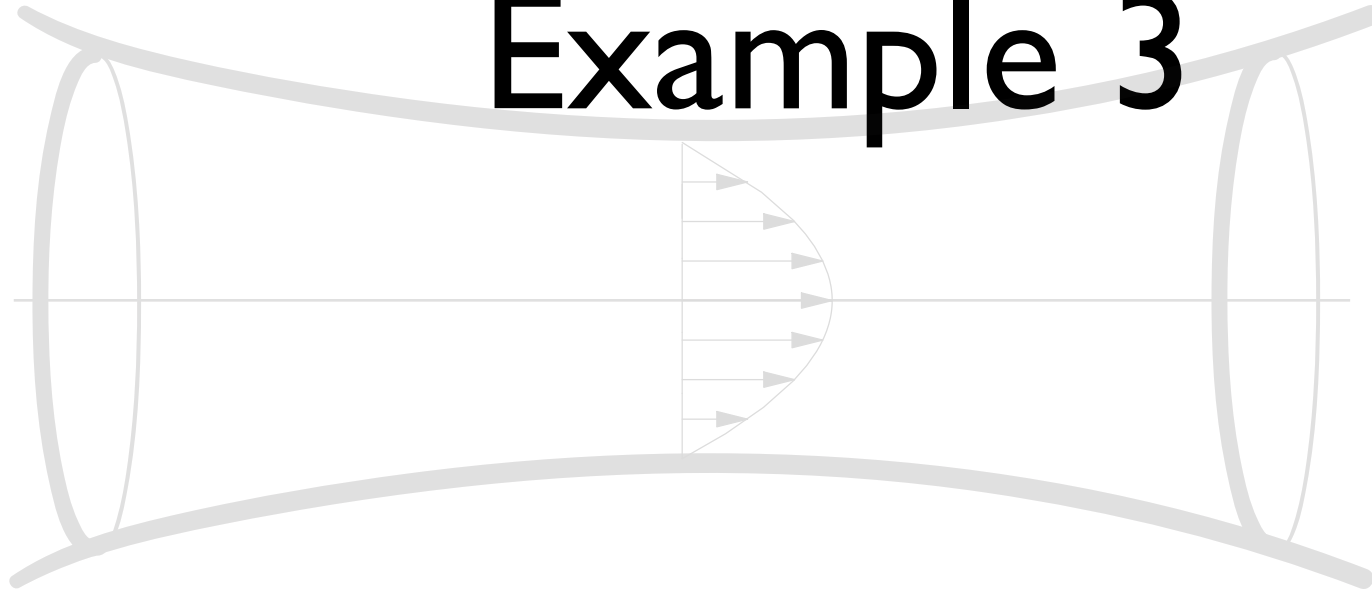

Fig. 4. A comparison between computed skin friction divided by $(0.47 + 2.07)(1 - \alpha)^{-2} Re^{-1/2} \approx (1 - \alpha)^{-2} Re^{1/2}$ for the three models

Example 3



- Flow in a stenosed vessel
- steady, rigid wall
- non symmetrical case

non symmetrical case



- RNSP
- modified integral method to take into account the transverse variation of pressure
- NS

non symmetrical case



- RNSP
- modified integral method to take into account the transverse variation of pressure
- NS

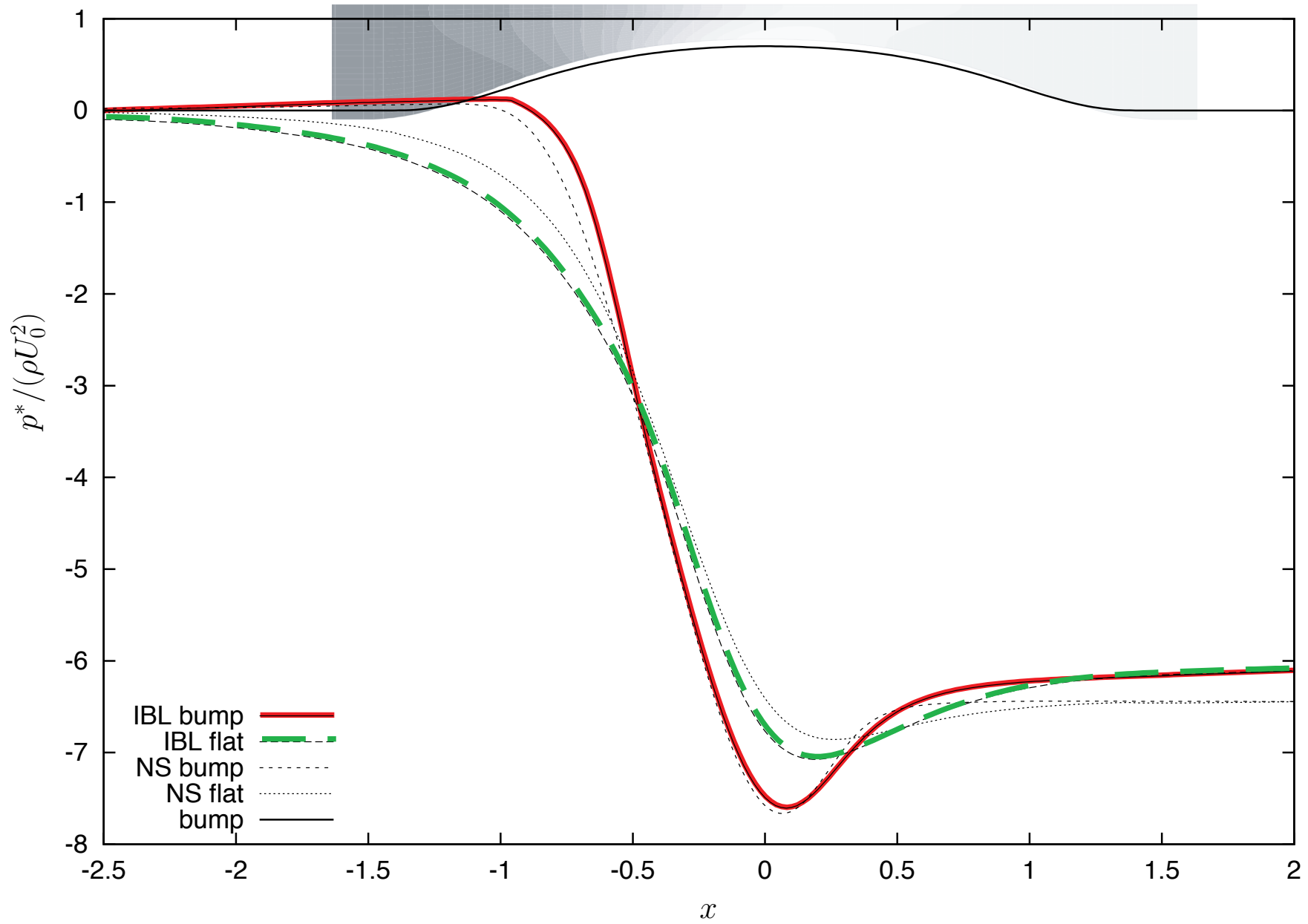

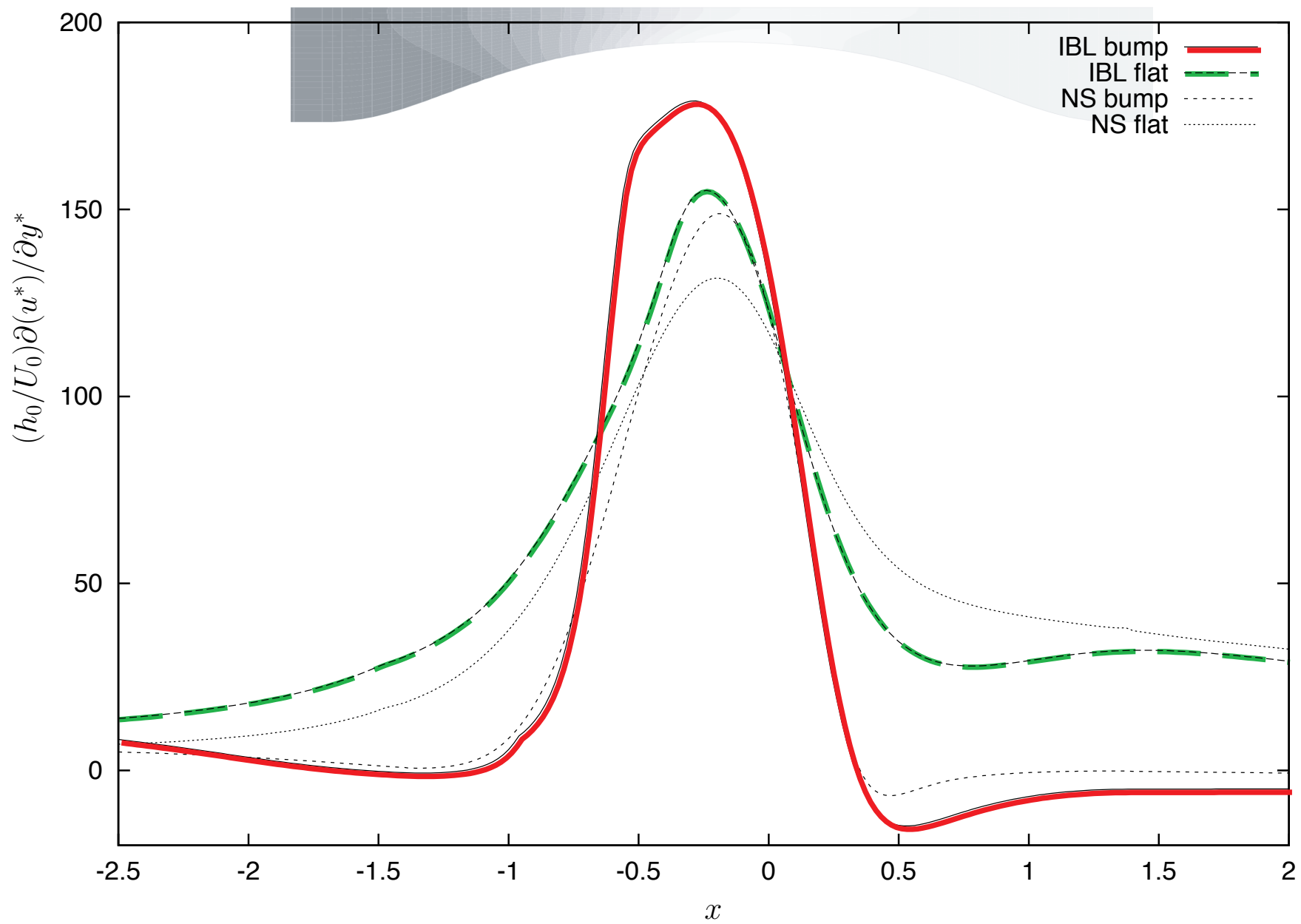

Boundary layer thinner

Acceleration

Boundary layer thicker

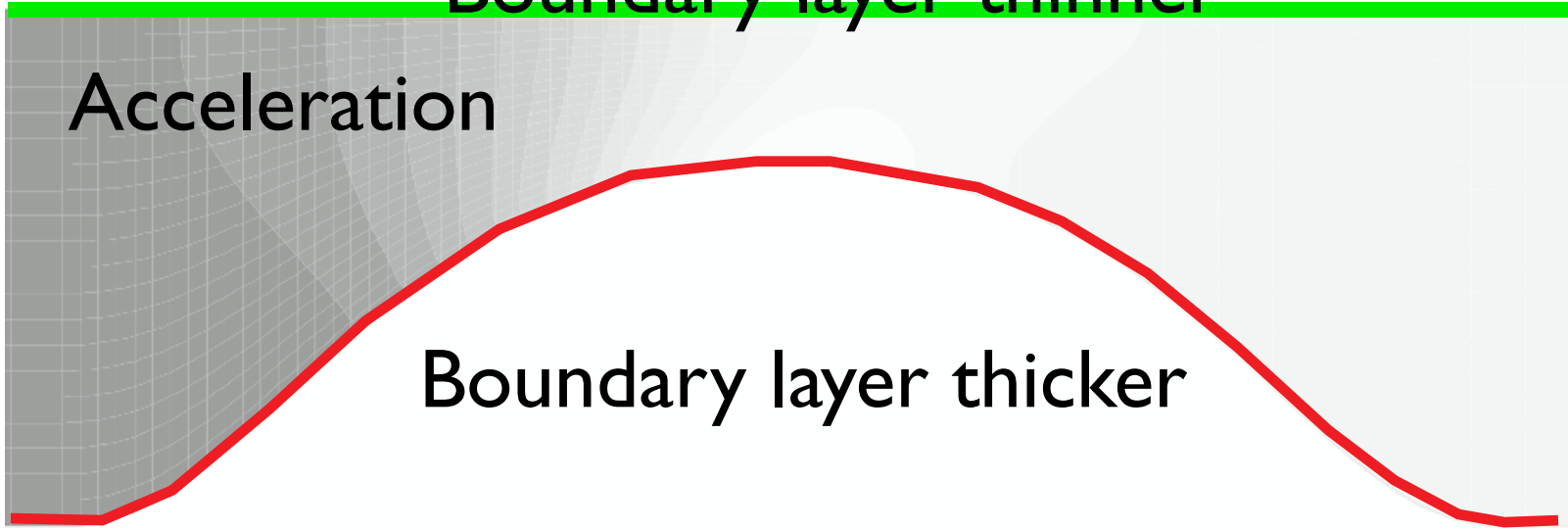

Boundary layer thinner

Acceleration

expansion

Boundary layer thicker

pressure

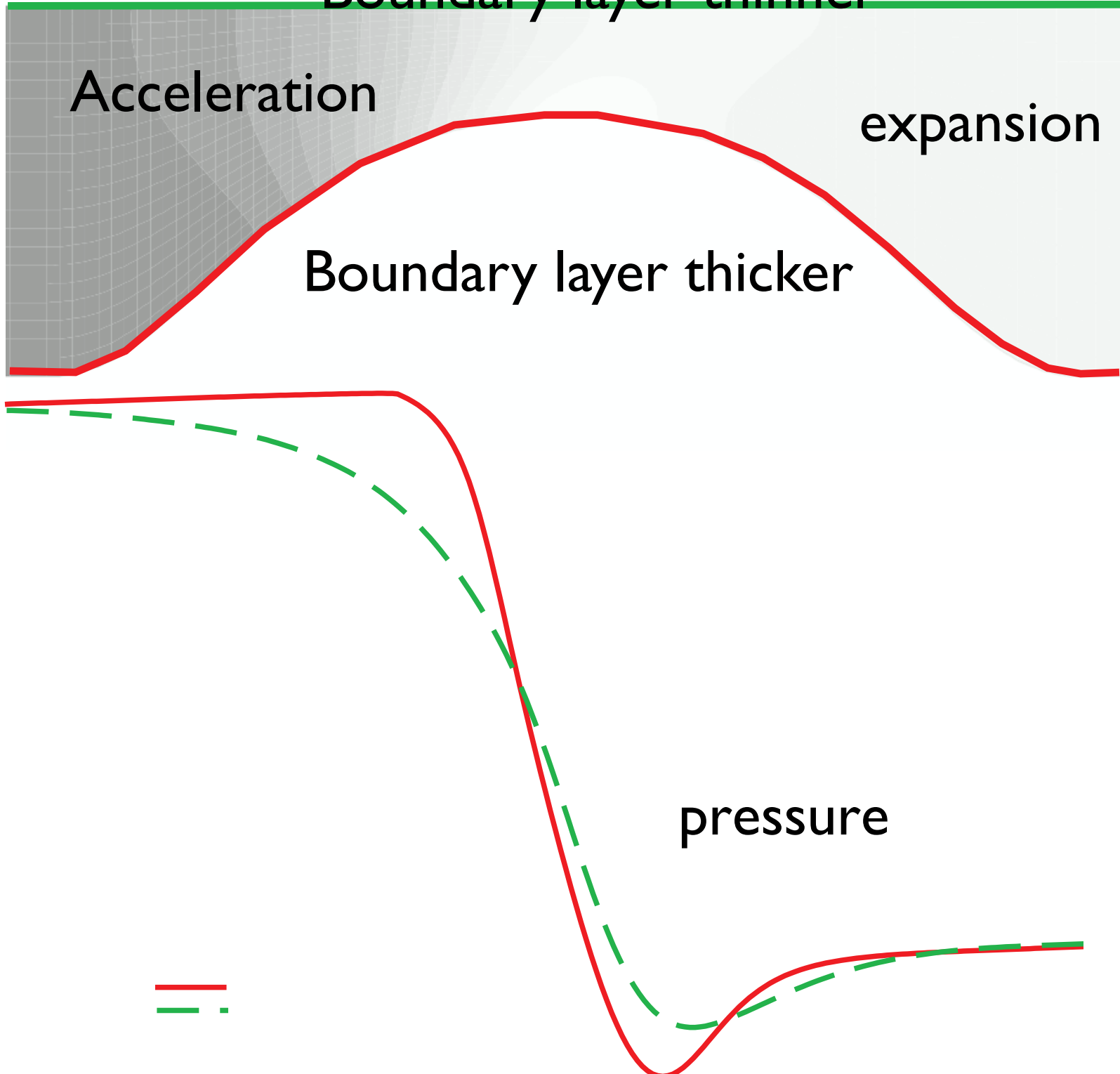

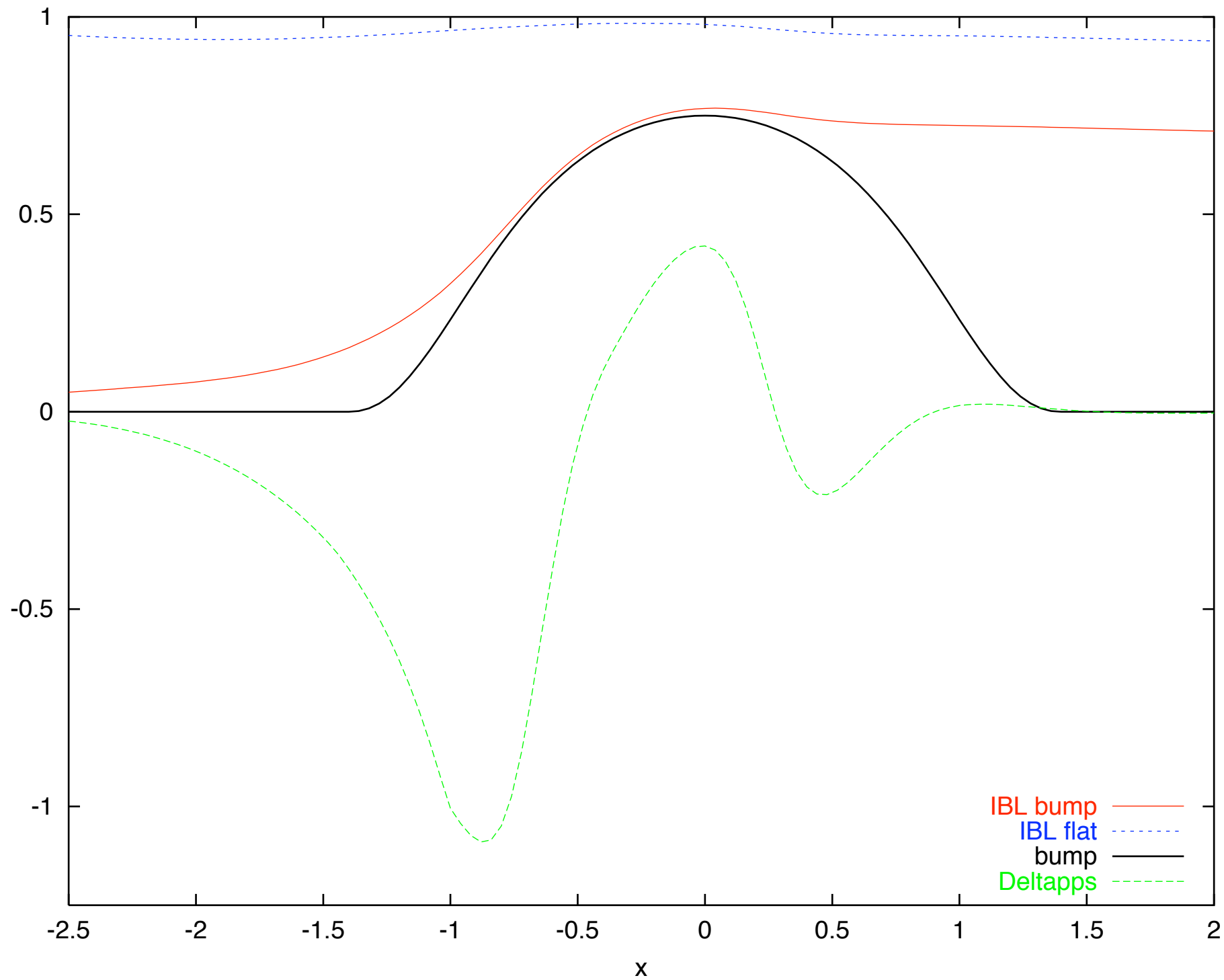

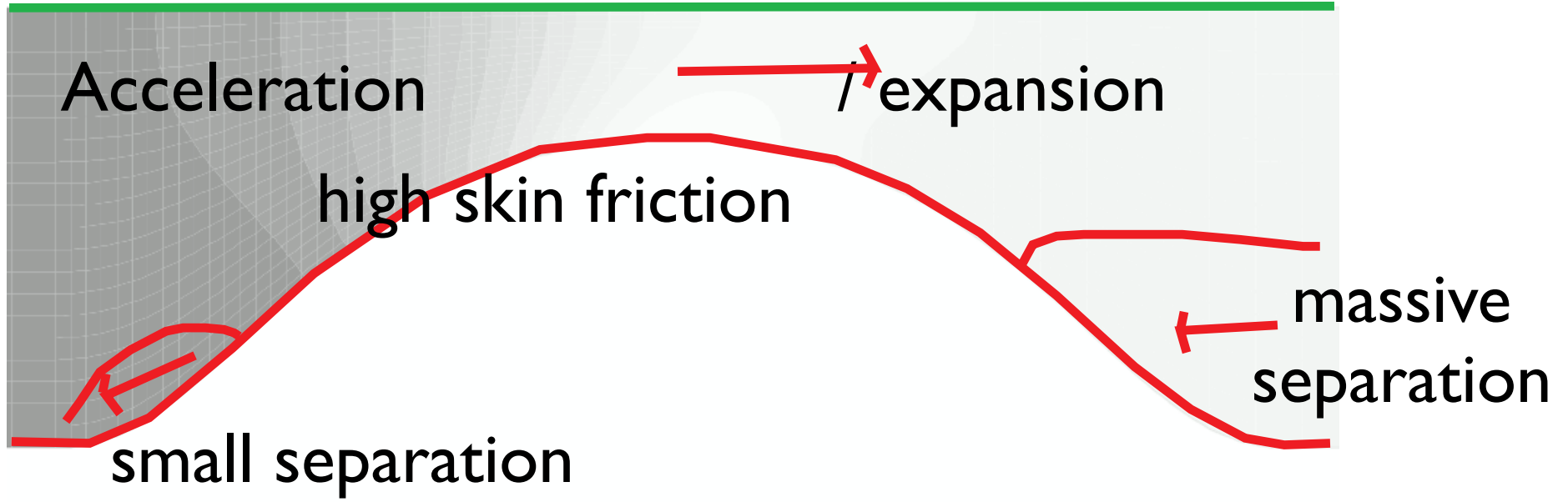

Example 4



- Flow in a stenosed vessel/ aneurism
- unsteady, rigid wall

Example 2

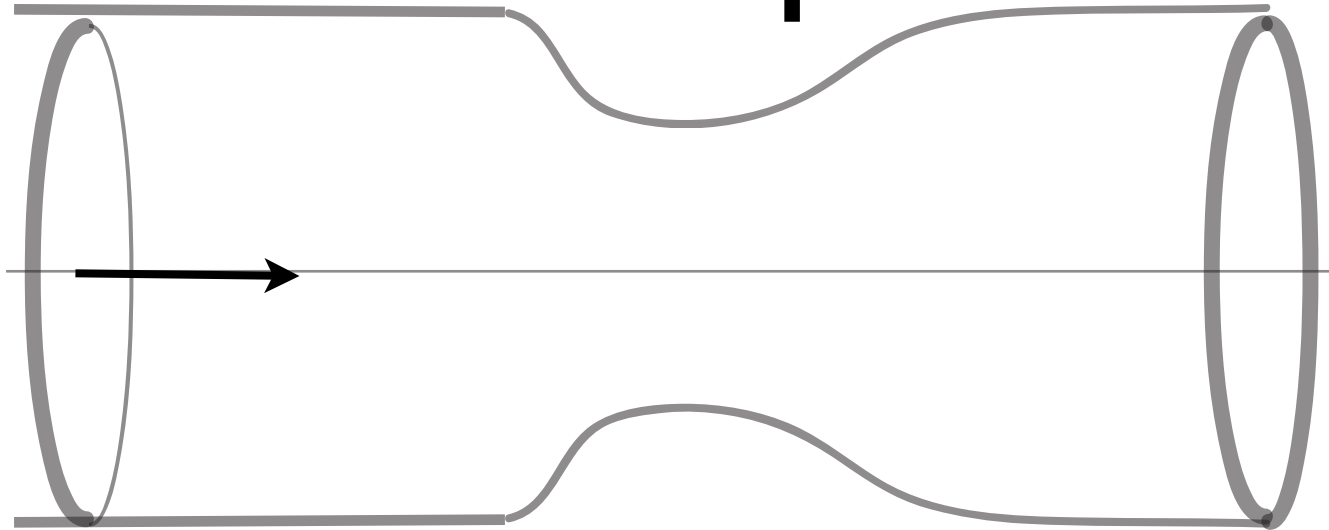

- Flow in a stenosed vessel/
- unsteady, rigid wall

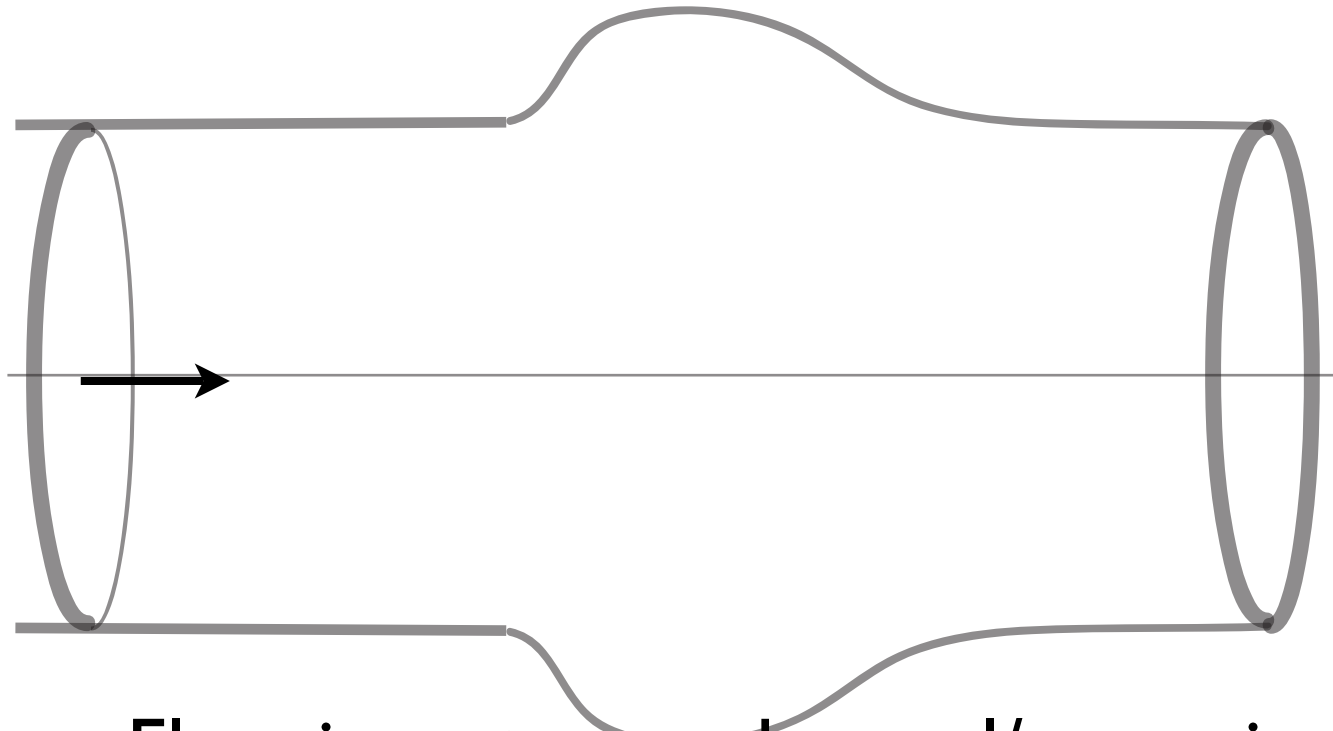

- Flow in a stenozed vessel/ aneurism
- unsteady, rigid wall

- Stenosis

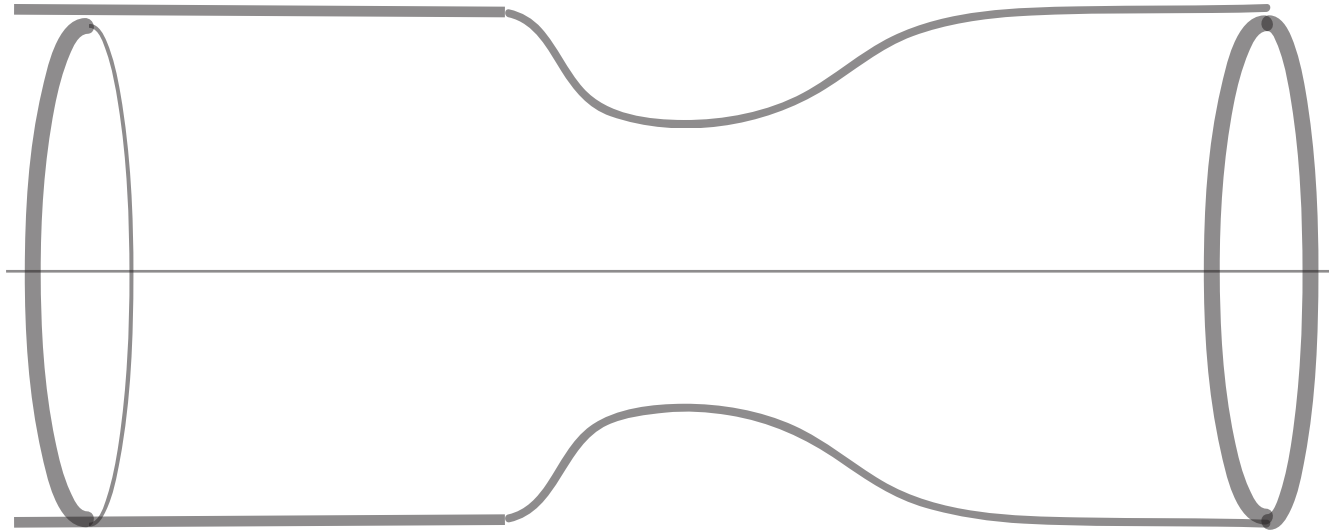

- Stenosis

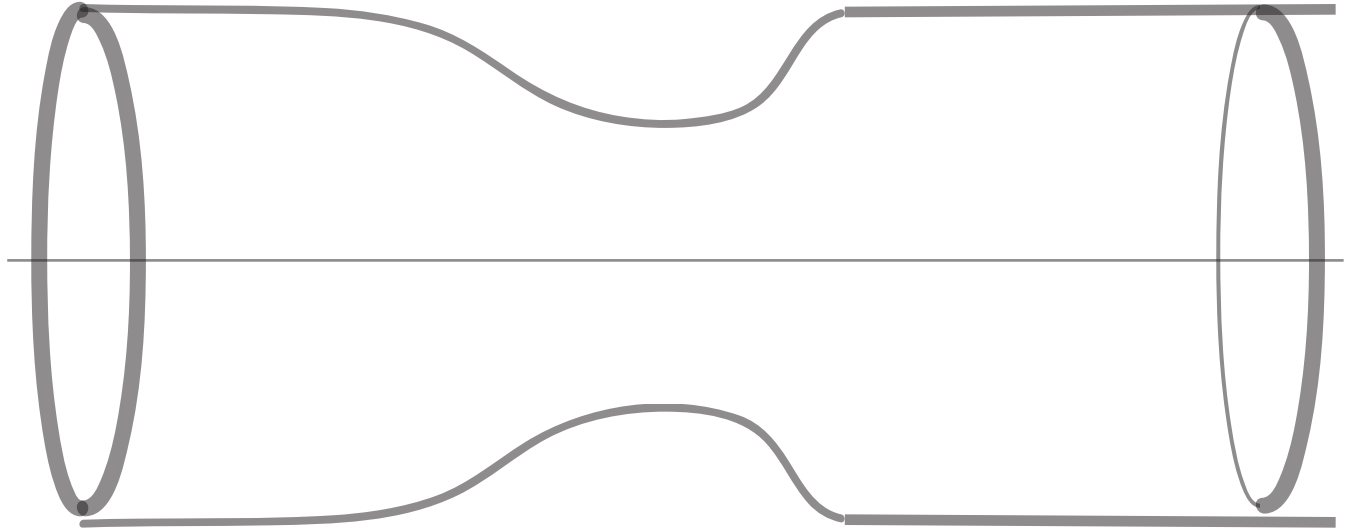

- Stenosis

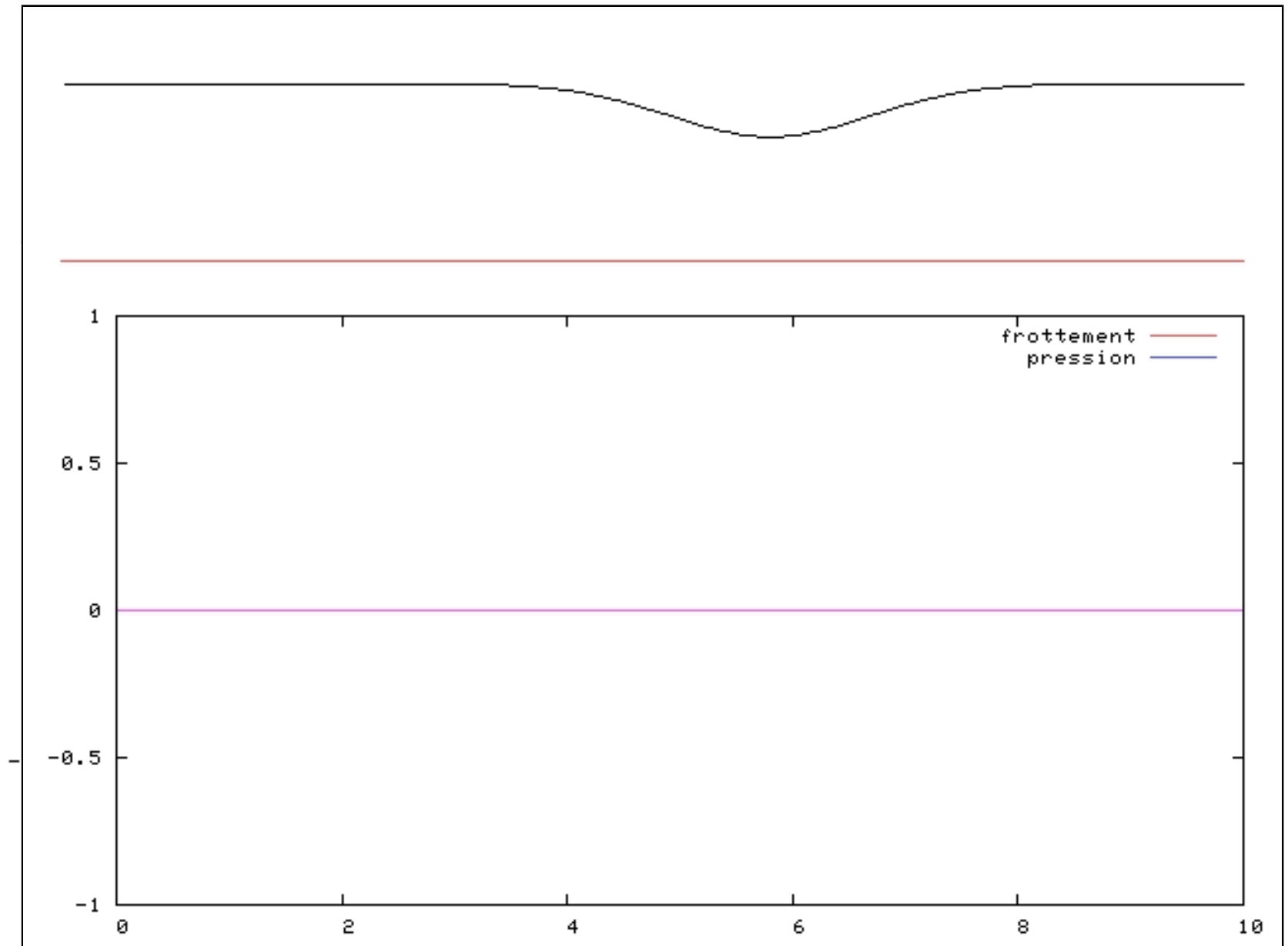

- Aneurism

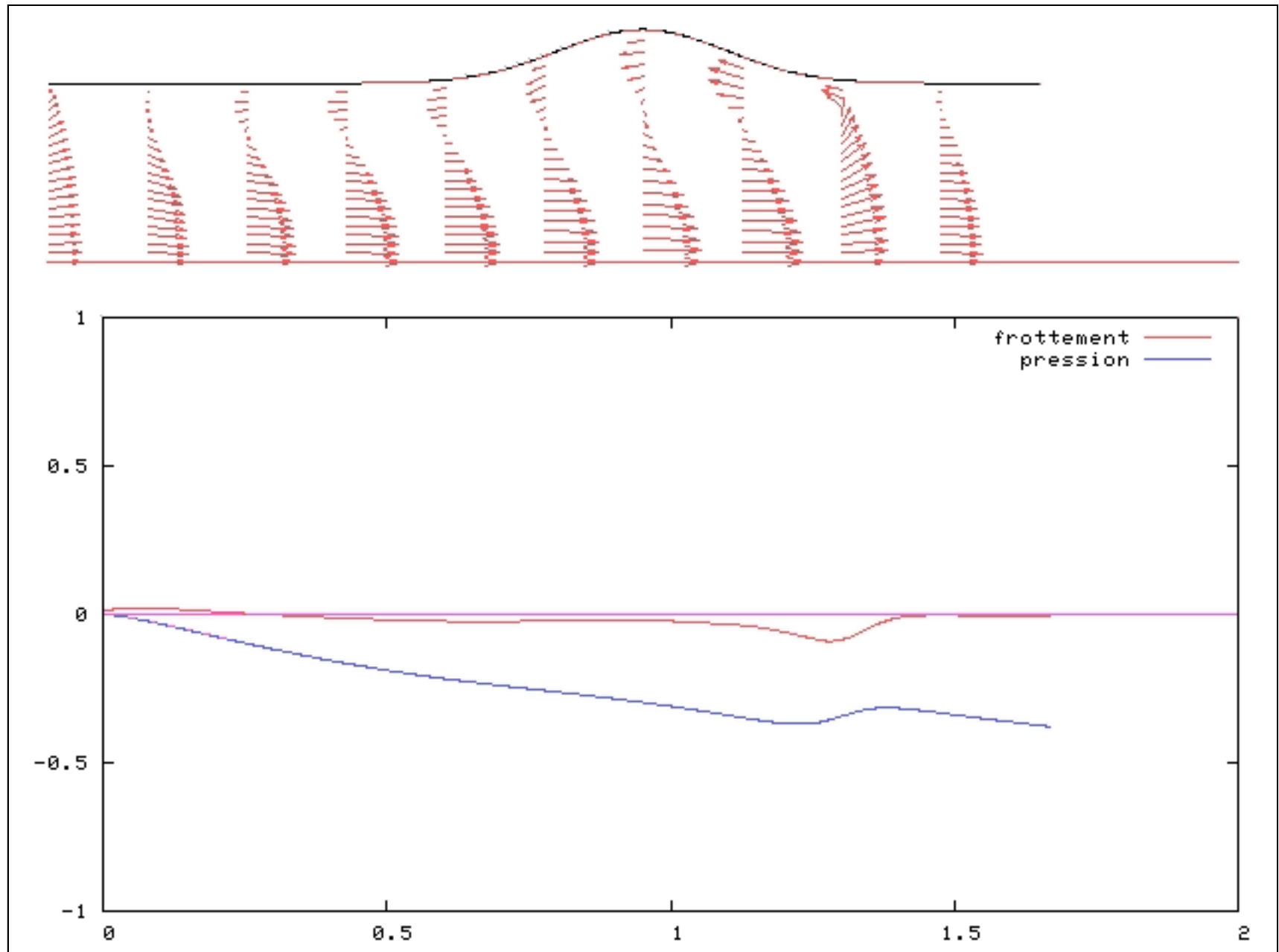

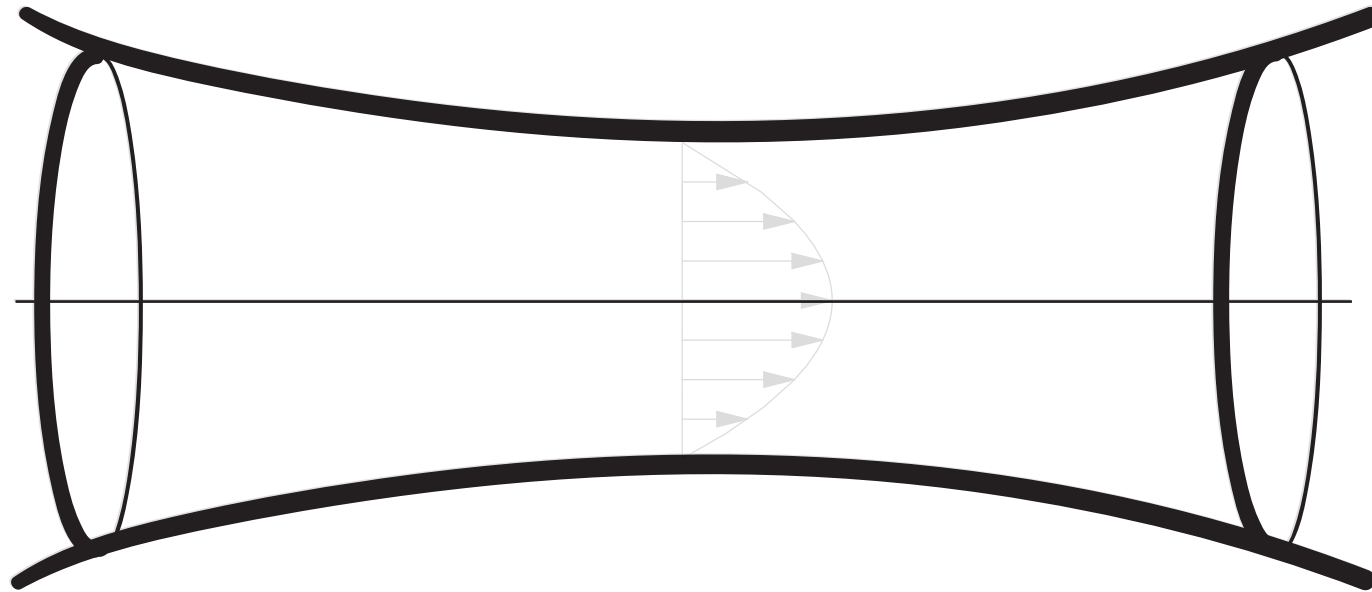

Up to now, the wall was rigid

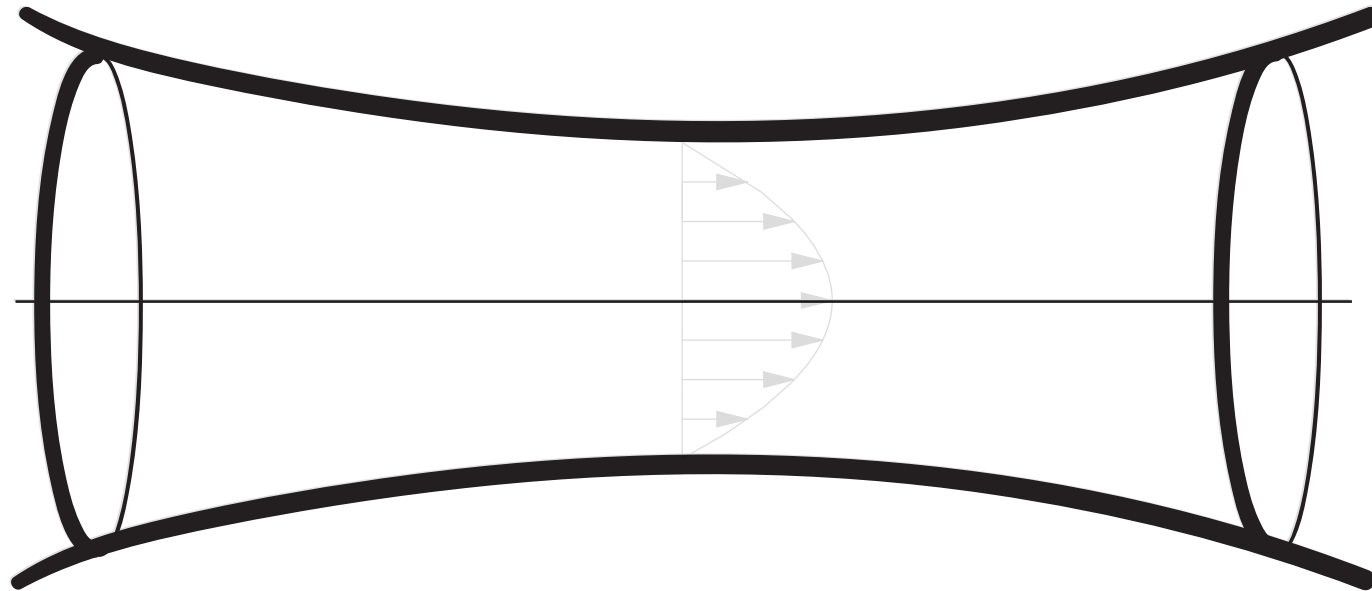

we use a simple elastic model

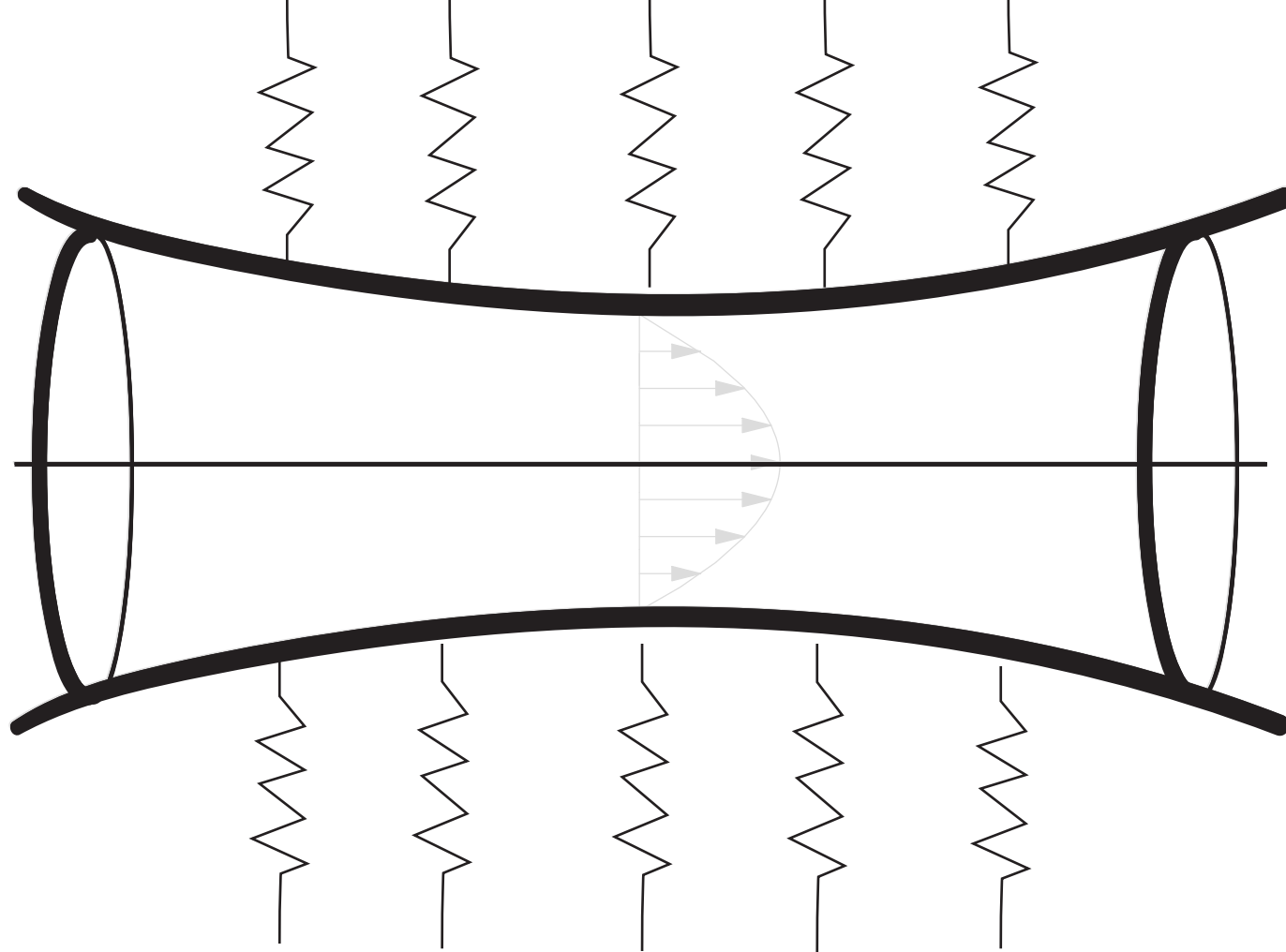

we use a simple elastic model

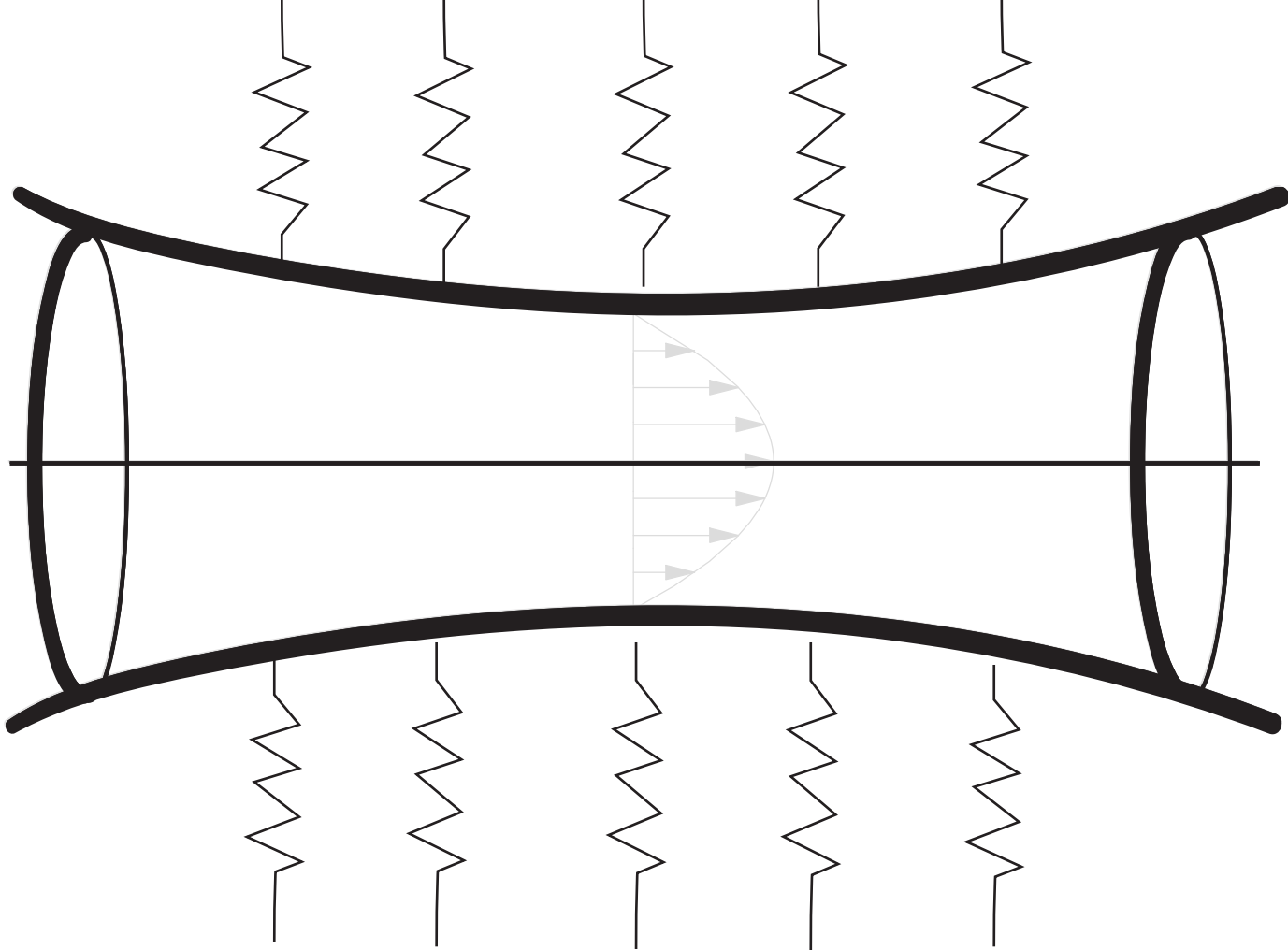

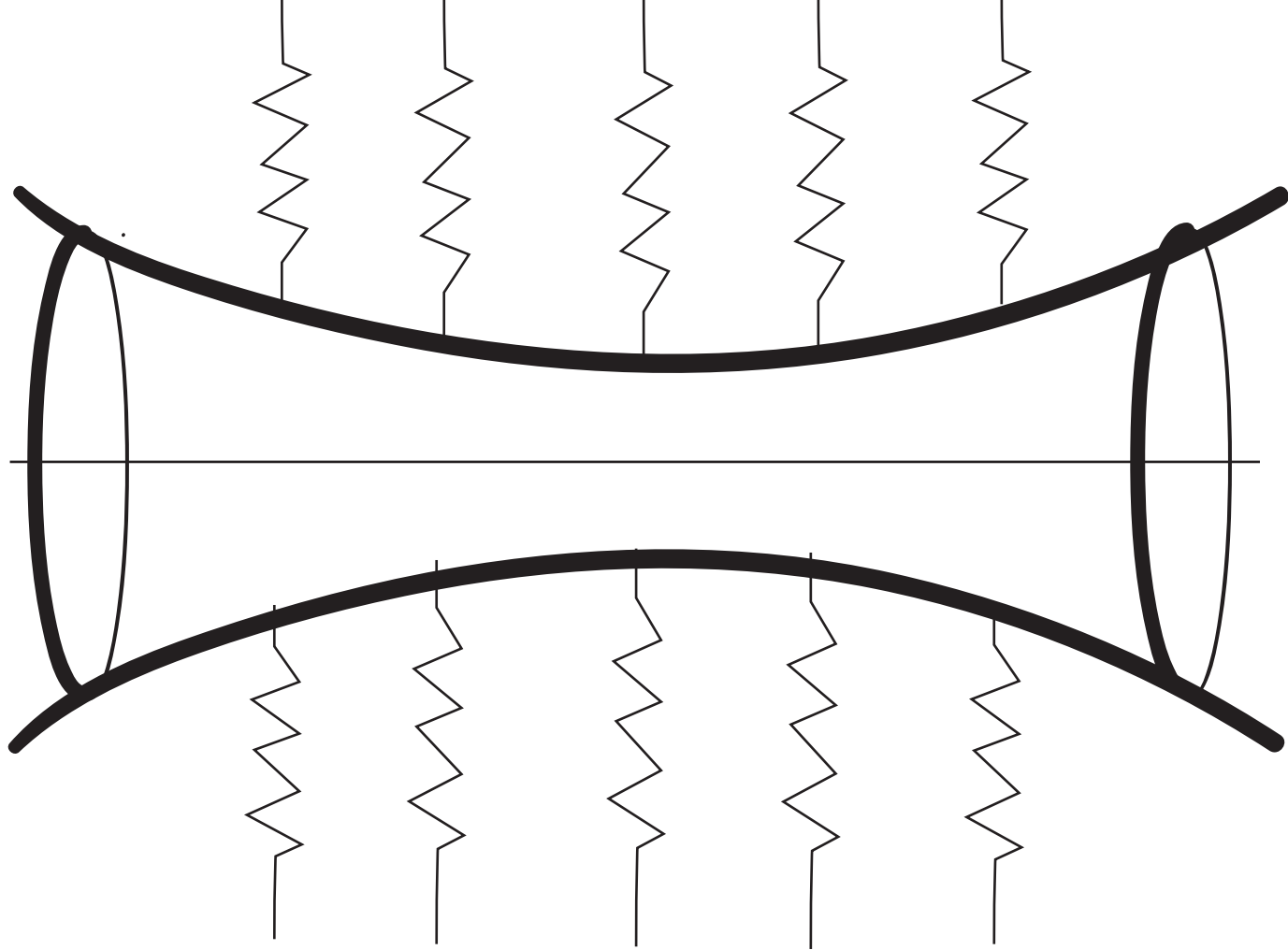

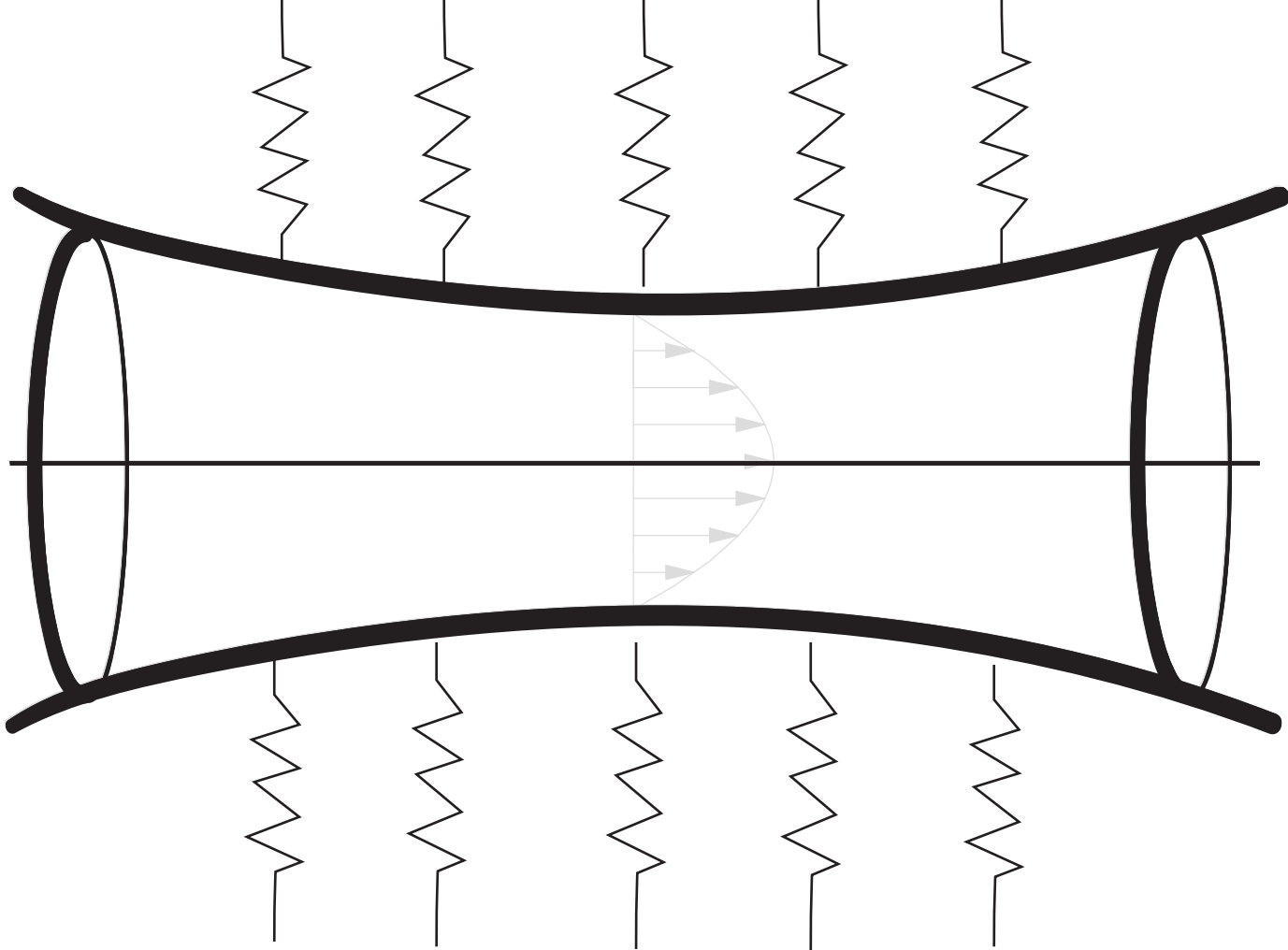

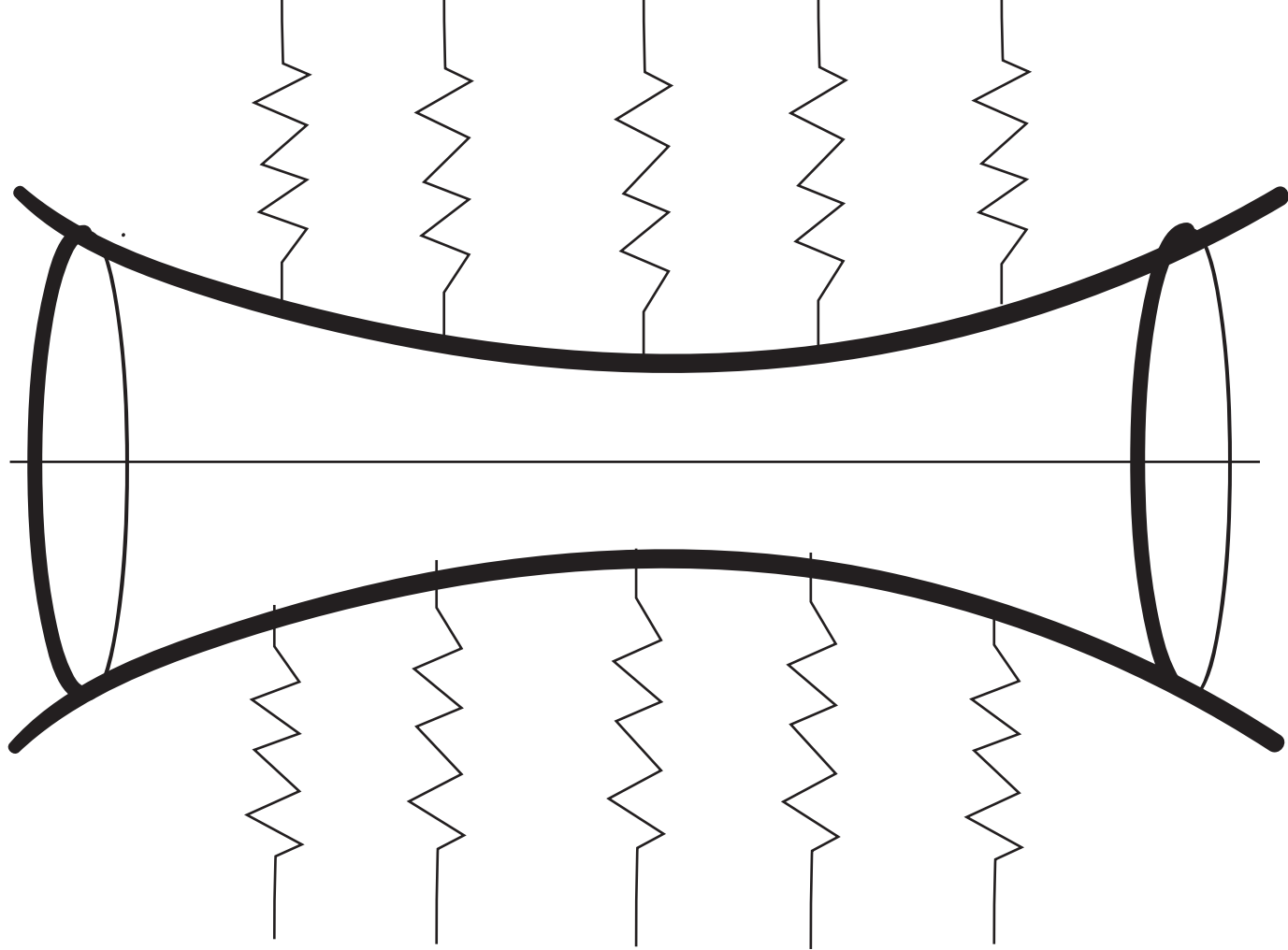

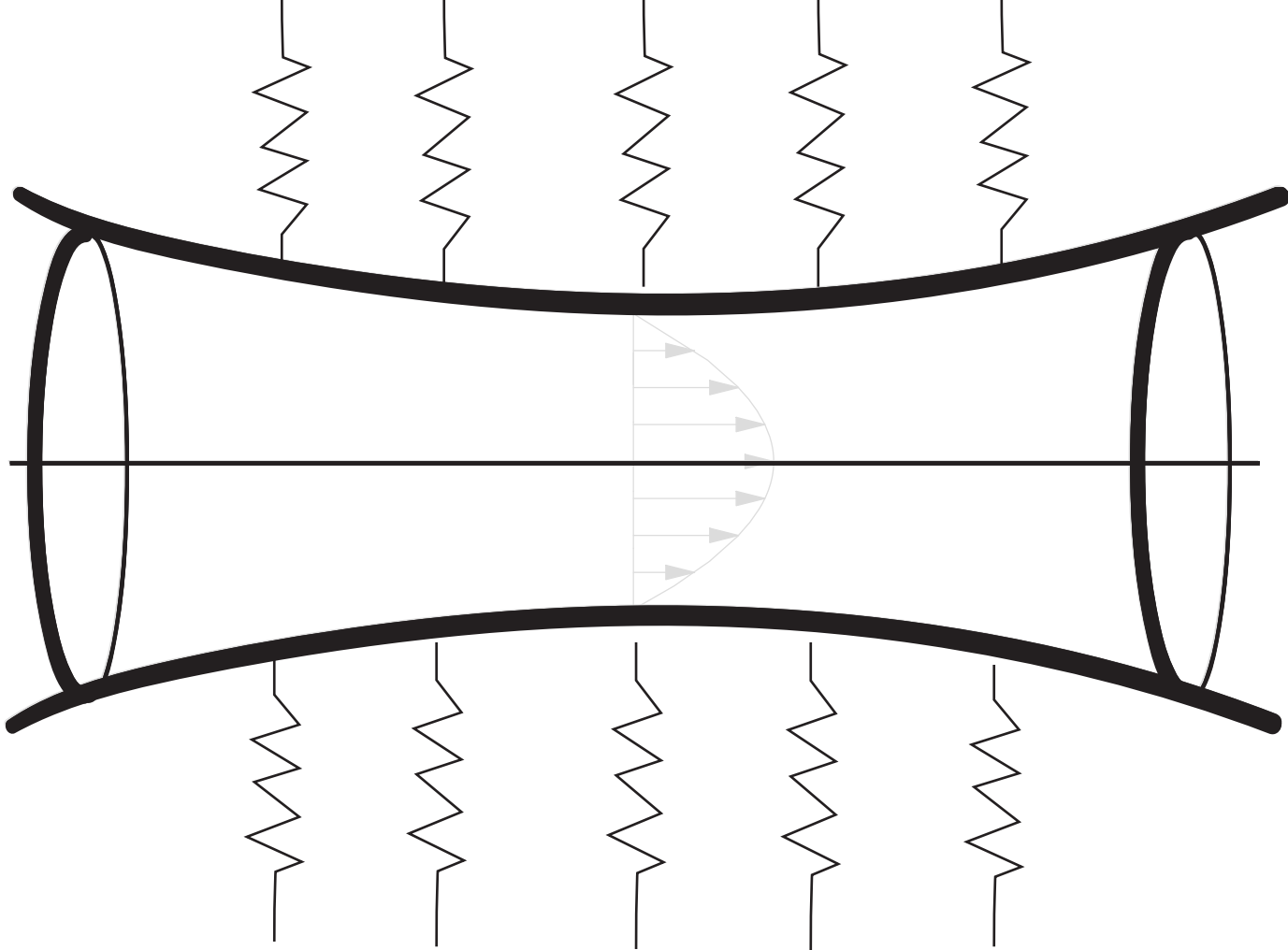

Example 5

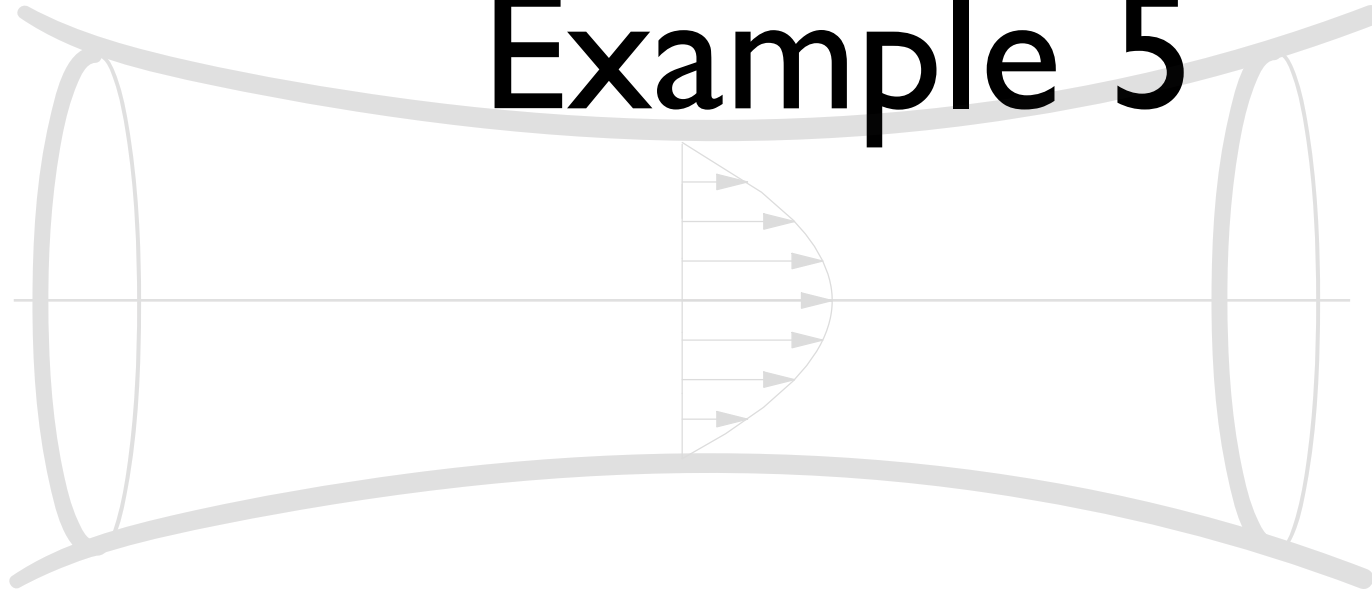

- Flow in a collapsible tube
- unsteady, elastic wall, no inertia

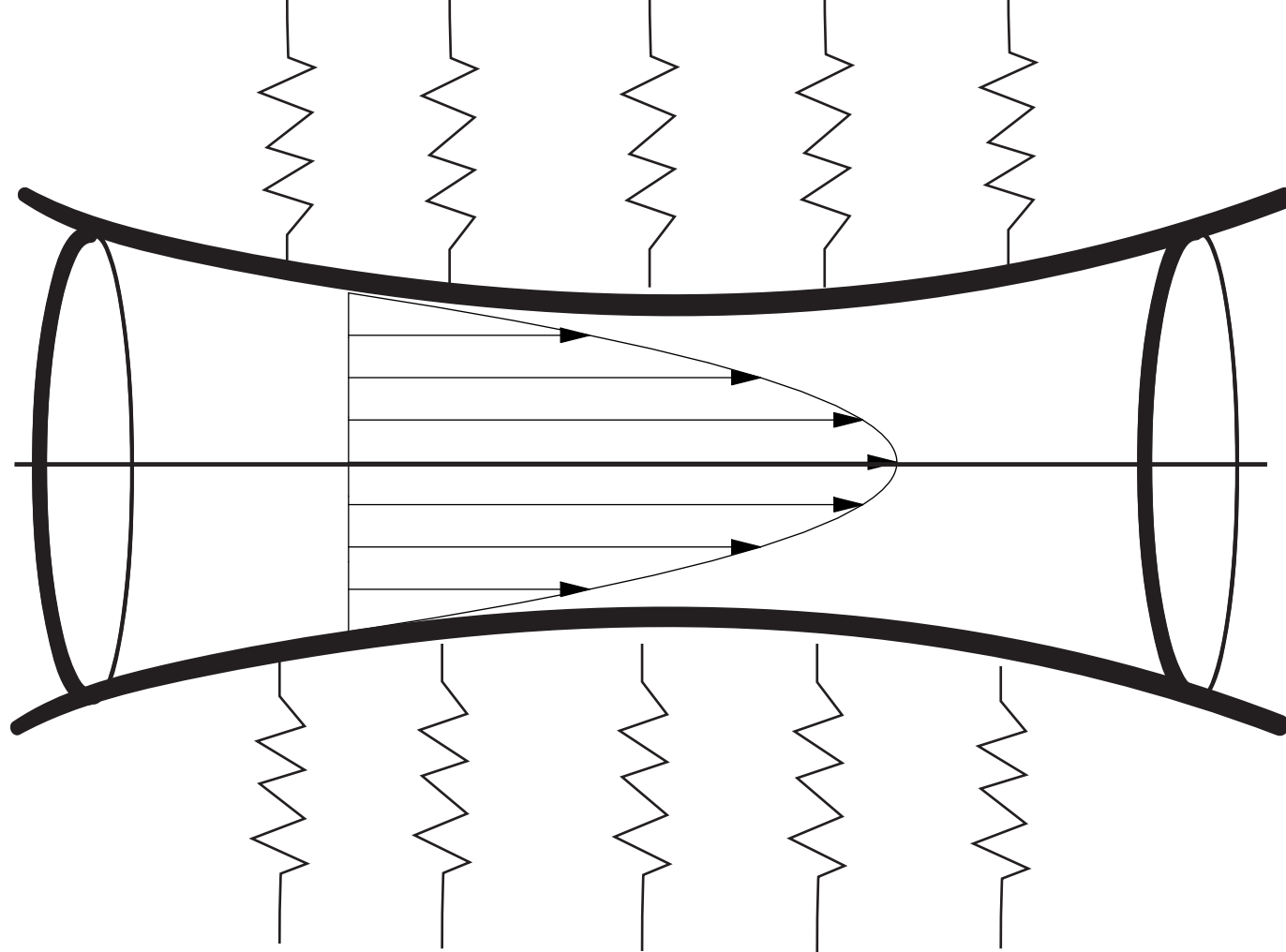

Collapsible tube

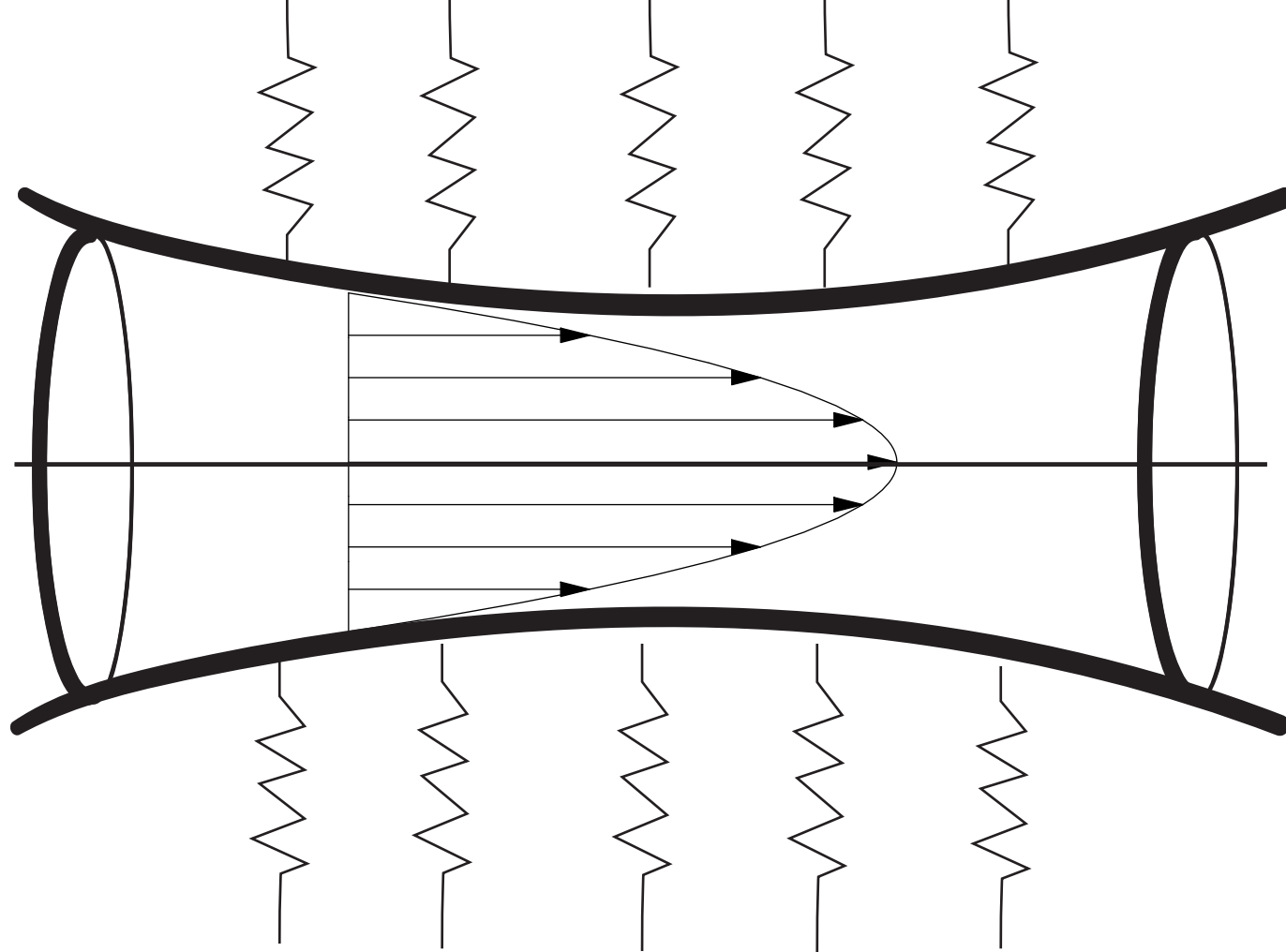

R^n gives p^{n+1}

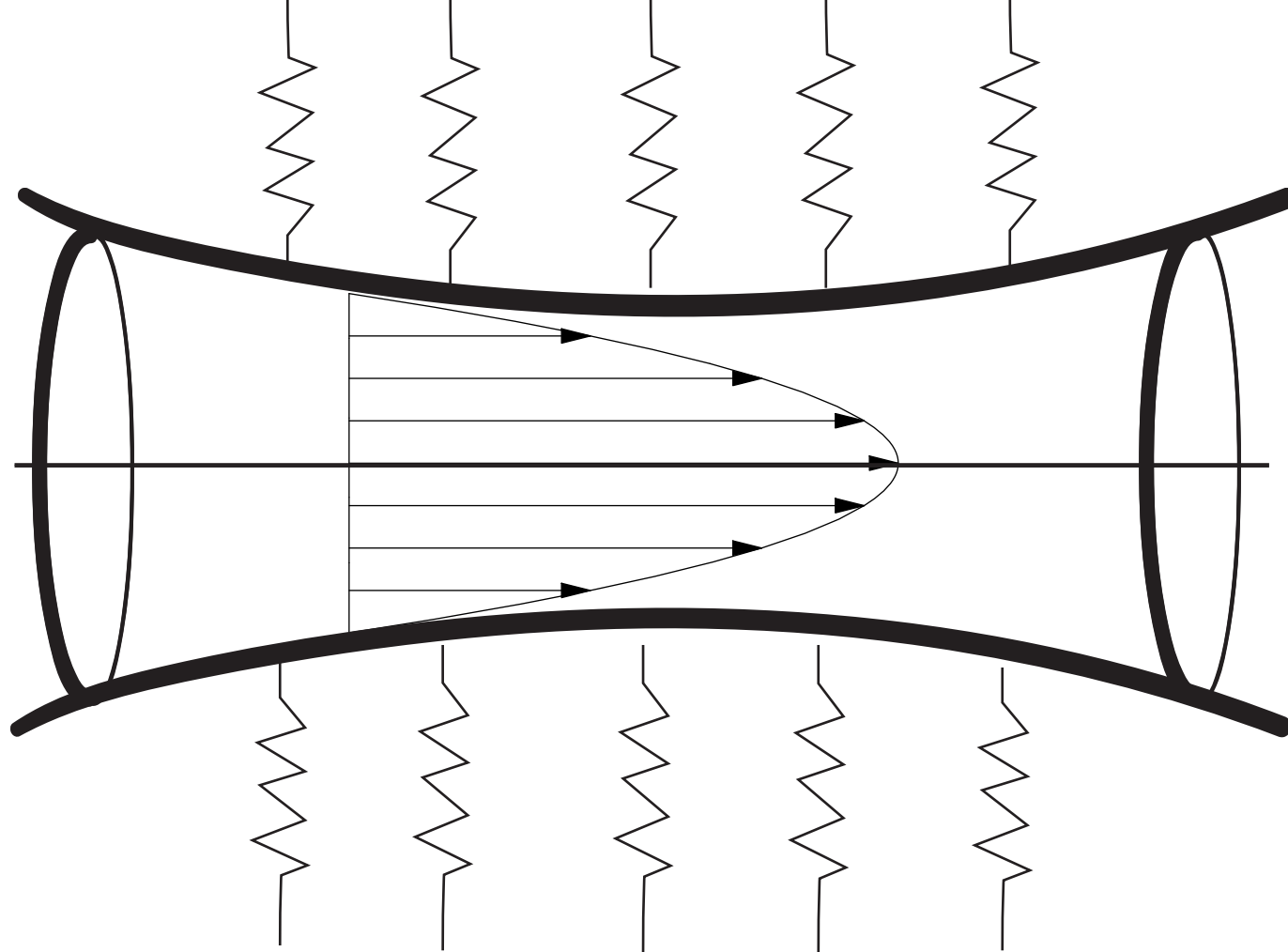

$$R^n \text{ gives } p^{n+1} \longrightarrow p^{n+1} = k(R^{n+1} - 1)$$

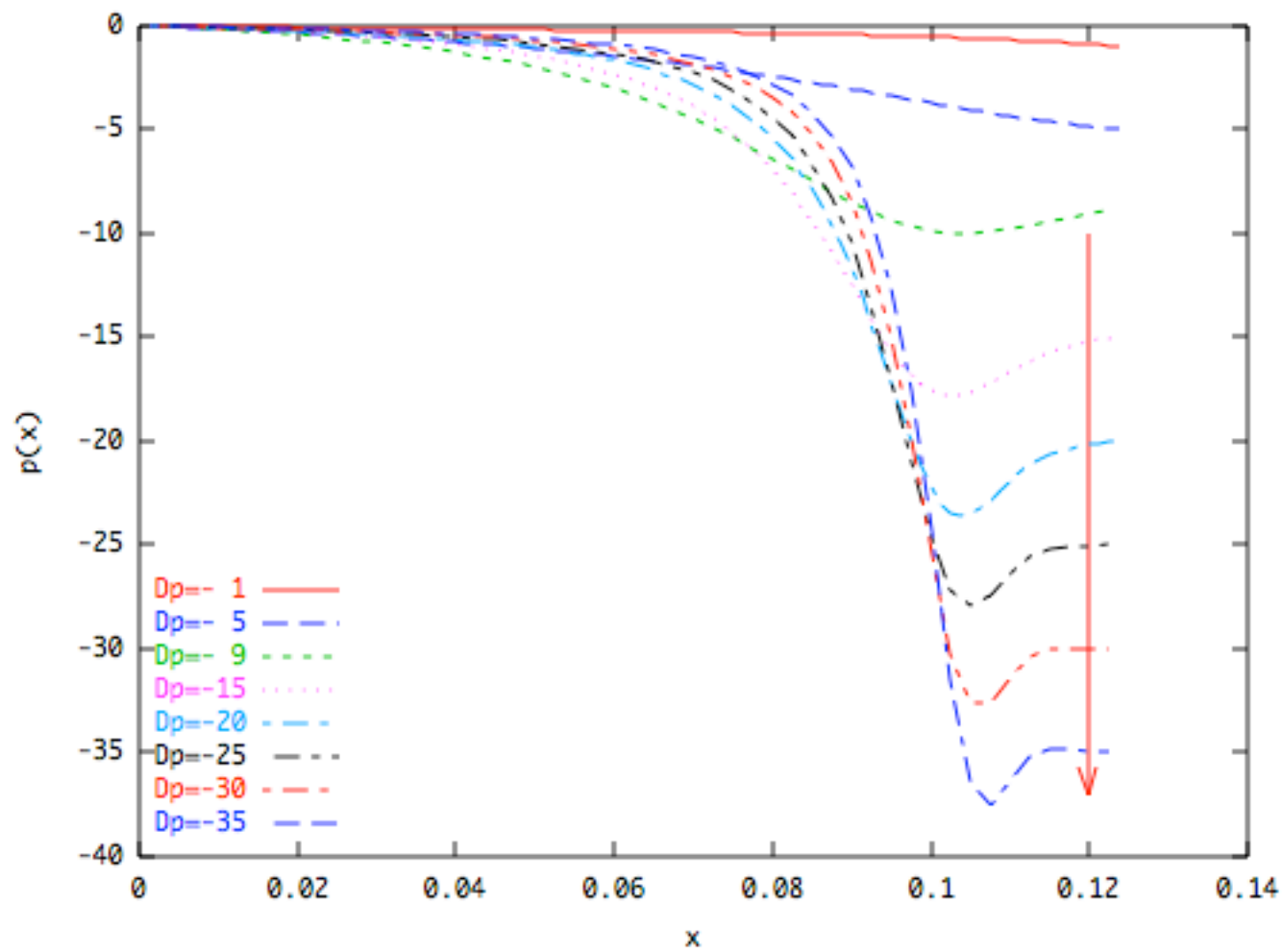
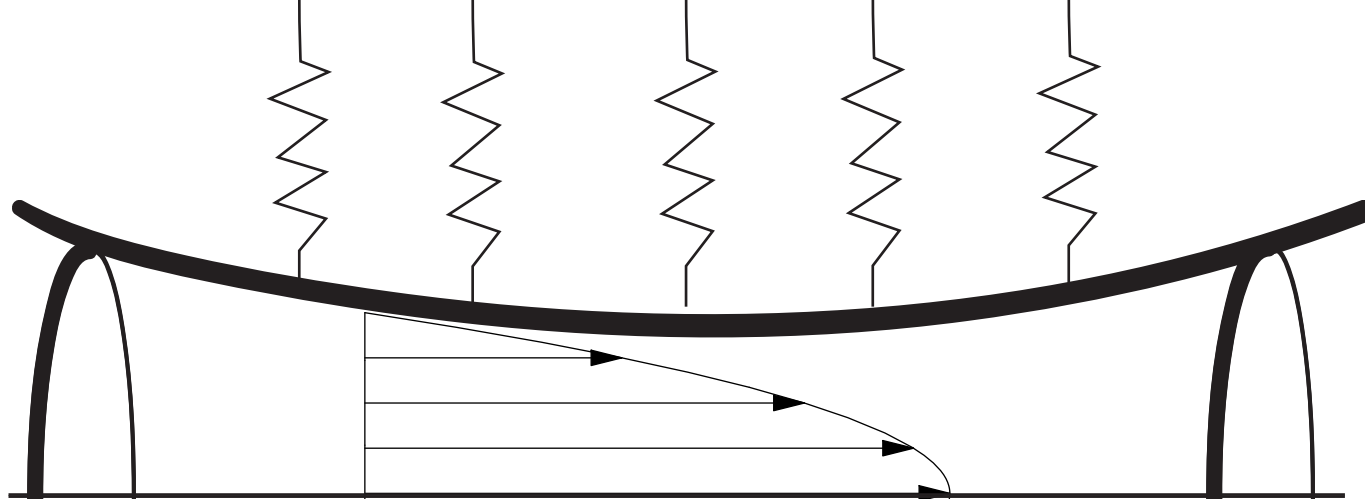

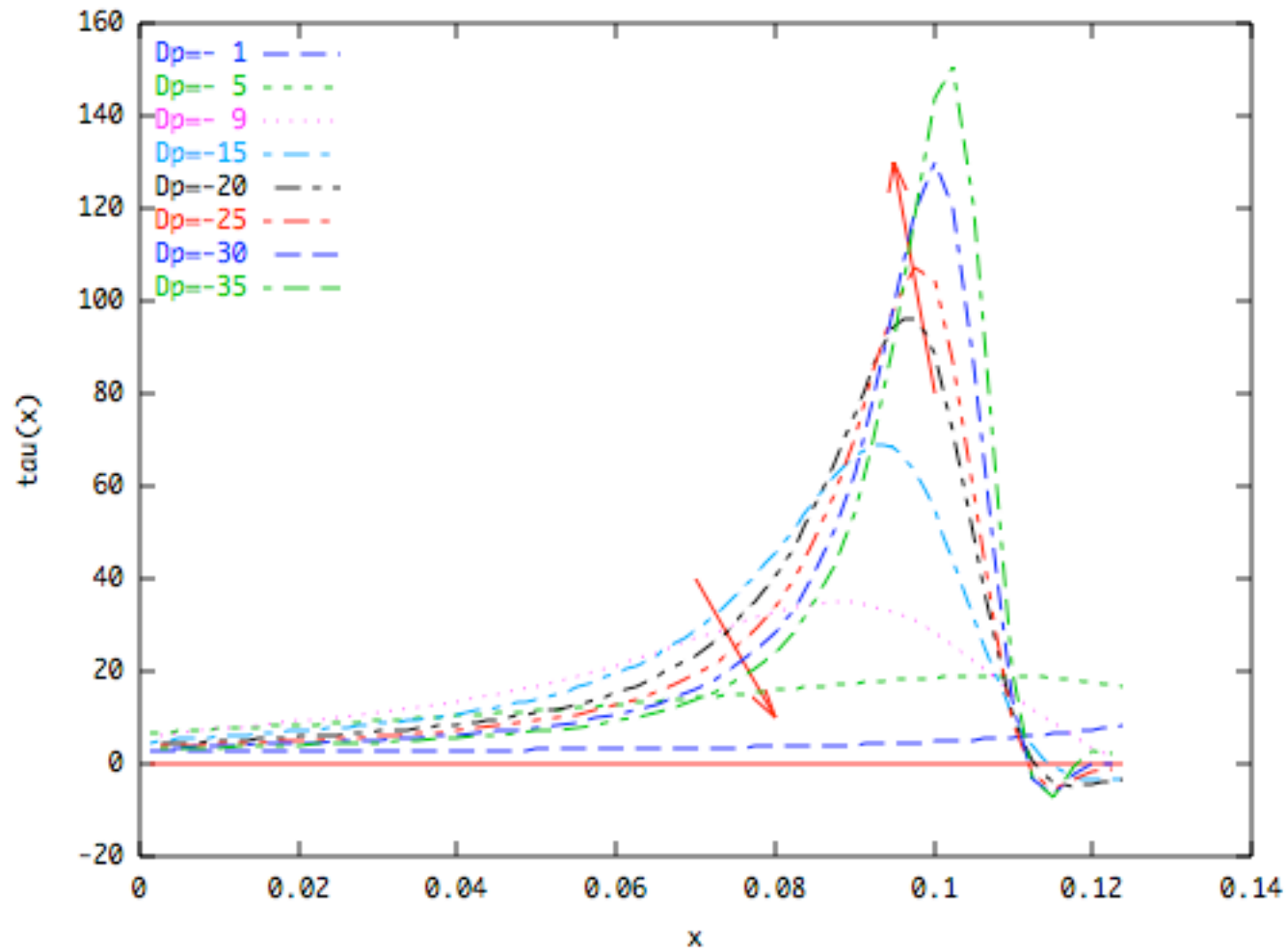
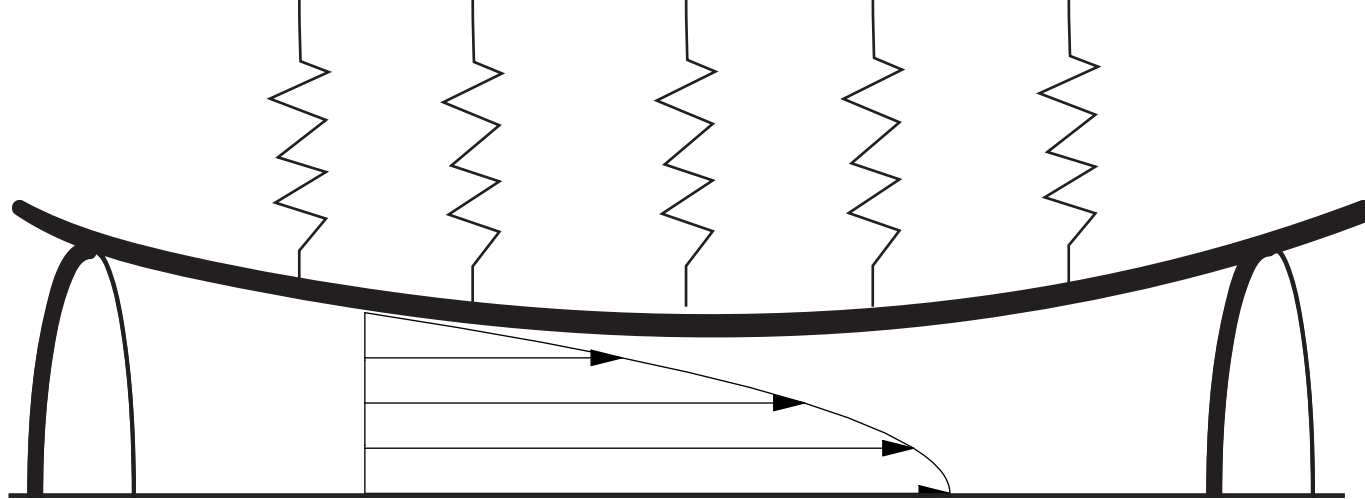

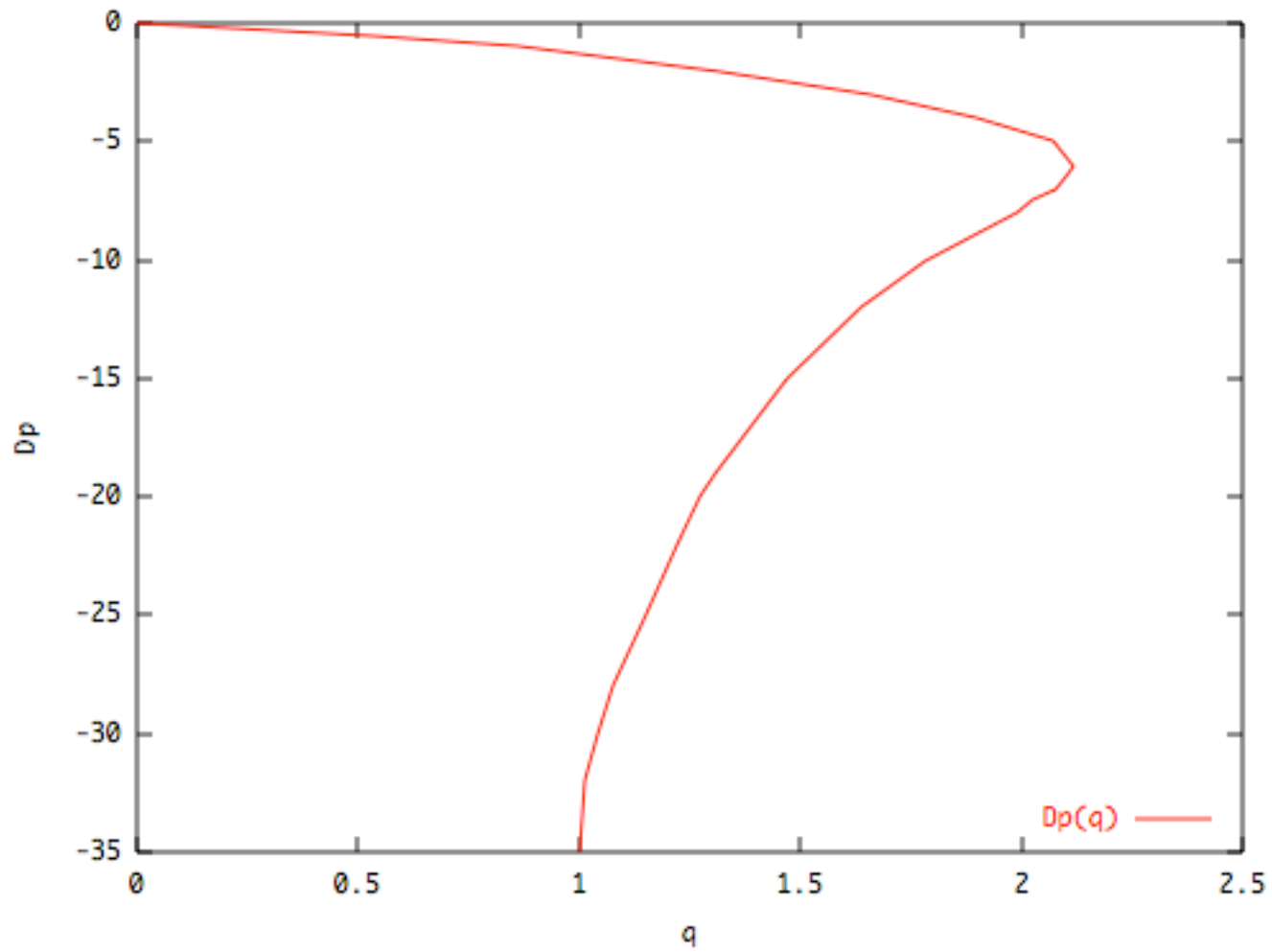
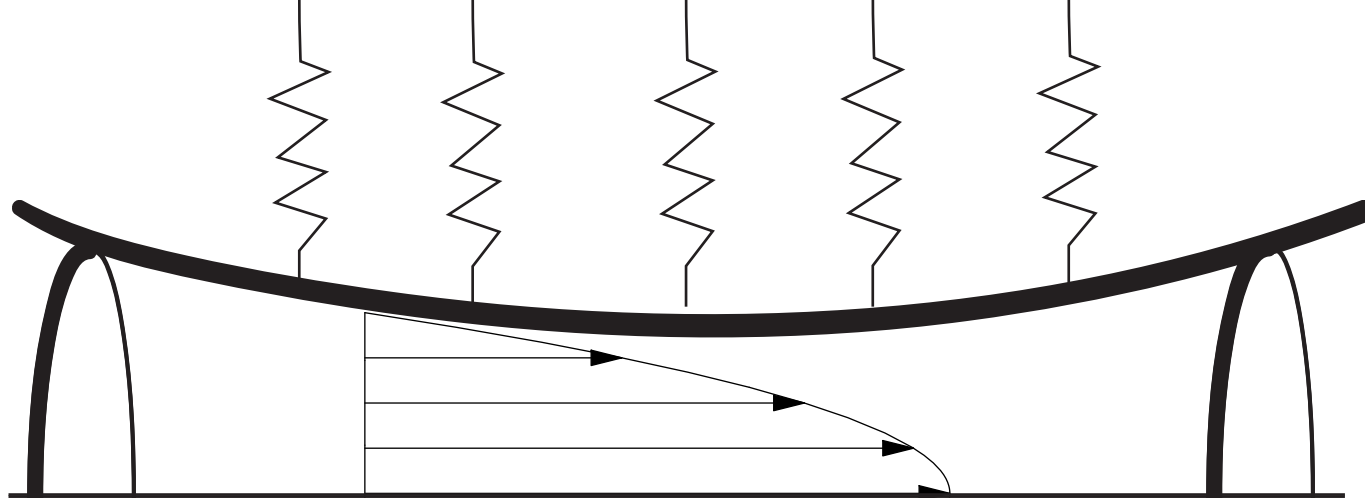

Example 6

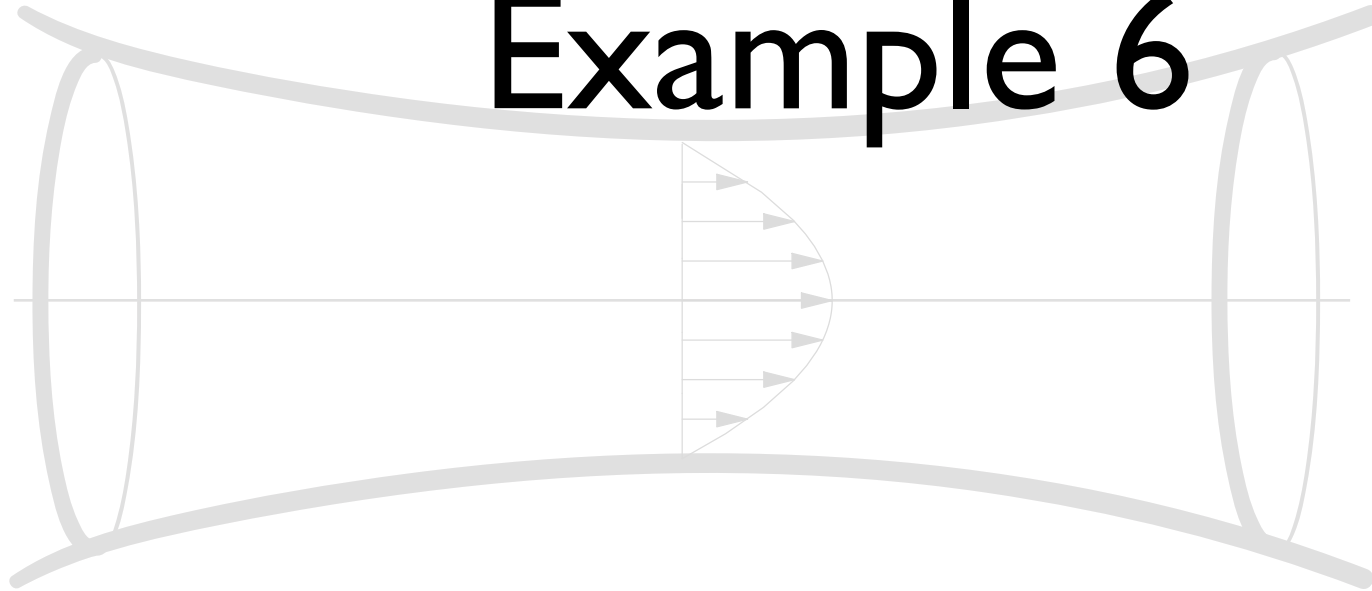

- flow with elastic wall with mass (glottis)

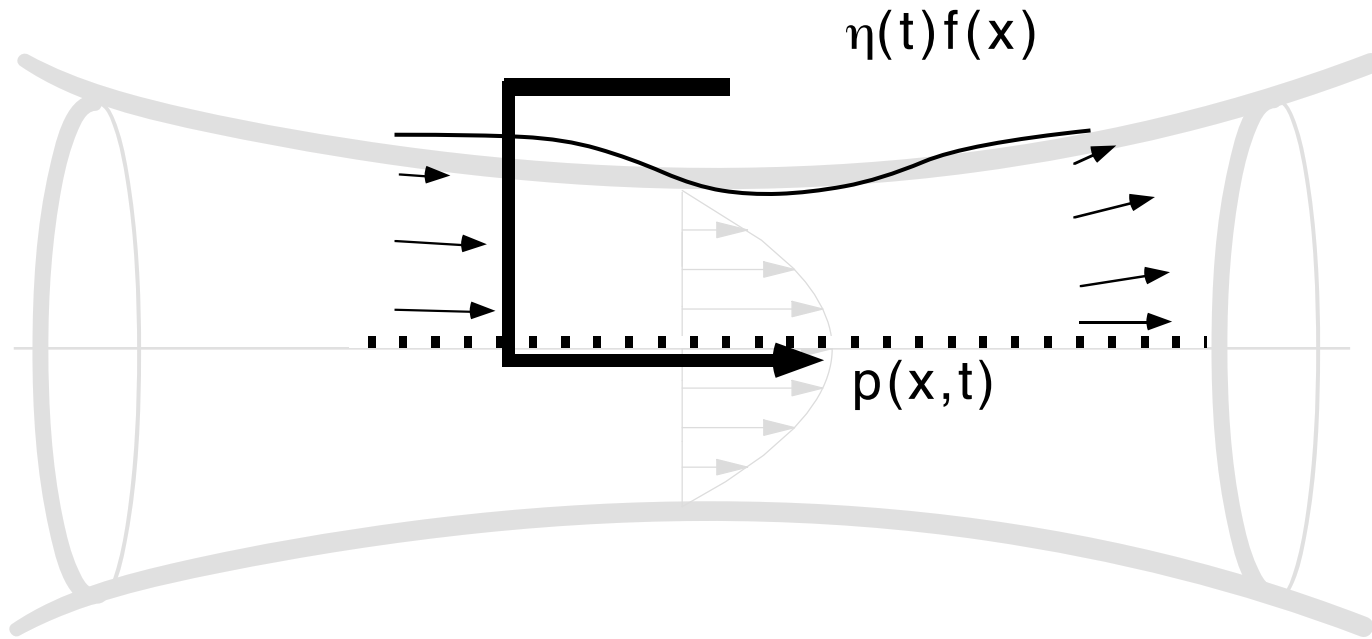

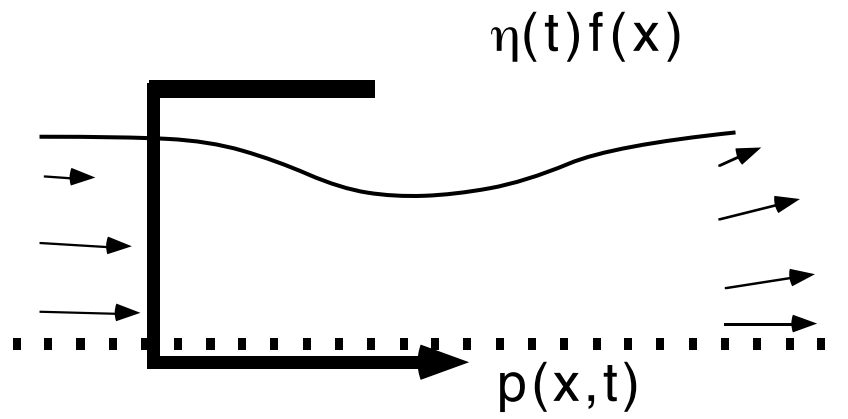

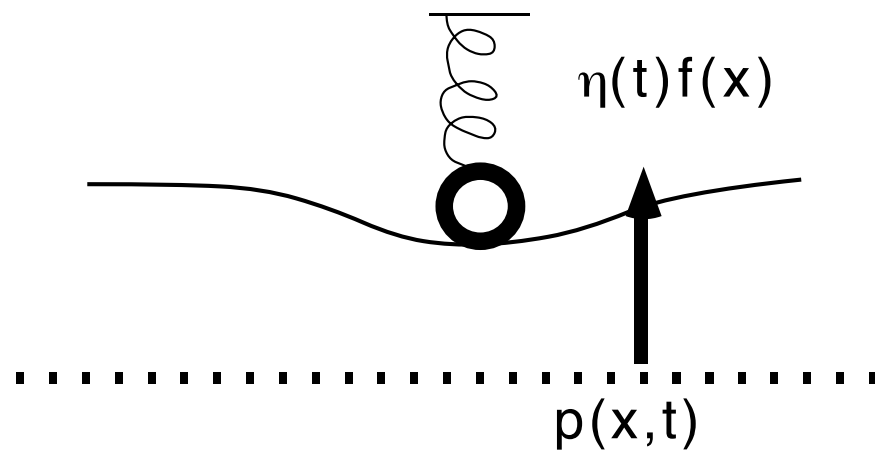

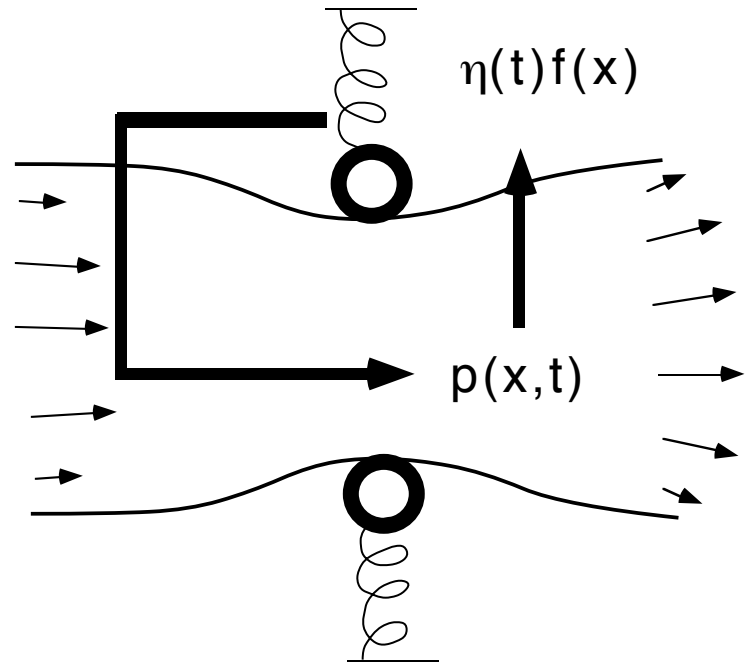

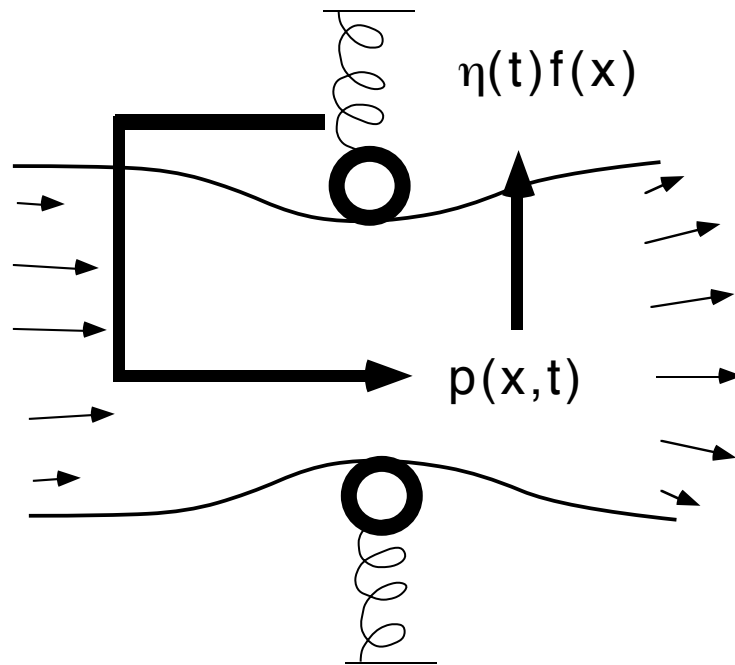

$$\mu \frac{\partial^2 \eta}{\partial t^2} + k\eta = -p$$

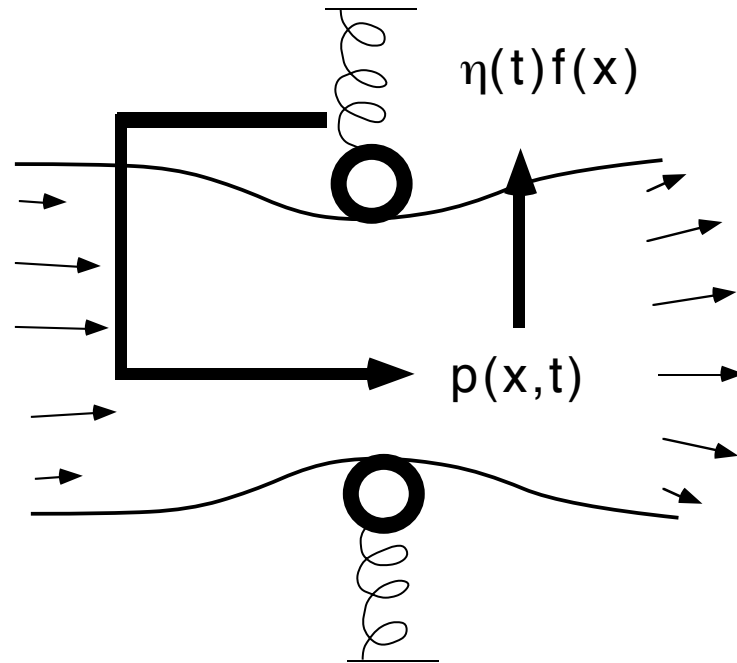

Newmark method for the spring:
prediction/ correction

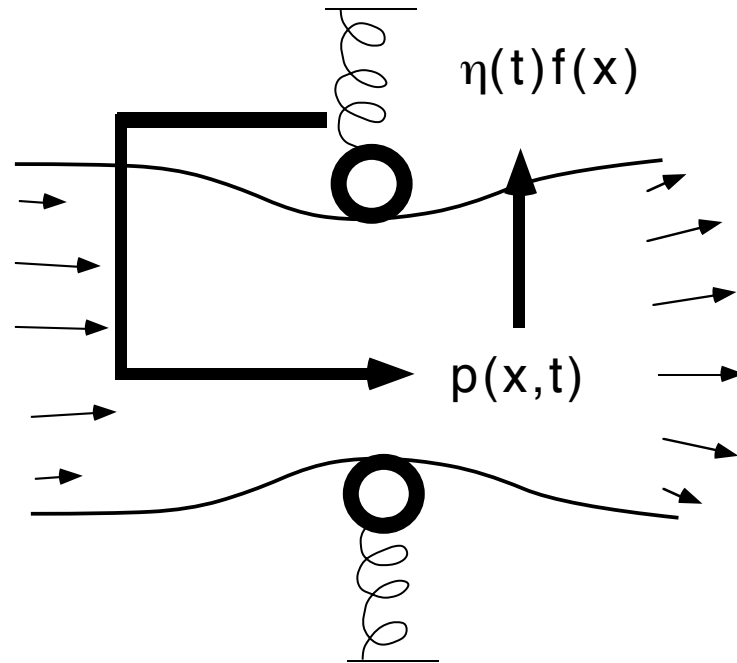

Newmark method for the spring:
prediction/ correction

$$\eta^n, \frac{\partial \eta^n}{\partial t} \xrightarrow{\text{fluid}} p$$

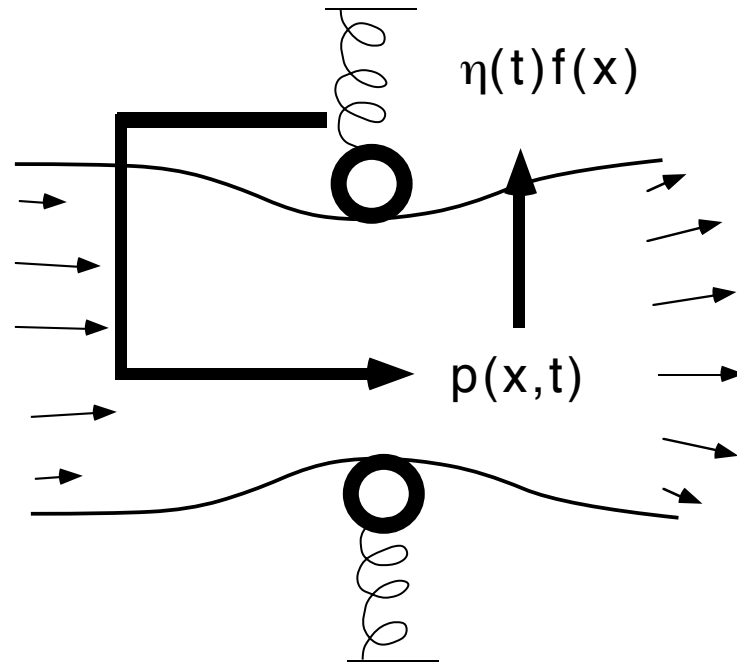

Newmark method for the spring:
prediction/ correction

$$\eta^n, \frac{\partial \eta^n}{\partial t} \xrightarrow{\text{fluid}} p$$

$$\eta^e, \frac{\partial \eta^e}{\partial t}$$

spring-prediction

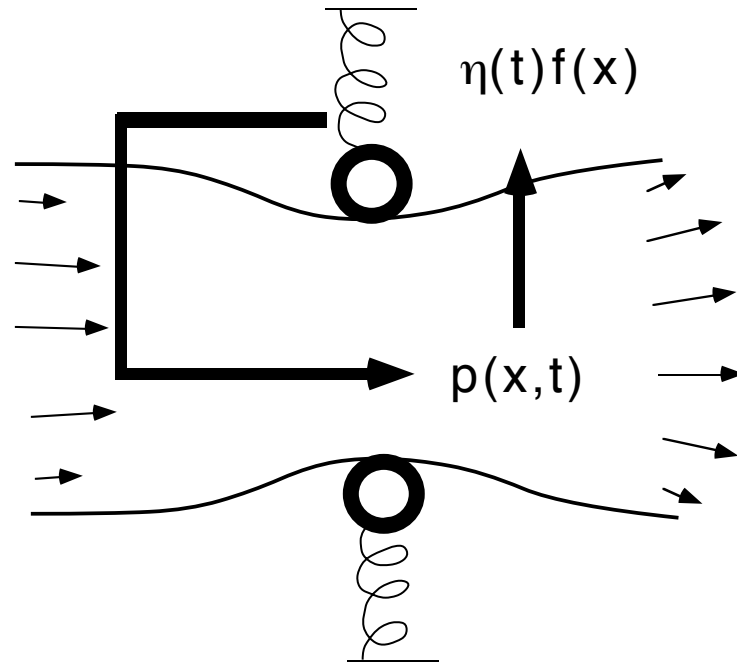

Newmark method for the spring:
prediction/ correction

$$\eta^n, \frac{\partial \eta^n}{\partial t} \xrightarrow{\text{fluid}} p \quad \eta^e, \frac{\partial \eta^e}{\partial t} \xrightarrow{\text{fluid}} p^e$$

spring-prediction

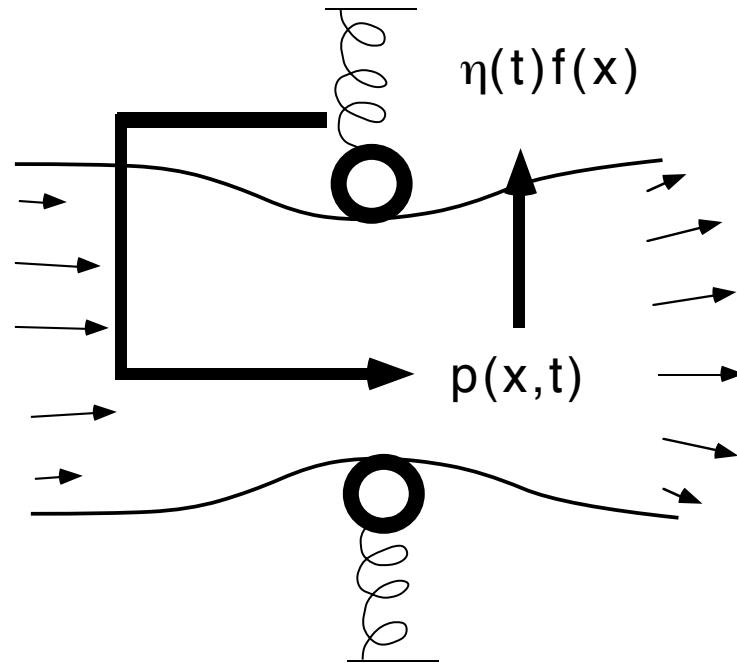

Newmark method for the spring:
prediction/ correction

$$\eta^n, \frac{\partial \eta^n}{\partial t} \xrightarrow{\text{fluid}} p$$

$$\eta^e, \frac{\partial \eta^e}{\partial t} \xrightarrow{\text{fluid}} p^e$$

$$\eta^{n+1}, \frac{\partial \eta^{n+1}}{\partial t}$$

spring-prediction

spring-correction

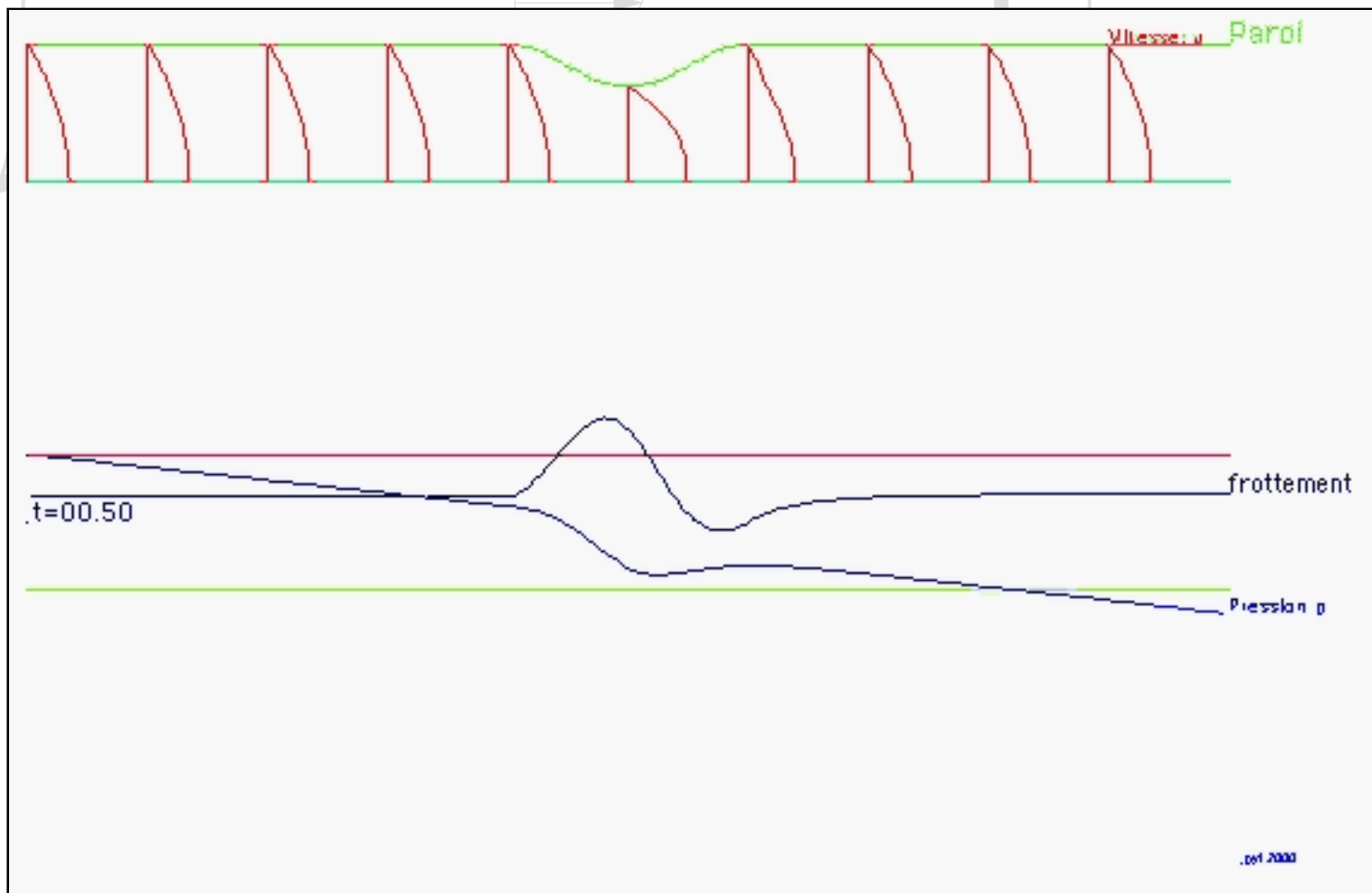
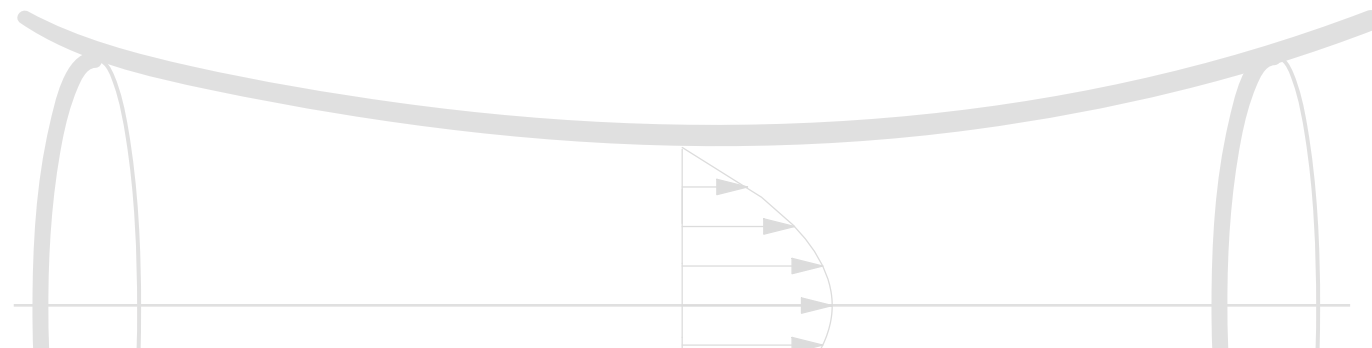

Example 7

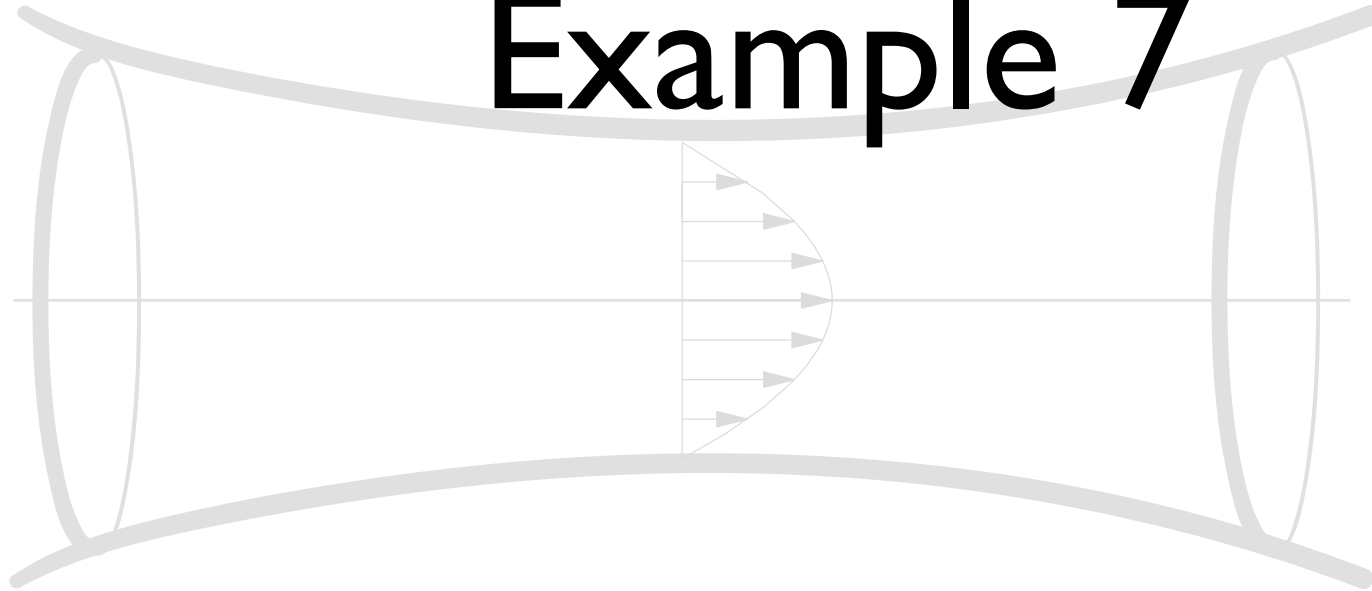

flow in arteries

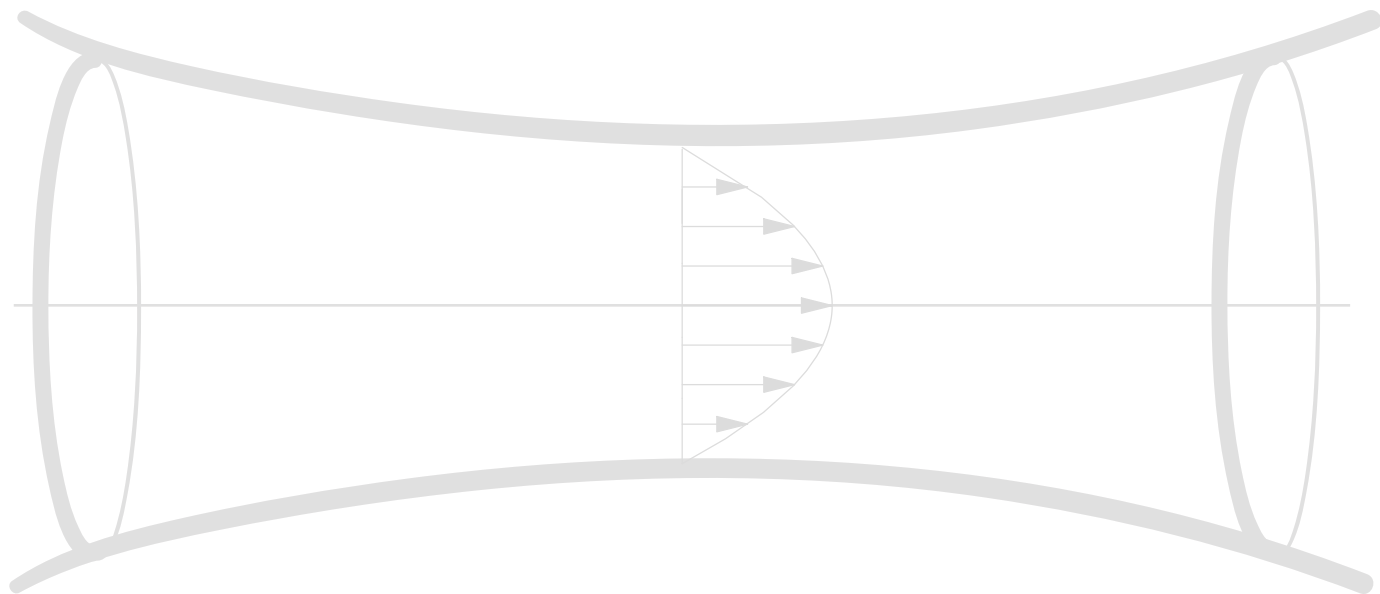

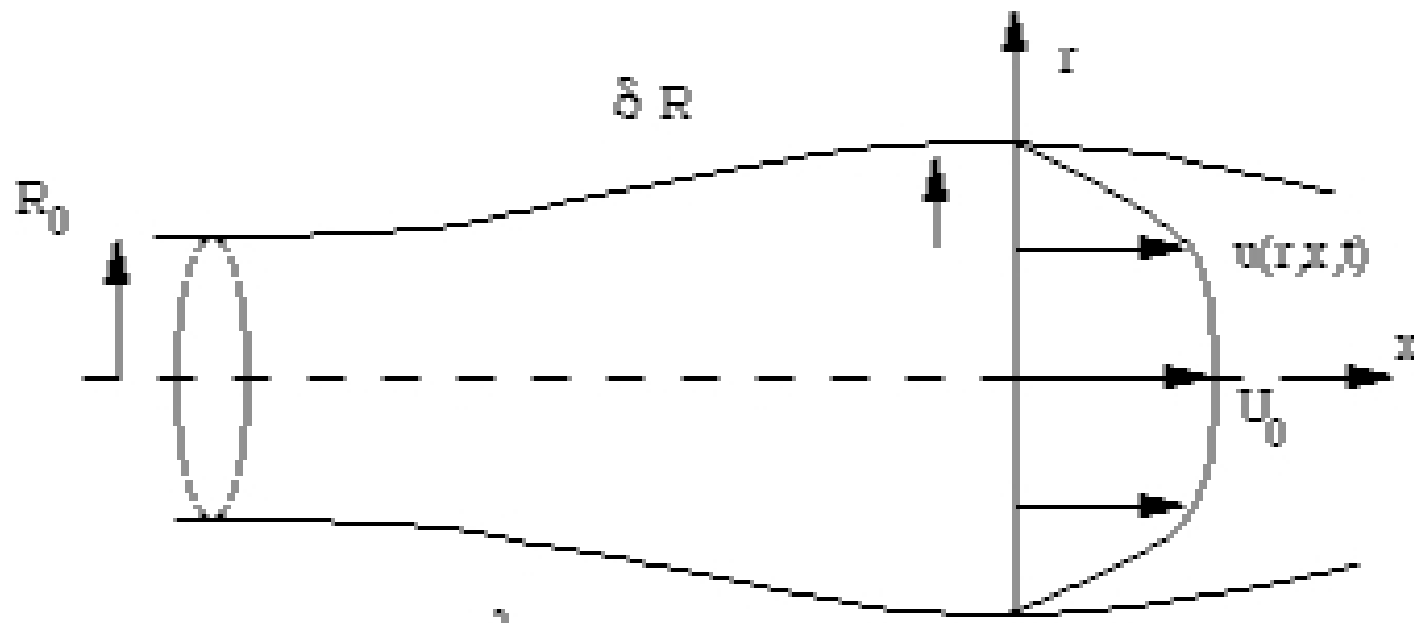

$$\frac{\partial}{\partial x}u + \frac{\partial}{r\partial r}rv = 0,$$

$$\frac{\partial u}{\partial t} + \varepsilon_2(u\frac{\partial}{\partial x}u + v\frac{\partial}{\partial r}u) = -\frac{\partial p}{\partial x} + \frac{2\pi}{\alpha^2 r}\frac{\partial}{\partial r}(r\frac{\partial}{\partial r}u), 0 = -\frac{\partial p}{\partial r}.$$

$$\varepsilon_2 = \frac{\delta R}{R_0}, \quad \alpha = R_0\sqrt{\frac{2\pi/T}{\nu}}$$

introducing wall elasticity: $p(x, t) = k(R(x, t) - R_0)$

+ The boundary conditions: here hyperbolic ($R(x_{in}, t)$ and $R(x_{out}, t)$) given

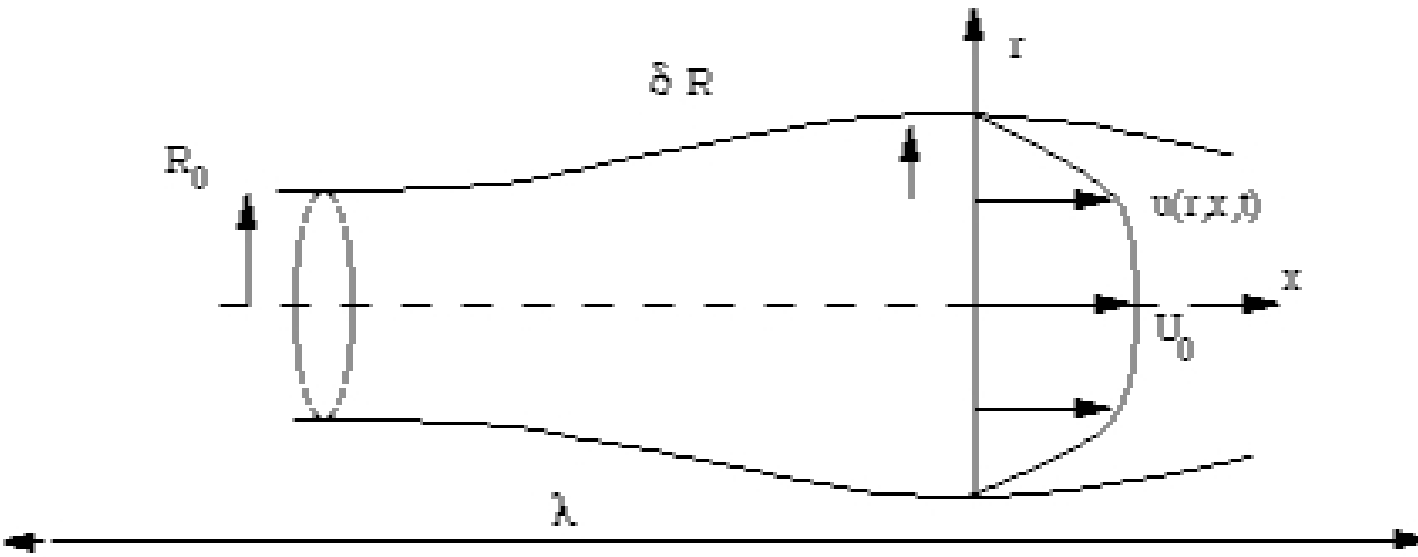

weak coupling

$$\frac{u^{n+1} - u^n}{\Delta t} + NL(u^n) = -\frac{\partial p^n}{\rho \partial x} + \nu \frac{\partial}{\partial r} r \frac{\partial u^{n+1}}{\partial r}$$

$$\nu^{n+1}(R^n) = - \int_0^{R^n} \frac{r}{R^n} \frac{\partial u^{n+1}}{\partial x} dr$$

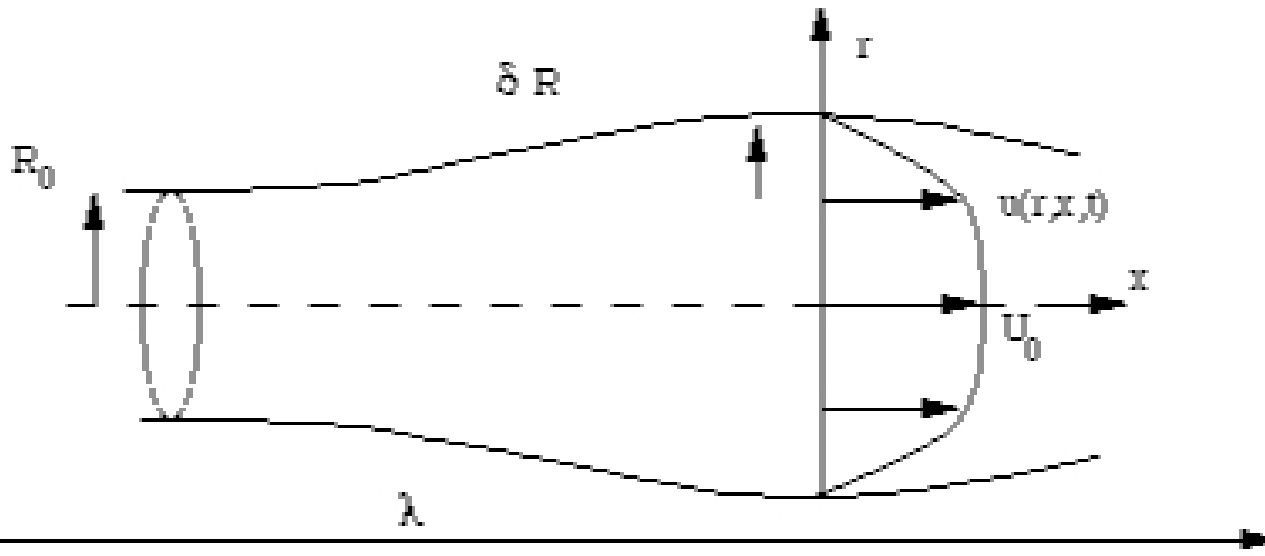

weak coupling

$$\frac{u^{n+1} - u^n}{\Delta t} + NL(u^n) = -\frac{\partial p^n}{\rho \partial x} + v \frac{\partial}{r \partial r} r \frac{\partial u^{n+1}}{\partial r}$$

$$v^{n+1}(R^n) = - \int_0^{R^n} \frac{r}{R^n} \frac{\partial u^{n+1}}{\partial r} dr$$

$$R^{n+1} = R^n + v^{n+1}(R^n) \Delta t$$

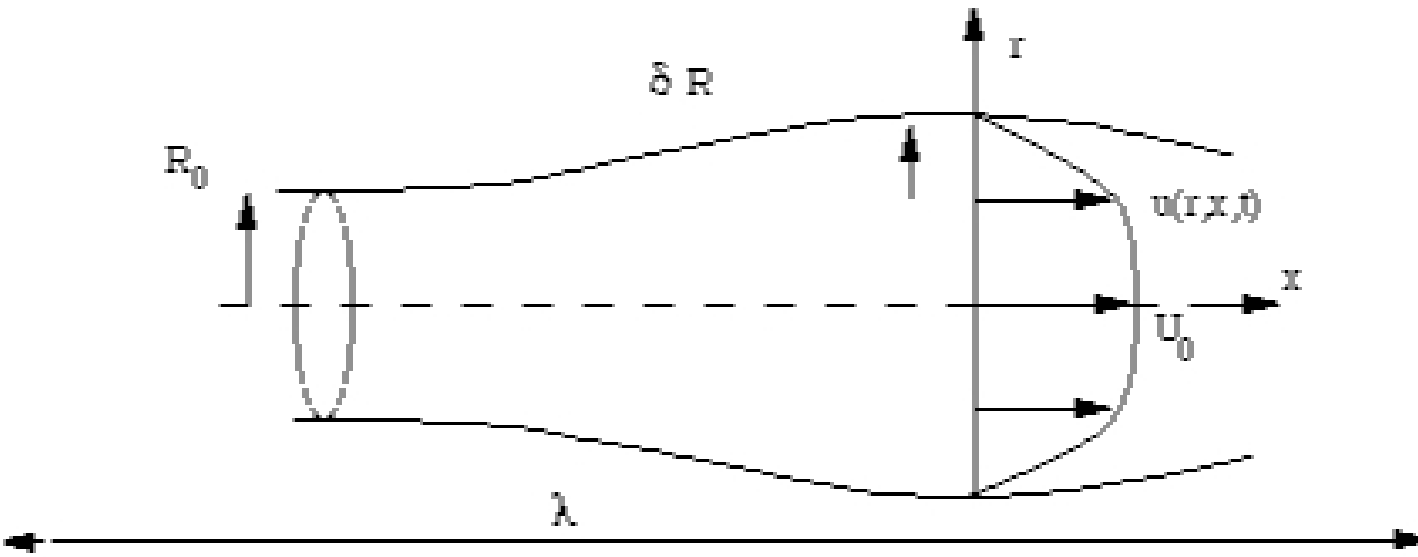

weak coupling

$$\frac{u^{n+1} - u^n}{\Delta t} + NL(u^n) = -\frac{\partial p^n}{\rho \partial x} + \nu \frac{\partial}{r \partial r} r \frac{\partial u^{n+1}}{\partial r}$$

$$v^{n+1}(R^n) = - \int_0^{R^n} \frac{r}{R^n} \frac{\partial u^{n+1}}{\partial x} dr$$

$$R^{n+1} = R^n + v^{n+1}(R^n) \Delta t \quad p^{n+1} = k(R^{n+1} - R_0)$$

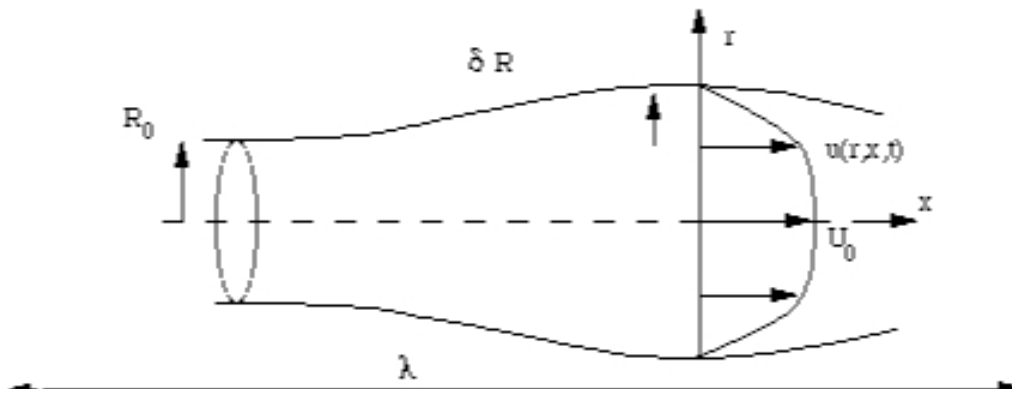

Flow in an elastic artery: integral relations

- new integral equations: adapting Von Kármán integral methods

The key is to integrate the equations with respect to the variable $\eta = r/R$ from the centre of the pipe to the wall ($0 \leq \eta \leq 1$).

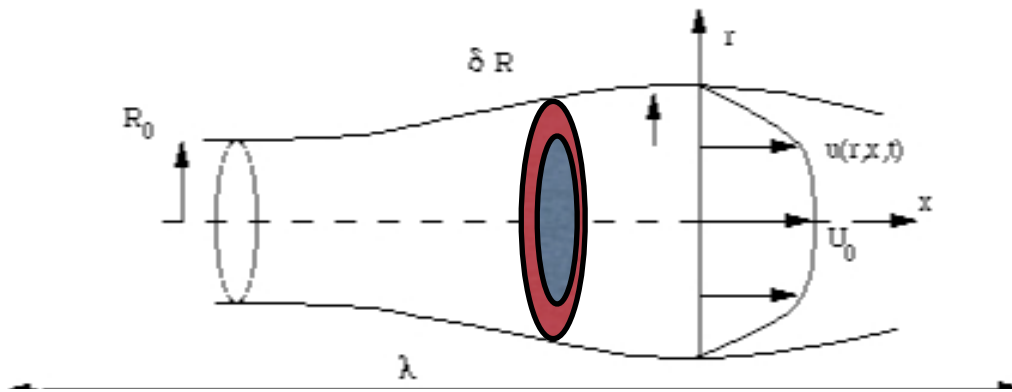

Flow in an elastic artery: integral relations

- new integral equations: adapting Von Kármán integral methods

The key is to integrate the equations with respect to the variable $\eta = r/R$ from the centre of the pipe to the wall ($0 \leq \eta \leq 1$).

- U_0 , the velocity along the axis of symmetry,

- q a kind of loss of flux (δ_1),

- Γ a kind of loss of momentum flux (δ_2):

$$U_0(x, t) = u(x, \eta = 0, t), \quad q = R^2(U_0 - 2 \int_0^1 u\eta d\eta) \quad \& \quad \Gamma = R^2(U_0^2 - 2 \int_0^1 u^2 \eta d\eta).$$

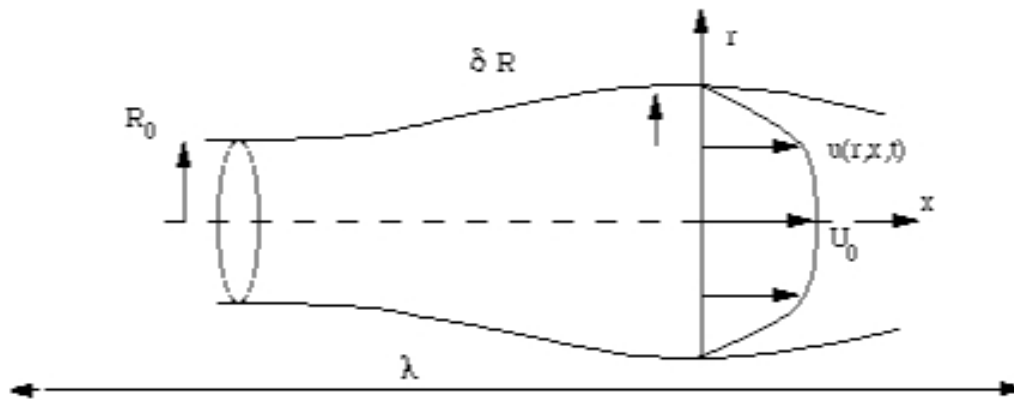

Flow in an elastic artery: integral relations

$$\frac{\partial R^2}{\partial t} + \varepsilon_2 \frac{\partial}{\partial x} (R^2 U_0 - q) = 0, \quad R = 1 + \varepsilon_2 h.$$

Integrating RNSP, with the help of the boundary conditions, we obtain the equation for $q(x, t)$:

$$\frac{\partial q}{\partial t} + \varepsilon_2 \left(\frac{\partial}{\partial x} \Gamma - U_0 \frac{\partial}{\partial x} q \right) = -2 \frac{2\pi}{\alpha^2} \tau, \quad \tau = \left(\frac{\partial u}{\partial \eta} \right) \Big|_{\eta=1} - \left(\frac{\partial^2 u}{\partial \eta^2} \right) \Big|_{\eta=0}.$$

From the same equation evaluated on the axis of symmetry (in $\eta = 0$), we obtain an equation for the velocity along the axis $U_0(x, t)$:

$$\frac{\partial U_0}{\partial t} + \varepsilon_2 U_0 \frac{\partial U_0}{\partial x} = -\frac{\partial p}{\partial x} + 2 \frac{2\pi}{\alpha^2} \frac{\tau_0}{R^2}, \quad \tau_0 = \left(\frac{\partial^2 u}{\partial \eta^2} \right) \Big|_{\eta=0}.$$

Boundary conditions ($h(x_{in}, t)$ and $h(x_{out}, t)$) given

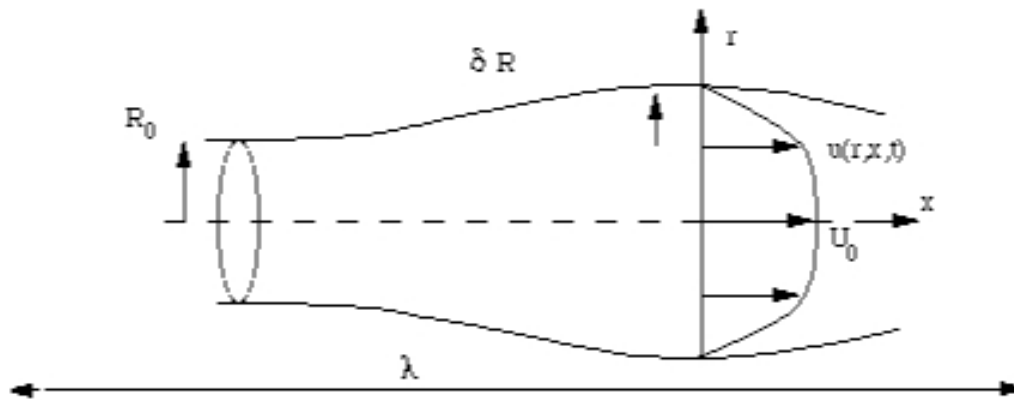

Closure

The two previous relations introduced the values of the friction in $\eta = 0$, the axis of symmetry: $((\frac{\partial^2 u}{\partial \eta^2})|_{\eta=0})$ and the skin friction in $\eta = 1$, at the wall: $((\frac{\partial u}{\partial \eta})|_{\eta=1})$.

- Information has been lost here, so we need a closure relation between (Γ, τ, τ_0) and (q, R, U_0) .

- we have to imagine a velocity profile and deduce from it relations linking Γ , τ and τ_0 and q , U_0 et R .

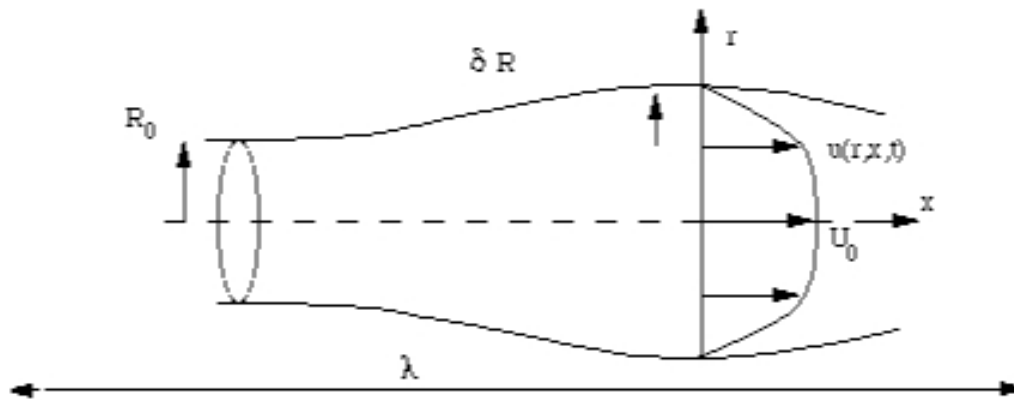

Closure: Womersley

- the most simple idea is to use the profiles from the analytical linearized solution given by Womersley (1955) for

$$(j_r + ij_i) = \left(\frac{1 - \frac{J_0(i^{3/2}\alpha\eta)}{J_0(i^{3/2}\alpha)}}{1 - \frac{1}{J_0(i^{3/2}\alpha)}} \right).$$

- assume that the velocity distribution in the following has the same dependence on η . It means that we suppose that the fundamental mode imposes the radial structure of the flow.

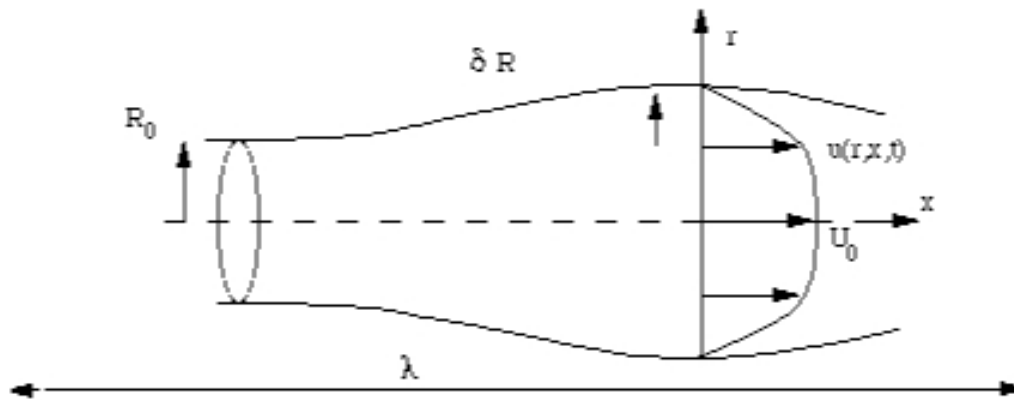

The coefficients of closure

- by integration/ derivation, we obtain:

$$\Gamma = \gamma_{qq} \frac{q^2}{R^2} + \gamma_{qu} q U_0 + \gamma_{uu} R^2 U_0^2, \quad \tau = \tau_q \frac{q}{R^2} + \tau_u U_0 \quad \tau_0 = \tau_{0q} \frac{q}{R^2} + \tau_{0u} U_0.$$

The coefficients $((\gamma_{qq}, \gamma_{qu}, \gamma_{uu}), (\tau_q, \tau_u), (\tau_{0q}, \tau_{0u}))$ are only functions of α .

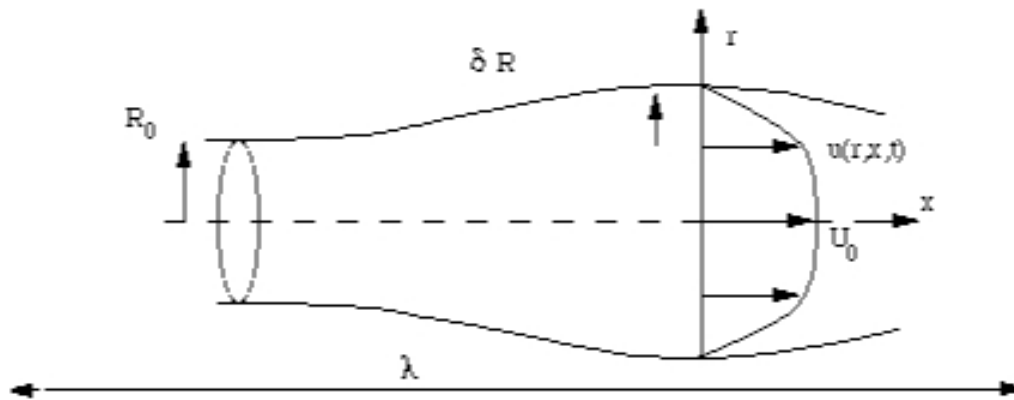

The coefficients of closure

- by integration/ derivation, we obtain:

$$\Gamma = \gamma_{qq} \frac{q^2}{R^2} + \gamma_{qu} q U_0 + \gamma_{uu} R^2 U_0^2, \quad \tau = \tau_q \frac{q}{R^2} + \tau_u U_0 \quad \tau_0 = \tau_{0q} \frac{q}{R^2} + \tau_{0u} U_0.$$

The coefficients $((\gamma_{qq}, \gamma_{qu}, \gamma_{uu}), (\tau_q, \tau_u), (\tau_{0q}, \tau_{0u}))$ are only functions of α .

$$\begin{aligned} \gamma_{uu} = & 1 - \int j_i^2 / (\int j_i)^2 - (2 \int j_r j_i) / \int j_i - \int j_r^2 + \\ & + (2 \int j_i^2 \int j_r) / (\int j_i)^2 + (2 \int j_i j_r \int j_r) / \int j_i - \\ & - (\int j_i^2 (\int j_r)^2) / (\int j_i), \end{aligned}$$

$$\tau_{0u} = \partial_{\eta}^2 j_{r\eta=0} + \partial_{\eta}^2 j_{i\eta=0} / \int j_i - (\partial_{\eta}^2 j_{i\eta=0} \int j_r) / \int j_i.$$

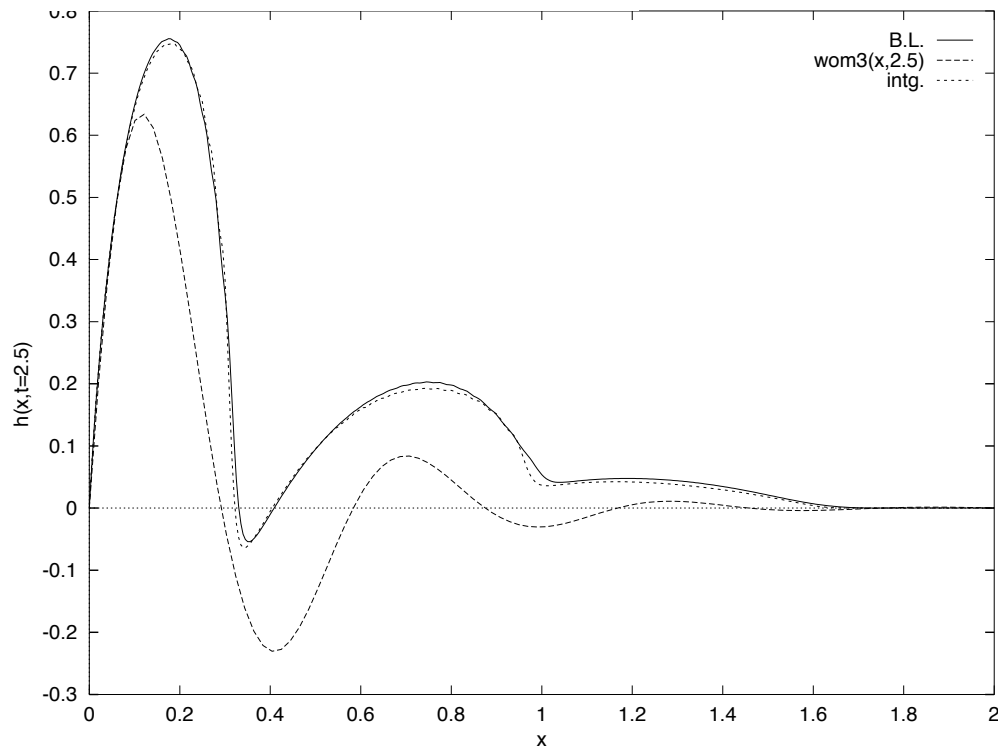
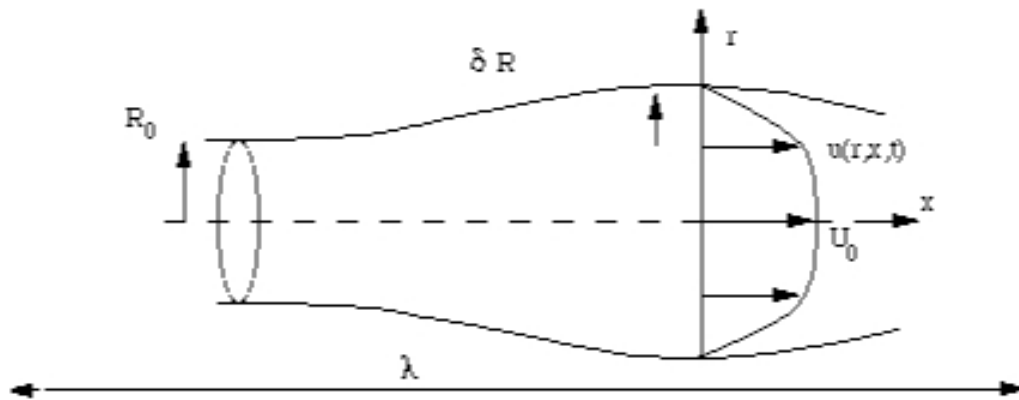
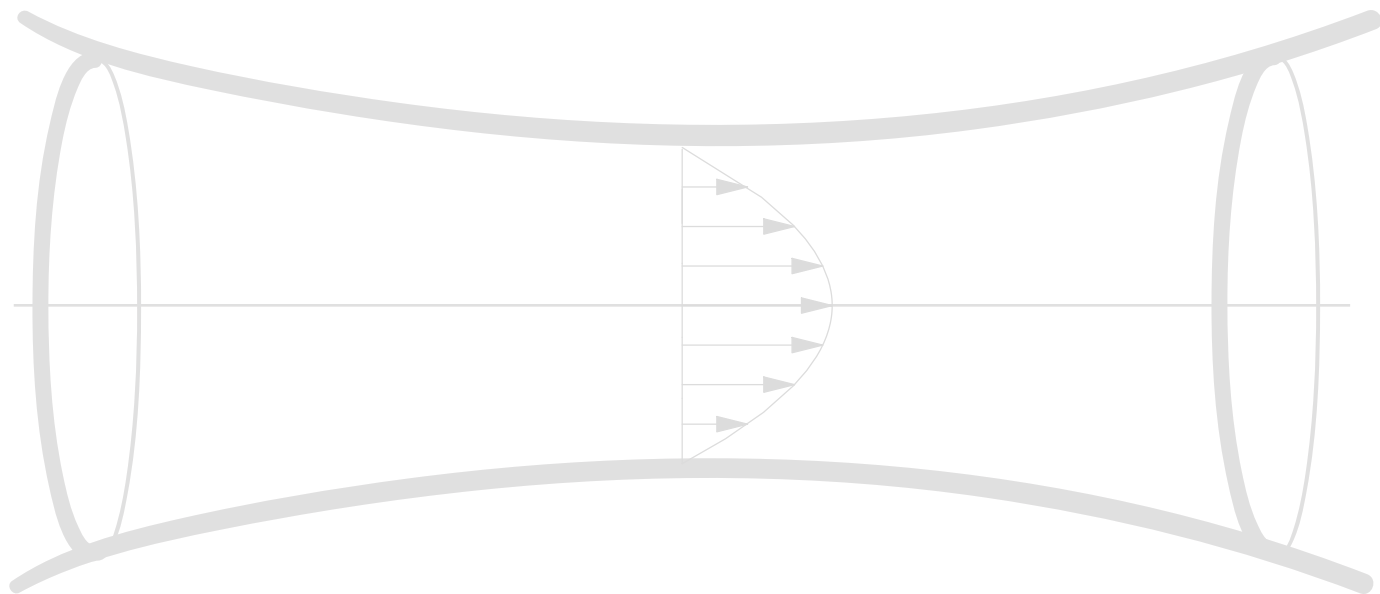

Figure 1: The displacement of the wall ($h(x, t = 2.5)$) as a function of x is plotted here at time $t = 2.5$. The dashed line ($wom3(x,2.5)$) is the Womersley solution (reference), the solid line (B.L.) is the result of the Boundary Layer code and the dots (intg) are the results of the integral method ($\alpha = 3$, $k_1 = 1$, $k_2 = 0$ and $\varepsilon_2 = 0.2$).



Conclusion



- starting from Navier Stokes
- set of simple equations RNSP
- set of more simple equations Integral
-
-
-
-

Conclusion

A decorative background featuring a grey lens-like shape with a horizontal axis. In the center, there is a diagram of a velocity profile with several horizontal arrows of varying lengths pointing to the right, representing a parabolic flow distribution.

- starting from Navier Stokes
- set of simple equations RNSP
- set of more simple equations Integral
- Good agreement with full Navier Stokes
-
-
-

Conclusion

A decorative background featuring a central lens-like shape with a horizontal axis. Inside the lens, there is a diagram of a velocity profile with several horizontal arrows of varying lengths pointing to the right, representing a flow field. The lens is framed by two curved lines that meet at the top and bottom.

- starting from Navier Stokes
- set of simple equations RNSP
- set of more simple equations Integral
- Good agreement with full Navier Stokes
- “explain” the features of the flow
- boundary conditions for full NS
- real time simulation

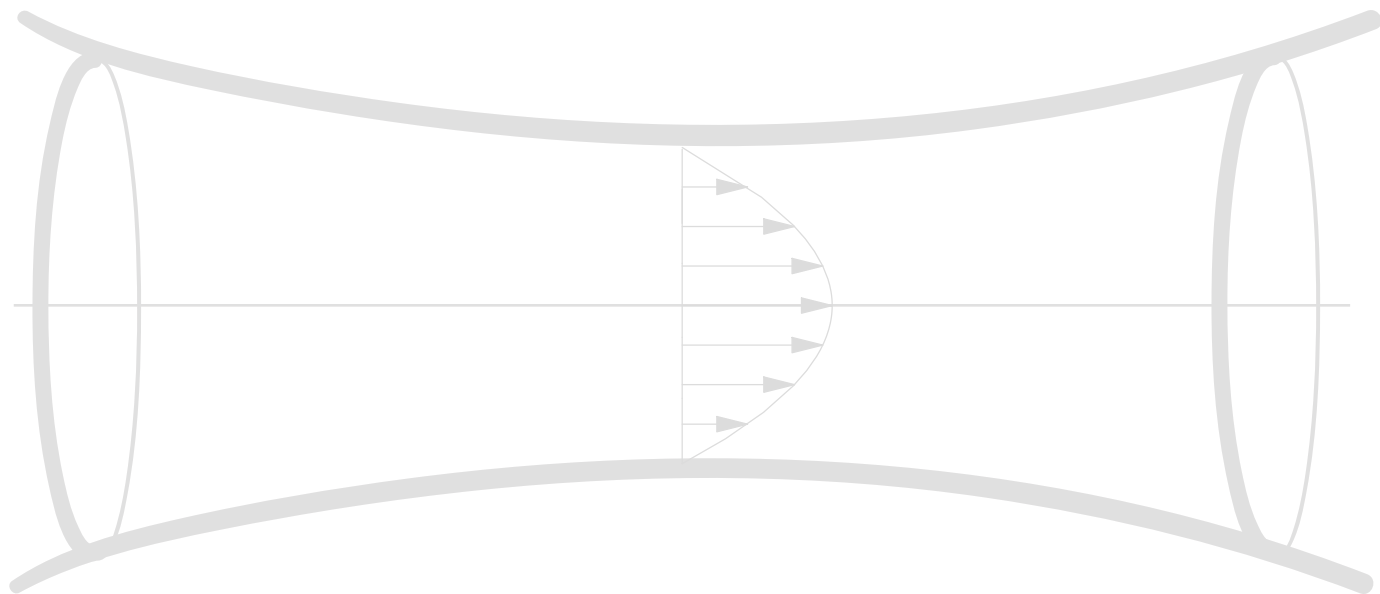

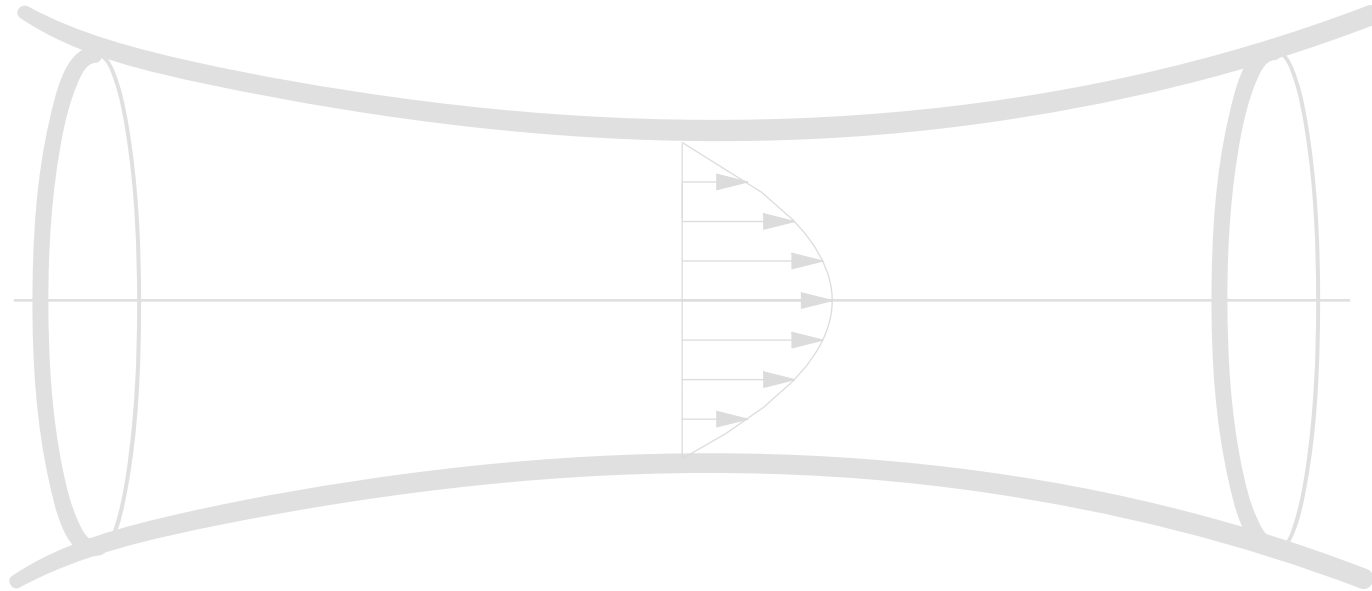

- Use Acrobat Reader 7.05 to see animations
- Updated version may be found here.

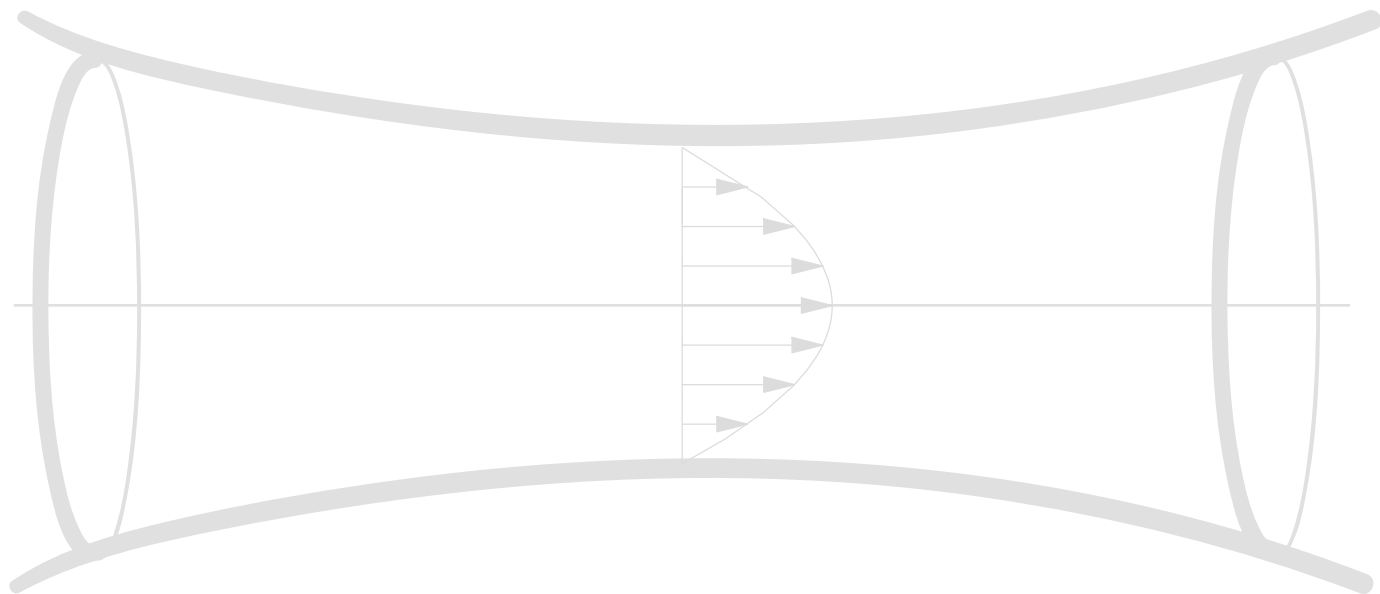

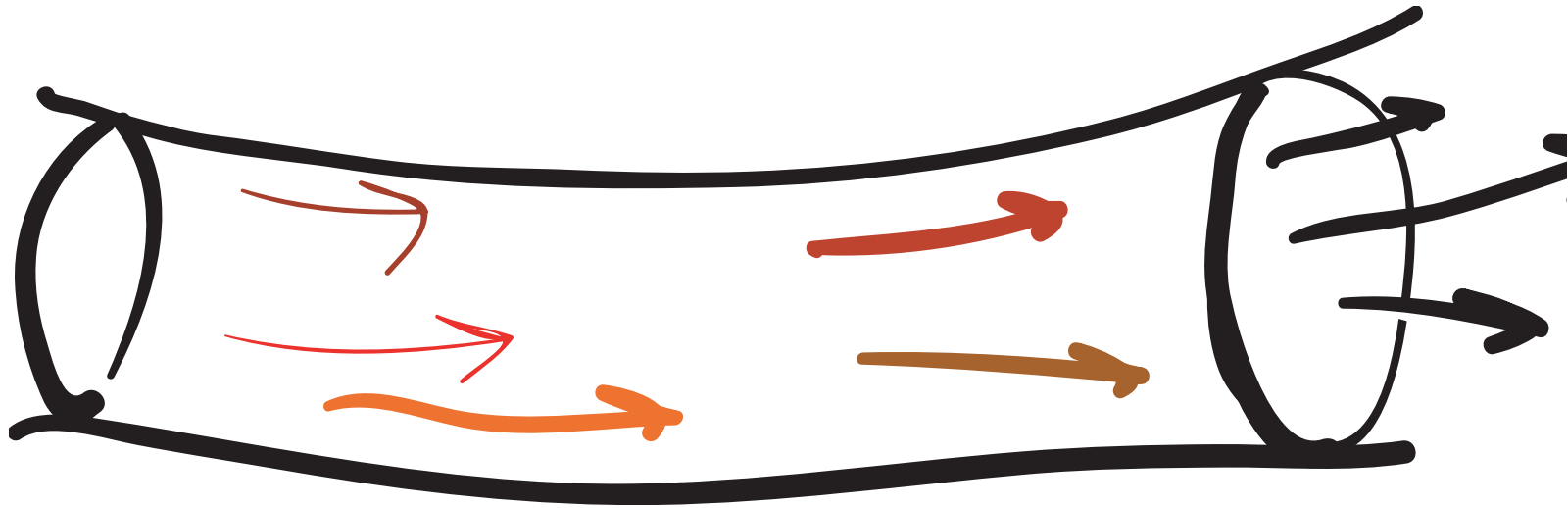

- Use Acrobat Reader 7.05 to see animations
- Updated version may be found here.